



# SPEKTRUM<sup>®</sup>

**3-Channel, 4-Model Memory  
DSM Racing System**



# Table of Contents

Alternate Languages.....	2
Introduction.....	3
DX3.0 Quick Start Setup.....	3
Direct Trim Access .....	5
DX3.0 with Digital Spectrum Modulation .....	6
Binding .....	6
Antenna.....	7
System Features.....	8
R/C Safety Precautions.....	8
Steering Tension Adjustment.....	8
Control Identification and Location .....	9
Charging Jack.....	10
Receiver Connections and Installation.....	11
Servo Layout.....	12
Key Input and Display .....	12
Display Screens .....	13
Accessing the System Mode .....	14
Model Select (System Mode).....	15
Model Name Entry (System Mode) .....	15
Auxiliary Channel 3 (System Mode).....	16
Grip Button C (System Mode).....	17
Data Reset (System Mode).....	19
Copy Model Data (System Mode) .....	19
Accessing the Function Mode .....	20
Throttle Deadband (Function Mode).....	21
Exponential (Function Mode).....	22
End-Point Adjust (Function Mode).....	23
Programmable Mixing (Function Mode) .....	24
Lap Timer (Function Mode).....	25
Sub-Trim (Function Mode).....	26
Servo Reversing (Function Mode).....	26
Accessing the Direct Trim Mode.....	27
Steering Trim (STC) .....	28
Throttle Trim (THC) .....	29
Grip Lever B: Steering Dual Rate Trim Adjustment STG.....	30
Grip Lever A: Brake Endpoint Adjustment BRG/ Channel 3 Access Brake Endpoint Adjustment.....	31
Channel 3 Access (Fuel Mixture) .....	32
Channel 3 Transmission Shift Selector (for vehicles with forward/reverse only) .....	32
DX3.0 Data Sheet.....	33
Warranty and Service Information .....	36
FCC Information.....	37

## Alternate Languages

- ITALIAN: Per la versione italiana di questo manuale vi preghiamo di visitare il sito [www.spektrumrc.com](http://www.spektrumrc.com)
- FRENCH: Pour consulter ce manuel en français, visiter le site [www.spektrumrc.com](http://www.spektrumrc.com)
- GERMAN: Zur Ansicht der Bedienungsanleitung in den Deutsch besuchen Sie bitte [www.spektrumrc.com](http://www.spektrumrc.com)
- SPANISH: Para ver este manual en Español entra en [www.spektrumrc.com](http://www.spektrumrc.com)

# Introduction

Thank you for purchasing Spectrum's DX3.0 radio system. The DX3.0 is designed to provide R/C racers with a bulletproof 2.4GHz spread spectrum radio link. With the DX3.0 DSM system you'll no longer have to wait for a frequency clip, worry about radio interference from noisy motors or ESCs or be concerned that someone may turn on a radio on your channel causing interference. In addition, the DX3.0's programming is user-friendly and offers the most important features and functions that racers demand. It's important that you carefully read this manual before attempting to operate your DX3.0 system. For your convenience, a blank data sheet has been included in the back of this manual. Once you have input all the necessary data for a particular model, we recommend that you write that information down on the data sheet provided. This insures that, in the rare case of a memory failure, you will not lose your models' setup data.

For those who would like to get out to the track quickly with just the basic radio setup, please refer to the Quick Start section that follows.

## DX3.0 Quick Start Setup

Included in this manual are in-depth instructions detailing all the steps and procedures needed to program each of the DX3.0's functions. For those racers who want to get to the track fast, we have provided the Quick Start section below. Quick Start covers the basic programming information necessary to get you racing right away.

Later, when you want to learn more about the specific functions of the DX3.0, refer to the appropriate page(s) in this manual for more detailed programming information.

**Note:** If braking adjustment via Grip Dial A is required, refer to the third channel system setup mode (page 31) for instructions.

## Binding

It's necessary to program the receiver to a specific transmitter so that the receiver will only recognize that transmitter, ignoring signals from any other sources. If the receiver is not bound to a transmitter, the system will not operate. Also, during the binding process, the servo fail-safe positions are set.

1. Make sure the transmitter and receiver are turned off.
2. With the receiver off, press and hold the bind button on the receiver while turning on the receiver.
3. Release the bind button when the LED flashes green.
4. With the transmitter off, Place the transmitter steering wheel, throttle trigger and auxiliary channels in their desired fail-safe positions (normally brake and straight-ahead steering).
5. Press and hold the bind button on the transmitter while turning on the transmitter.
6. Release the bind button after the green LED flashes.

After several seconds the LED on the receiver and the LED on the transmitter will quit flashing and remain solid, indicating that the binding process was successful. Once binding is complete, the system will automatically connect.

**Note:** See page 5 for a detailed description of the binding process.

# DX3.0 Quick Start Setup (continued)

## Servo Reversing



Indicates Current Channel  
 ST = Steering  
 TH = Throttle  
 AUX = Auxiliary Channel 3 (optional)

Indicates Current Servo Direction



1. With the transmitter power switch on, press the **SCROLL** key to enter the Function mode.
2. Press the **SCROLL** key until "REV.NORM" appears on the screen. The "ST" indicates the steering servo reversing screen.
3. Press the **INCREASE** or **DECREASE** key to move the cursor to the desired servo direction (REV.NORM).
4. Press the **CHANNEL** key once to access the throttle servo reversing screen.
5. To select the direction of the throttle servo, repeat Step 3 above.
6. Repeat Steps 2 and 3 to adjust Auxiliary Channel 3 if needed.

## End-Point (Travel) Adjustment

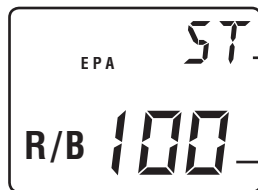

Indicates Current Adjustment Position  
 ST = Steering  
 TH = Throttle  
 AUX = Auxiliary Channel 3 (optional)

Indicates Current Value

L/F = Left/Forward  
 R/B = Right/Brake

1. From the Servo Reverse function, press the **SCROLL** key once to access the End-Point (Travel) Adjustment function (the EPA screen with "ST" will appear).

## Steering Adjustment

2. Rotate the steering wheel in the desired direction (left or right) to be adjusted.
3. Press the **INCREASE** or **DECREASE** keys to select the desired travel value.

## Throttle Adjustment

4. Press the **CHANNEL** key once. TH will appear on the screen.
5. Pull the trigger for forward or push the trigger for brake adjustment.
6. Press the **INCREASE** or **DECREASE** keys to select the desired travel value.

## Auxiliary Channel 3 Adjustment

- If a third channel is not required, proceed to Step 9.
7. Press the **CHANNEL** key once. "AUX" will appear on the screen.
  8. Press the **INCREASE** or **DECREASE** key to select the desired travel value.
  9. Press the **SCROLL** and **CHANNEL** keys at the same time to exit the function mode.

# DX3.0 Quick Start Setup (continued) Direct Trim Access

## Servo Trim Adjustment

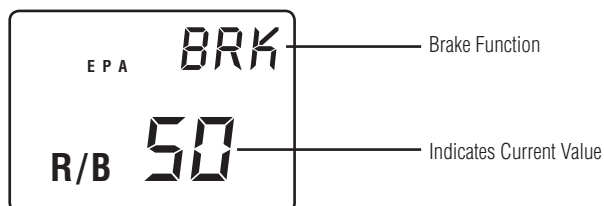
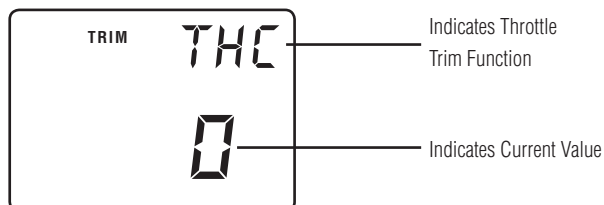
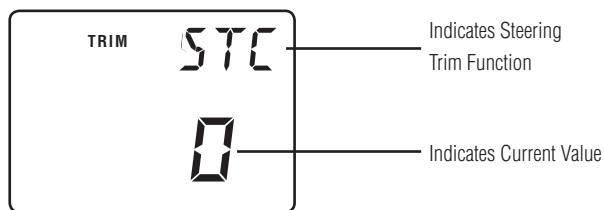

### Steering:

1. With the transmitter power switch on, move the digital steering trim lever in the desired position to be adjusted. The steering trim value screen will appear automatically.

### Throttle:

2. With the transmitter power switch on, move the digital throttle trim lever in the desired position to be adjusted. The throttle trim value screen will appear automatically.

### Auxiliary Channel 3 Servo (If Activated):

3. With the transmitter power switch on, move the digital Grip Lever A in the desired position to be adjusted. The Auxiliary Channel 3 value screen will appear automatically.

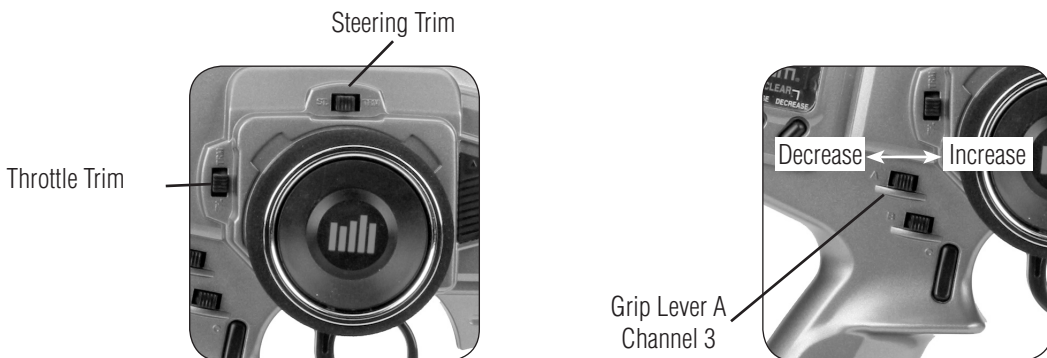

# DX3.0 with Digital Spectrum Modulation

The DSM® system operates in the 2.4GHz band (that's 2400MHz). This high frequency offers a significant advantage. as it's well out of the range of model-generated radio interference (like motor and ESC noise). All the complex issues that now exist using 27 and 75MHz radios with model-generated interfering noise are eliminated with this system. The DSM system uses Direct Sequencing Spread Spectrum modulation to generate a wide signal on a single frequency. The FCC requires that these systems be "smart"—incorporating collision avoidance such that when a system is turned on, it scans the 2.4GHz band and selects a channel that is not being used, then begins transmitting on that unused channel. 79 channels are available and the odds of one DSS spread spectrum system interfering with another are astronomically remote. The 2.4GHz spectrum has a capacity of 79 channels. In the unlikely event that the spectrum is full, the 80th system will not connect or cause any interference going into hold scan until a channel is free.

## Binding

During the first installation, the receiver(s) must be bound to the transmitter. Binding is necessary to program the receiver(s) to distinguish its corresponding transmitter from others. Also fail-safe positions are transferred from the transmitter to the receiver during binding.

It is necessary to bind the receiver to the transmitter during the first installation, and is recommended when the receiver is moved from one vehicle to another. Receivers can be re-bound to the same transmitter or to other transmitters an infinite number of times. Also multiple receivers can be bound to a single transmitter, common when using one transmitter to operate several models.

Only bound receivers and transmitters can connect. During power-up, the transmitter scans for a free channel while the receiver scans for its bound transmitter. During the scanning process, LEDs on both the transmitter and receiver flash rapidly. When control is achieved, the LED remains on continuously.

In the unlikely event that the link is lost during use, the receiver will drive the servos to their fail-safe positions that were preset during the binding process. If the receiver is turned on prior to turning on the transmitter, the receiver will enter the fail-safe mode, driving the servos to their preset fail-safe position. When the transmitter is turned on, normal control is resumed.

## To bind the receiver to the transmitter

1. Make sure the transmitter and receiver are turned off

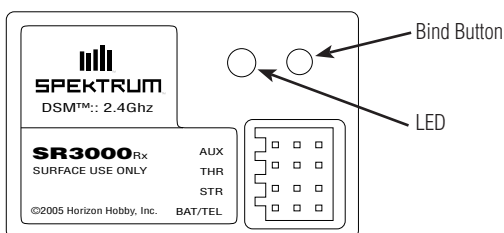

2. With the receiver off, press and hold the bind button on the receiver while turning on the receiver.
3. Release the bind button when the LED flashes green.

## Binding (continued)

4. With the transmitter off, place the transmitter steering wheel, throttle trigger and auxiliary channels in their desired fail-safe positions (normally brake and straight-ahead steering).

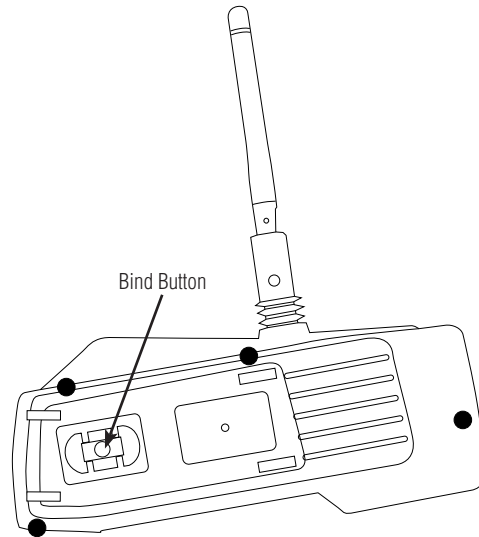

5. Press and hold the bind button on the transmitter while turning on the transmitter.
6. Release the bind button after the green LED flashes.

After several seconds the LED on the receiver and the LED on the transmitter will quit flashing and remain solid, indicating that the binding process was successful. Once binding is complete, the system will automatically connect.

## Antenna

At 8.5 inches in length, the receiver antenna is significantly shorter than conventional antennas. The receiver has provisions that allow the antenna to exit the top of the receiver or at the end of the receiver. To switch antenna positions, it is necessary to open the case to change the antenna exit position. Like all antennas, it's important to mount the antenna vertically. In most cases the antenna can be mounted inside the body with no loss of range. Mount the receiver antenna as recommended by the manufacturer of the vehicle, however, it may be necessary to trim the plastic antenna tube (included with your vehicle) to allow the antenna to extend at least 1/2" past the tip of the tube.

**Note:** If desired, the antenna can be shortened (cut) to exactly 3.6" with negligible loss of range, and in some applications the short 3.6" length will make installation easier.

## System Features

- DSM 2.4GHz Spread Spectrum Modulation
- Three channels
- Easy-to-read LCD graphics display
- Four-model memory
- Three-character model name entry
- Electronic digital trim levers for throttle and steering
- Two assignable electronic grip levers
- Third channel accessible through Grip Dial A
- Direct display trim function
- Sub-trim
- Steering rate adjustment
- Independent steering endpoint adjustments
- Brake/throttle endpoint adjustment
- Low battery alarm
- Charge jack receptacle (rechargeable batteries not included; order JRPB958)

## R/C Safety Precautions

For safe and reliable performance of your R/C model, please carefully read and follow these guidelines:

1. Radio control models are not toys. They are capable of inflicting serious injury to people and property. Use caution at all times when operating your model.
2. You are responsible for the safe operation of your R/C model. You must properly install, test and operate your model with a clear sense of that responsibility. Do not take risks that might endanger yourself or others.
3. Running an R/C car in the streets is very dangerous to both drivers and models. Avoid running your model in areas occupied by full-size automobiles. To locate areas where you can safely operate your model, you should contact your local hobby shop for R/C tracks or clubs in your area.
4. When running an R/C boat, keep it away from any swimmers, full-size boats, or wildlife. Also, watch carefully for fishing lines that can get tangled in the propeller.
5. If at any time while operating your RC model you observe abnormal model functioning, end your operation immediately. Do not operate your model again until you are certain the problem has been corrected.

**CAUTION:** Control of your model is impossible without sufficient voltage for the transmitter and receiver. A weak transmitter battery will decrease your range of operation and a weak receiver battery will slow servo movement and decrease your range of operation. Check your receiver pack voltage often to avoid losing control of your model.

## Steering Tension Adjustment

Steering tension is adjustable via the recessed screw located beneath the steering wheel (see page 9 for exact location). Turning the screw clockwise increases the steering tension.



# Control Identification and Location



\* To remove the Battery Cover, press down on the ridges and push the cover in the direction of the arrow. Remove the battery cover and install 8 "AA" batteries in the direction as molded into the battery case. If the transmitter voltage fails to register, check for correct battery installation and review voltage again.

# Charging Jack

Located on the left-hand side of the transmitter is the charging jack, which accepts only JR® or Spektrum style wall chargers. Please do not attempt to use any other brand of wall charger as it may be reverse polarity and can cause damage to your system. Only use the JR or Spektrum type wall charger when the DX3.0 is equipped with Ni-Cd batteries.

## Spektrum Transmitter Charge Jack Polarity:



### Charger Pigtail For Transmitter

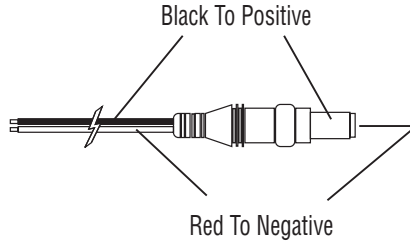

# Receiver Connections and Installation

**Note:** When using a separate Ni-Cd receiver battery as a power source, the operating voltage range is 4.8–6.0V (4–5 cells) underload.

**Attention:** Make sure the male and female connectors have the correct polarity (+/–) before connecting. Be sure to orient the servo plug correctly for proper insertion.

Most electronic speed controllers are set up for Battery Eliminator Circuit (B.E.C.) operation and plug directly into your receiver. See Figure A for a typical setup and check your speed controller’s manual for correct installation.

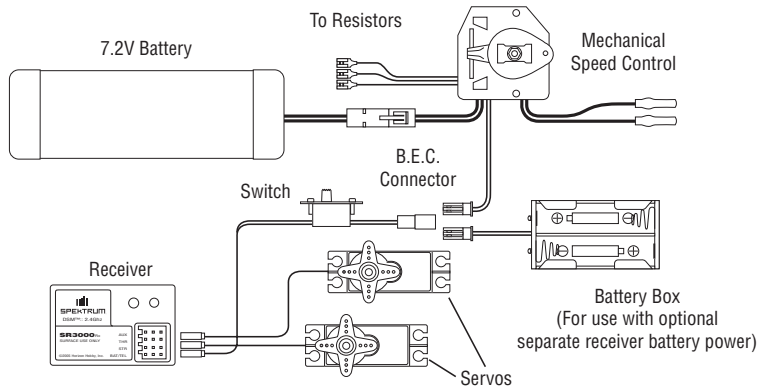

**Figure A** – Connections to B.E.C. and receiver with mechanical speed controller. Ni-Cd battery and speed controller are not included in the radio set.

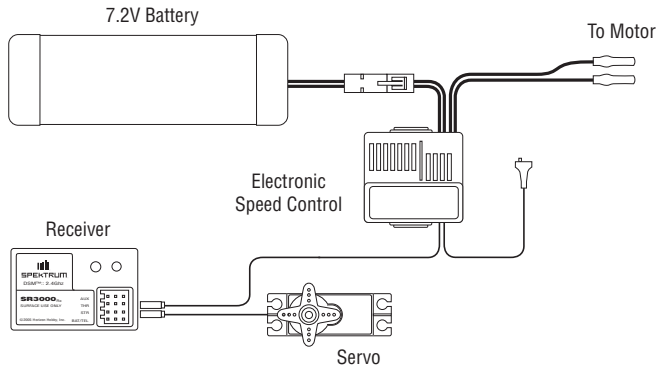

**Figure B** – Connections to B.E.C. and receiver with electronic speed controller. Ni-Cd battery and speed controller are not included in the radio set.

# Servo Layout

**Note:** Rubber grommets (and sometimes eyelets) are used in fuel-powered vehicles.

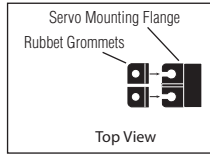
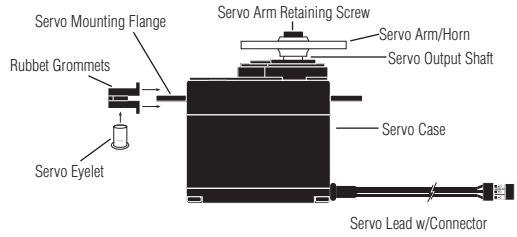

# Key Input and Display

Key	Use
SCROLL	Used to move up through the available functions
CHANNEL	Used to select the desired channel
INCREASE	Used to increase the value of the selected function
DECREASE	Used to decrease the value of the selected function

To enter the System Mode press the **SCROLL** and **CHANNEL** keys simultaneously and hold while turning on the transmitter.



To enter the Function Mode, press the **SCROLL** key while the transmitter is on.



Press the **INCREASE** and **DECREASE** keys simultaneously to clear the screen or return to factory preset.

# Display Screens

## Normal Display Screen

When the power switch is turned on, the LCD screen will read as shown below. This screen is referred to as the Normal Display.

**Note:** If any of the electronic trim buttons are moved while in this screen, the screen will automatically change to display the trim in use. This is called the Direct Trim Mode. For more information on the feature, please see page 7 of this manual.



## Low Battery Screen/Lithium Battery Backup

When the voltage of the eight "AA" batteries drops below 9.0 volts, the DX3.0's display screen will alternate between the Normal (see above) and Low Battery screen (BAT), and a continuous beeping will occur, indicating that the batteries need to be replaced before further use.

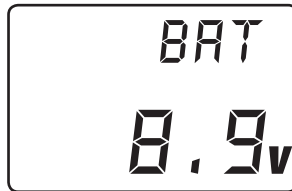

## Lithium Battery

Your DX3.0 radio system is equipped with a five-year lithium battery backup system. This system is designed to protect and retain all radio programming in the event that the transmitter batteries drop below the required 9.0 volts, or the transmitter battery case is removed during battery changes. If after five years it becomes necessary to replace the lithium battery, return your system to the Horizon Service Center for repair (see address, page 36).

## Memory Backup Screen

If the Memory Backup screen appears, this indicates the possibility of a memory issue or the lithium battery is dead. If you switch the power off and on again, and transmitter is in the default mode with all data lost, it is suggested that the DX3.0 transmitter be returned to the Horizon Service Center for servicing (see Warranty Information, page 36).



# Accessing the System Mode

To enter the System Mode, press both the **SCROLL** and **CHANNEL** keys at the same time while turning on the transmitter power switch. By pressing the **SCROLL** key, you can now choose Model Select, Model Name Input, Auxiliary Channel 3, Grip Button C function, Data Reset of the Model Copy function as shown here on the System Mode flow chart. Information for each function is located on the page number listed next to the function name on the flow chart.

To exit the System Mode, press the **SCROLL** and **CHANNEL** keys at the same time, or simply turn off the transmitter.

**Note:** If you turn the transmitter off and immediately enter System mode again, you will be returned to the last System mode function used instead of the Model Select function. While in System mode, there is no RF output generated by the transmitter. adjustments can be performed with reduced battery power consumption. If you exit System mode by pressing the **SCROLL** and **CHANNEL** key at the same time, RF output will not be enabled until you first turn off the transmitter.

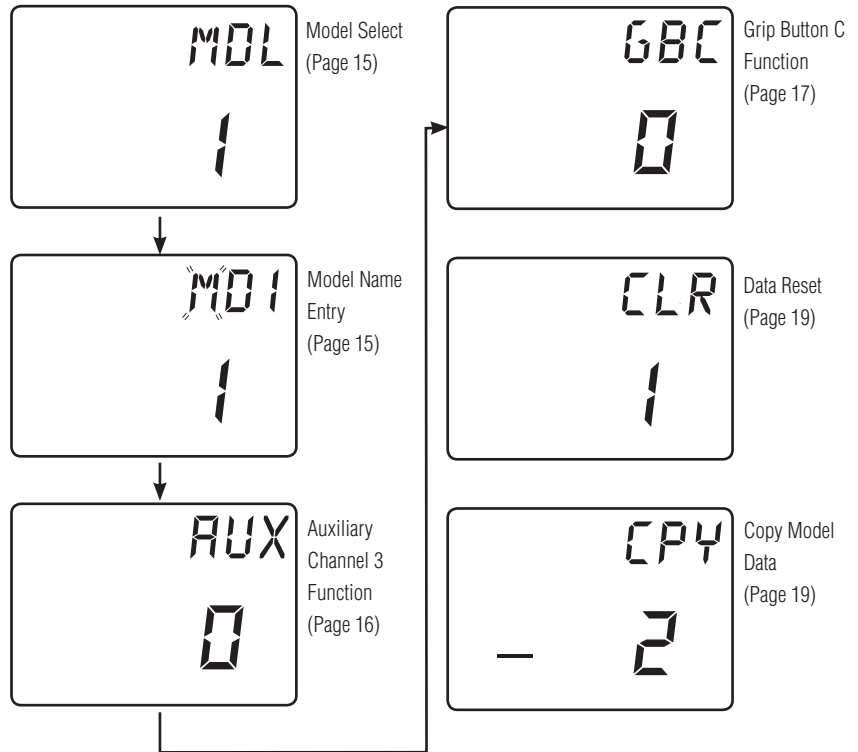

## Model Select (System Mode)

The DX3.0 has memory for four models. This feature allows for four different models to be operated with the same transmitter (additional receivers and servos must be purchased separately) or one model with four different race setups.

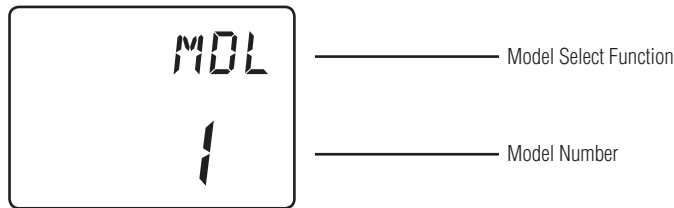

### Accessing the Model Select Function

1. Press the **SCROLL** and **CHANNEL** keys at the same time and hold.
2. Turn the transmitter power switch on to enter System Mode.
3. If "MDL" does not appear on the screen, press the SCROLL key until MDL appears.
4. Press the **INCREASE** or **DECREASE** keys to select the desired model number (1, 2, 3, or 4).
5. Press the **SCROLL** key to access the Model Name Entry function.
6. To exit the System Mode, either turn the transmitter power switch off or press the **SCROLL** and **CHANNEL** keys at the same time.

## Model Name Entry (System Mode)

The DX3.0 allows a three-character name to be input for each of the four models available. The current model, with name, will then be displayed in the Normal display screen. This feature is useful to help identify different models, setups, etc. For information on selecting models 1, 2, 3 or 4, please refer to the Model Select function above.

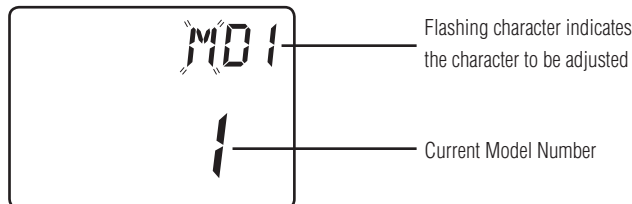

### Accessing the Model Name Entry Function

1. Press the **SCROLL** and **CHANNEL** keys at the same time and hold.
2. Turn on the transmitter power switch to enter the System Mode.
3. "MD1" should now be present on the screen.
4. Press the **INCREASE** or **DECREASE** keys to select the correct letter/number for the first character (flashing).
5. To change the remaining two characters, press the **CHANNEL** key until the desired character to be changed is flashing.
6. Press the **SCROLL** key to access the Auxiliary Channel 3 function.
7. To exit the System Mode, either turn the transmitter power switch off or press the **SCROLL** and **CHANNEL** keys at the same time.

# Auxiliary Channel 3 Function Select (System Mode)

The Auxiliary Channel 3 function of the DX3.0 allows you to select from 2 different types of Channel 3 servo travel movements, or to inhibit the Auxiliary Channel 3 function. Use the information below to select the correct Auxiliary Channel 3 function type for your particular installation. It is suggested the 0 function (factory preset) be selected for most applications.

**LN** = The LN, or linear, servo travel function is designed to be used when an engine fuel mixture servo is required. This function is most commonly used with gas-powered R/C racing boats and is accessible through the Grip Dial A. In this function, the maximum travel of the servo is determined by the End-Point Adjust function, page 23. The servo neutral position can be altered proportionately via the Grip Dial A for fuel mixture adjustment. When activated, fuel mixture trim values are visible for the Direct Trim function, page 27.

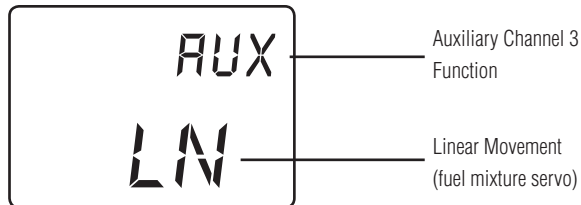

**2P** = The 2P, or 2 position, Servo Travel function is designed to be used as a transmission gear shift channel. This feature is designed for use only with vehicles such as the Traxxas® T-Maxx. This function is accessible through the Grip Button C or Grip Dial A if Grip Button C is occupied by another function. In this function, the servo's travel can be selected to only three positions: left, center and right. The left and right travel values are determined by the End-Point Adjustment function, page 23.

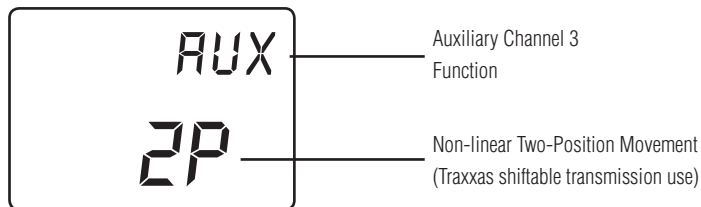

**0** = The 0 or Inhibit function allows the Brake End-Point Adjustment function, page 31, to be used. This function is designed to be used with most types of electric and gas-powered RC cars. This feature is extremely popular, as it allows the amount of panic braking accessible through the throttle trigger's braking position to be adjusted during operation for maximum effectiveness. When activated, the braking valves will be visible via the Direct Trim function, page 27.

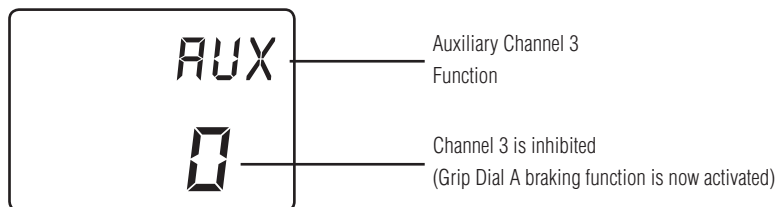



# Auxiliary Channel 3 Function Select (System Mode) continued

## Accessing the Auxiliary Channel 3 Function

- LN = Linear servo movement
- 2P = 2-position servo movement
- 0 = Inhibited (Grip Dial A Braking is now activated)

1. Press the **SCROLL** and **CHANNEL** keys at the same time and hold.
2. Turn on the transmitter power switch to enter the System Mode.
3. Press the **SCROLL** key until "AUX" appears on the screen.
4. Press the **INCREASE** or **DECREASE** key to select the correct Auxiliary Channel 3 function type to be used.
5. Press the **SCROLL** key to access the Grip Button C Select function.
6. To exit the System mode, either turn the transmitter power switch off or press the **SCROLL** and **CHANNEL** keys at the same time.

# Grip Button C Function Select (System Mode)

The Grip Button C function of the DX3.0 allows you to select from 3 different functions available. Use the information below to select the correct Grip Button C assignment for your particular installation.

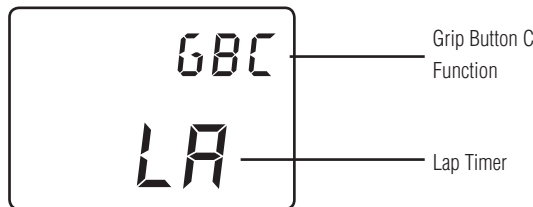

- "0": Off. (Default) If "AUX" is "2P", then "2P" replaces "0" in this screen.
- "Eb": ESB (Emergency Steering Button). To cancel the "STG" regulation for panic steering.
- "LA": Lap Timer.

**Note:** If "LA" or "Eb" is selected and "2P" is assigned to the Auxiliary Channel 3 function, the Auxiliary Channel 3 function is moved to Grip Dial A (factory preset).

2P = The 0 or off function, is the default setting and does not assign a function to Grip Button C. If the Auxiliary Channel 3 function is set to "2P" or 2-position, "2P" will appear in this screen in place of "0" and Grip Button C will function as the gear select button.

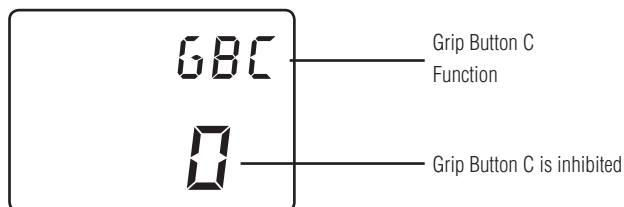

# Grip Button C Function Select (System Mode) continued

**Eb** = The Eb or Emergency Steering Button function is designed to override the value of Grip Dial B and provide 100% steering rate. This feature is useful if you have reduced the steering rate to make your vehicle easier to drive but need full steering in an emergency situation such as a collision.

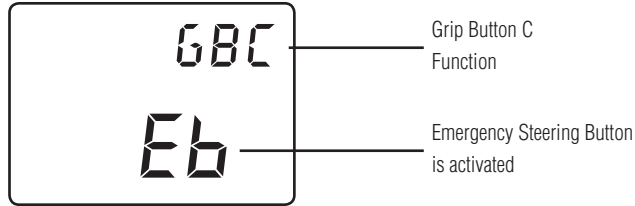

**LA** = The LA or Lap Timer function is designed to be used when you want to enable the recording of individual lap time. The Lap Timer function is described on page 25..

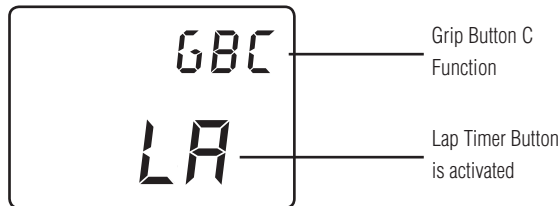

1. Press the **SCROLL** and **CHANNEL** keys at the same time and hold.
2. Turn on the transmitter power switch to enter the System Mode.
3. Press the **SCROLL** key until "GBC" appears on the screen.
4. Press the **INCREASE** or **DECREASE** key to select the correct Grip Button C function type to be used.
5. Press the **SCROLL** key to access the Data Reset function.
6. To exit the System mode, either turn the transmitter power switch off or press the **SCROLL** and **CHANNEL** keys at the same time.

## Data Reset (System Mode)

The Data Reset function allows you to reset all the programming in the selected model (1, 2, 3 or 4) to the factory default settings and to copy model data from one model memory to another. Before using the Data Reset function, it's important to enter the Model Select function and check to make sure the current model number indicated (1, 2, 3 or 4) is the model to which you want to reset to the factory default settings. The Model Select function is described on page 15.

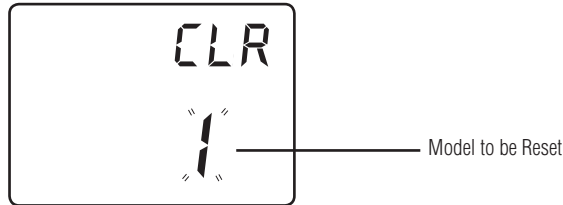

## Accessing the Data Reset Function

1. Press the **SCROLL** and **CHANNEL** keys at the same time and hold.
2. Turn on the transmitter power switch to enter the System Mode.
3. Press the **SCROLL** key until "CLR" appears on the screen.
4. Press the **INCREASE** or **DECREASE** keys at the same time to reset the data. To confirm that the selected model's programming has been reset, a beep will sound and the model number selected (1, 2, 3 or 4) will stop flashing.
5. Press the **SCROLL** key to access the Copy Model Data function.
6. To exit the System mode, either turn the transmitter power switch off or press the **SCROLL** and **CHANNEL** keys at the same time.

## Copy Model Data (System Mode)

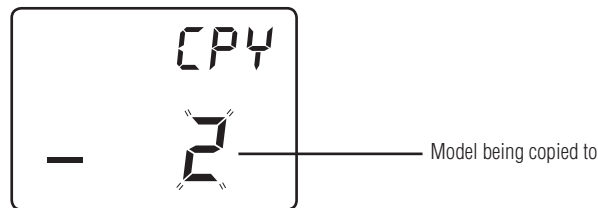

## Accessing the Copy Model Data Function

1. Press the **SCROLL** and **CHANNEL** keys at the same time and hold.
2. Turn on the transmitter power switch to enter the System Mode.
3. Press the **SCROLL** key until "CPY" appears on the screen.
4. Press the **INCREASE** or **DECREASE** key to select the desired model number you want the current model data copied to. The selected model number should be flashing.
5. Press the **INCREASE** and **DECREASE** keys at the same time to copy the current model data into the selected model number. To confirm that the selected model has been copied to, a beep will sound and the model number selected (1, 2, 3 or 4) will stop flashing.
6. To exit the System mode, either turn the transmitter power switch off or press the **SCROLL** and **CHANNEL** keys at the same time.

# Accessing the Function Mode

The Travel Adjust feature of the DX3.0 allows the maximum travel of both the steering, throttle and Channel 3 (optional) servos to be increased or decreased in each direction to achieve the exact servo movement needed. The adjustment range is from 0 % to 125%. The travel adjustment is factory set to 100% for both channels. The travel adjustment value displayed on the screen depends on the current position of the steering wheel, trigger, or trim lever to be adjusted. This feature is very useful either to maximize servo travel or to reduce servo over-travel to eliminate servo binding (servo moves further than control mechanism allows), without the need for mechanical linkage adjustment.

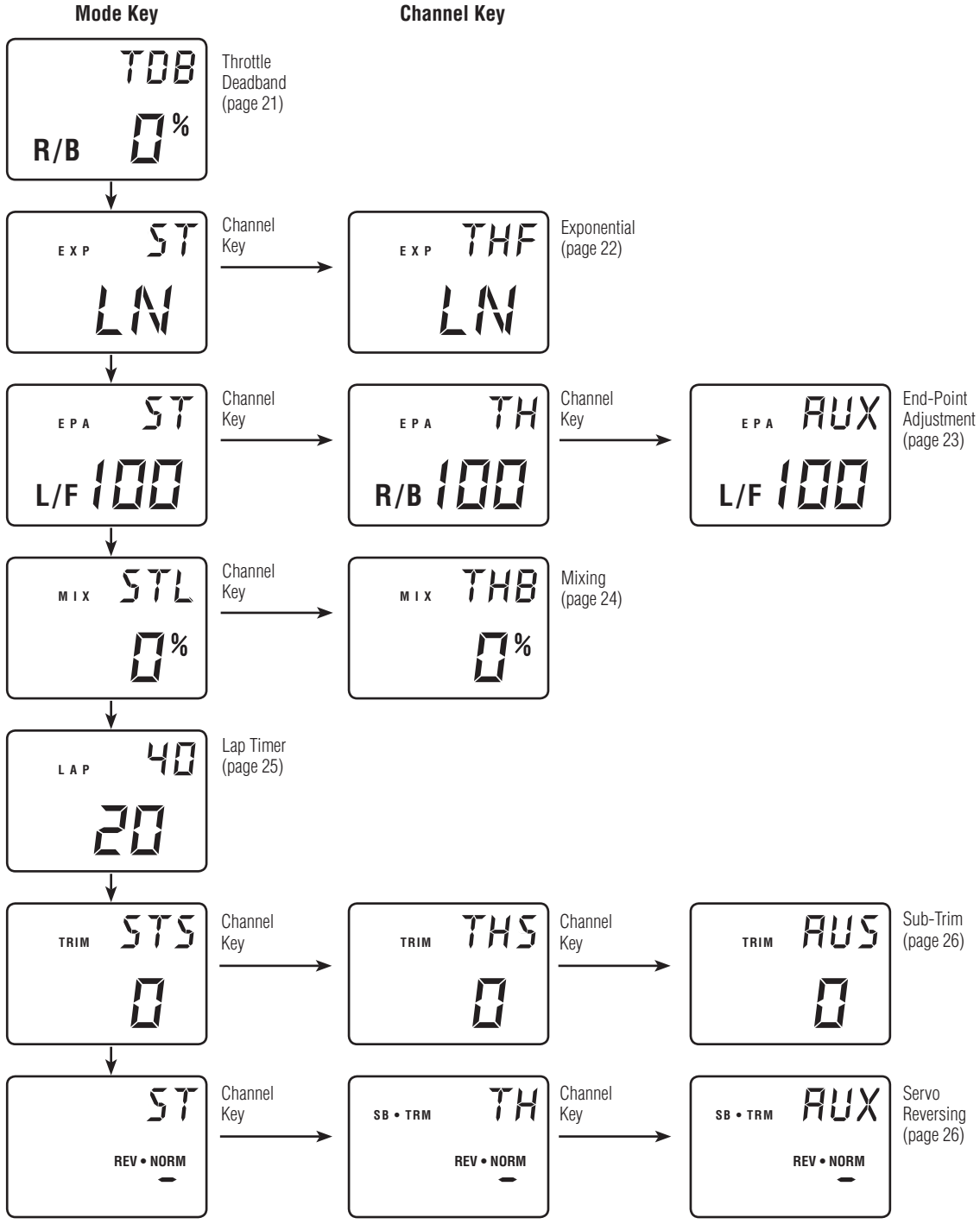

## Throttle Deadband (Function Mode)

The throttle deadband feature is used to reduce/eliminate the dead throttle area that exists at neutral to the starting point of throttle and from neutral to the starting point of braking. This area is sometime known as deadband. As more throttle trim (also known as static brake) is applied, more of the dead trigger area right off neutral exists. To eliminate the throttle deadband, adjust a forward value such that your vehicle's wheels just start to turn when the trigger is slightly squeezed. This provides the most accurate feel and eliminates the dead area in the throttle. To eliminate the braking deadband, adjust the brake value such that your vehicle starts to slow down when the trigger is slightly pushed. This provides the most accurate brake feel and eliminates the dead area when braking.

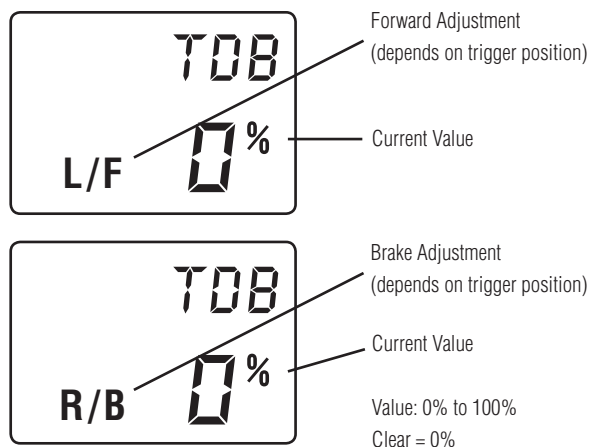

### Accessing the Throttle Deadband Function

1. Turn the transmitter power switch on.
2. Press the **SCROLL** key to access Function mode.
3. Press the **SCROLL** key until "TDB" appears on the screen.
4. Move the trigger accordingly to adjust the forward or braking deadband.
5. Press the **INCREASE** or **DECREASE** key to select the desired value necessary to eliminate dead area.
6. Press the **SCROLL** key to access Exponential mode.
7. To exit the Function mode, either turn the transmitter power switch off or press the **SCROLL** and **CHANNEL** keys at the same time.

## Exponential (Function Mode)

The Exponential feature of the DX3.0 allows you to alter the response rate of the steering or throttle control around neutral without affecting the maximum amount of steering or throttle available. The adjustment range is from -100% to 0% (Linear) to +100%. Exponential is factory set to linear for both steering and throttle. Exponential is often used to settle down a car that is twitchy around center without giving up maximum steering response. The DX3.0 provides both positive (increase sensitivity at neutral) and negative (decrease sensitivity at neutral) exponential values.

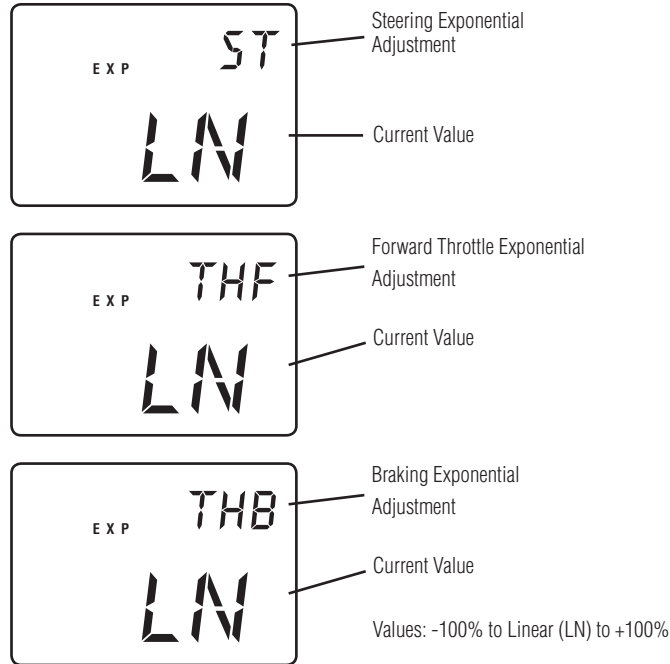

### Accessing the Exponential Function

1. Turn the transmitter power switch on.
2. Press the **SCROLL** key to access Function mode.
3. Press the **SCROLL** key until "EXP" appears on the screen.
4. Press the **INCREASE** or **DECREASE** key to select the desired value necessary exponential value.
5. Press the **SCROLL** key to access the travel End-Point Adjustment function.
6. To exit the Function mode, either turn the transmitter power switch off or press the **SCROLL** and **CHANNEL** keys at the same time.

# End-Point Adjustment (Function Mode)

The End-Point Adjustment feature of the DX3.0 allows the maximum travel of both the steering, throttle and Auxiliary Channel 3 (optional) servos to be increased or decreased in each direction to achieve the exact servo movement needed. The End-Point Adjustment range is from 0% to 125% and is factory set to 100% for both channels. The value displayed on the screen depends on the current position of the steering wheel, trigger, or trim lever to be adjusted. This feature is very useful either to maximize servo travel or to reduce servo over-travel to eliminate servo binding (servo moves further than control mechanism allows), without the need for mechanical linkage adjustment.

The screens below are accessed by turning the wheel to the desired direction to be adjusted (left or right), by moving the trigger to the forward or backward (brake) position, or by moving the Grip Lever A to the forward or back positions.

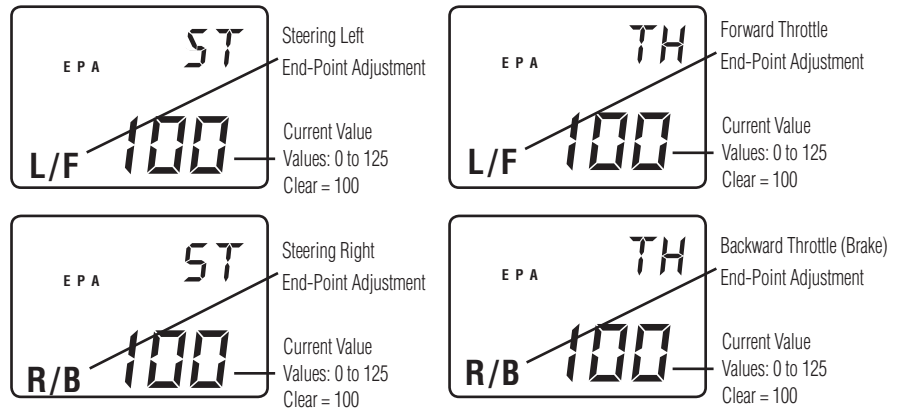

## Channel 3 Screens (optional)

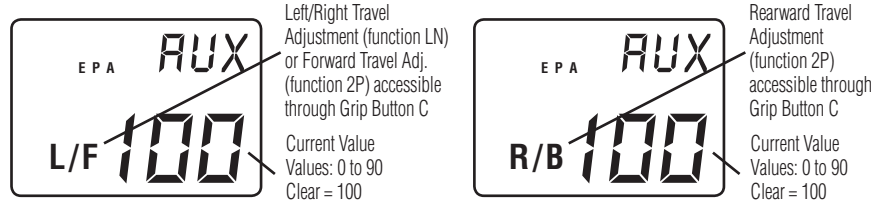

Functions LN & 2P

Functions 2P only

## Accessing the End-Point Adjustment Function

1. Turn the transmitter power switch on.
2. Press the **SCROLL** key to access Function mode.
3. Press the **SCROLL** key until "EPA" appears on the left side of the screen.
4. Press the **CHANNEL** key to select the desired channel to be adjusted.
5. Move the steering wheel, trigger or Grip Button C in the desired direction for adjustment (left/right, forward/reverse or brake). Press the **INCREASE** or **DECREASE** key to achieve the desired amount of travel. Move the wheel, trigger or Grip Button C in the opposite direction to adjust the travel in the opposite direction.

**Note:** For Auxiliary Channel 3 function, if LN is selected, only L/F is adjustable. And if Emergency Steering Button is Eb or LA, Auxiliary Channel 3 defaults to Grip Lever A.

6. Press the **SCROLL** key to access the Mixing Adjustment function.
7. To exit the Function mode, either turn the transmitter power switch off or press the **SCROLL** and **CHANNEL** keys at the same time.

**Note:** When setting the End-Point Adjustment values for the Steering function, it is suggested that, if possible, the maximum travel values be set to an equal value in both directions to maintain proper steering control.

## Programmable Mixing (Function Mode)

The DX3.0 offers two different mixing adjustments that allow for mixing one channel to another channel. The mixes available are Steering-to-Auxiliary Channel Mixing and Throttle-to-Auxiliary Channel Mixing. Each direction is independently adjustable. Popular use of this function includes 4-wheel steering and independent front and rear wheel brakes.

For example, Throttle-to-Auxiliary channel mixing can be used for independent front and rear wheel brakes. Each time the throttle/brakes is moved, the auxiliary channel will move in the direction and to the value input being given by the throttle channel. Mixing is proportional, so small inputs to the throttle will result in small output from the auxiliary channel. The adjustment range is from -125% to 0% to 125%. If the rate is negative, the channel is mixed in the opposite direction.

Both mixes share a single mixing “offset.” The purpose of the mixing offset is to redefine the neutral position of the auxiliary channel, which can be set using Grip Lever A when “LN” is selected in the Auxiliary Channel 3 function. If the “LN” selection is turned off in the Auxiliary Channel 3 function with an offset value currently present, the value will continue to act as a mixing offset until the value is either cleared or changed. If a mix is not required, it is strongly suggested the mixing rate be set for 0%, which is the default.

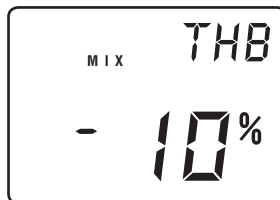

### Accessing the Mixing Adjustment Function

1. Turn the transmitter power switch on.
2. Press the **SCROLL** key to access Function mode.
3. Press the **SCROLL** key until “MIX” appears in the screen.
4. Press the **CHANNEL** key to select the desired mix to be used.
5. Move the steering wheel or trigger in the desired direction for adjustment (left/right, forward/reverse or brake). Press the **INCREASE** or **DECREASE** key to achieve the desired amount of mixing. Move the wheel or trigger in the opposite direction to adjust the mixing in the opposite direction.

**Note:** For Auxiliary Channel 3 function, if LN is selected, only L/F is adjustable.

6. Press the **SCROLL** key to access the Lap Timer (if enabled) or Sub-Trim function.
7. To exit the Function mode, either turn the transmitter power switch off or press the **SCROLL** and **CHANNEL** keys at the same time.



## Lap Timer (Function Mode)

The Lap Timer function of the DX3.0 allows the recording of individual lap times based on a 999 second up-timer. Up to 50 laps and times from 3.0 to 99.9 seconds can be stored in memory for review at a later time. The Lap Timer function will only be enabled and shown in Function mode if Grip Button C (System Mode) is set to "LA." With the Lap Timer enabled, pressing the channel key will alternate between the Normal display screen and Up-Timer display screen.

The Lap Timer is started by pressing Grip Button C. Once active, as shown by the blinking word "LAP," pressing Grip Button C again will begin recording the time of the next lap.

Note: A 3.0 second lap is the quickest lap allowed. This prevents accidental double pushing of Grip Button C when recording lap times. If more than 50 laps are recorded, each new lap will overwrite the oldest lap held in memory.)

To stop the Lap Timer, press the Increase and Decrease keys at the same time. To restart the Lap Timer, press Grip Button C. To reset the Up-Timer, press the Channel key to show the Up-Timer display screen. With the Up-Timer stopped, press the Increase and Decrease keys at the same time to reset.

To review or reset lap times you must be in the Lap Timer function mode screen. Upon entering this function, the screen will always show the last lap time recorded. Use the Increase or Decrease keys to view the desired lap(s).

**Note:** If a recorded lap time is greater than 99.9 seconds, "OVR" will be displayed. To clear all lap times, press the Increase and Decrease keys at the same time.

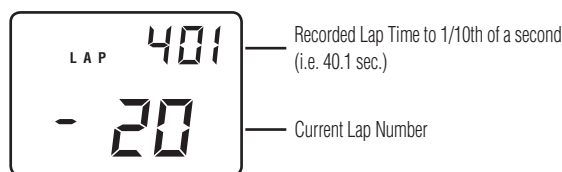

## Accessing the Lap Timer Function

1. Turn the transmitter power switch on.
2. Press the **SCROLL** key to access Function mode.
3. Press the **SCROLL** key until "LAP" appears in the screen.
4. Press the **INCREASE** or **DECREASE** keys to view the desired lap time(s).
5. To reset all lap times, press the **INCREASE** or **DECREASE** keys at the same time.
6. Press the **SCROLL** key to access the Sub-Trim function.
7. To exit the Function mode, either turn the transmitter power switch off or press the **SCROLL** and **CHANNEL** keys at the same time.

## Sub-Trim (Function Mode)

The Sub-Trim function of the DX3.0 is an electronic trimming feature that allows the neutral position of the servo on either the steering, throttle or auxiliary channel (optional) to be moved, while allowing the electronic trim lever for that channel to remain in the center position. This feature is very useful as it allows the servo arm/wheel position to be moved to help with control linkage installation, eliminating the need to make mechanical linkage adjustments.

Although the Sub-Trim function is a very useful feature, it is suggested that only small amounts of sub-trim be used so that no unwanted, non-equal servo travel is created. It is suggested that less than 30 points of Sub-Trim be used during adjustment. If more than 30 points of Sub-Trim are required, it is suggested that a mechanical linkage adjustment be performed.

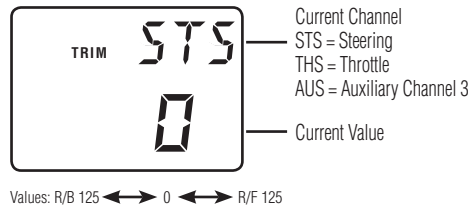

## Accessing the Sub-Trim Function

1. Turn the transmitter power switch on.
2. Press the **SCROLL** key to access Function mode.
3. Press the **SCROLL** key until "TRIM" appears in the screen.
4. Press the **CHANNEL** key to select the desired channel to be adjusted (Steering, Throttle or Auxiliary Channel 3).
5. Press the **INCREASE** or **DECREASE** keys until the proper servo position is achieved.
6. Press the **SCROLL** key to access the Servo Reversing function.
7. To exit the Function mode, either turn the transmitter power switch off or press the **SCROLL** and **CHANNEL** keys at the same time.

## Servo Reversing (Function Mode)

The Servo Reversing feature of the DX3.0 is a very convenient feature when setting up a new model. The purpose of the servo reversing function is to change the direction of the servo rotation in relation to the wheel/trigger movement. The Servo Reversing function is available for the steering, throttle and Auxiliary Channel 3.

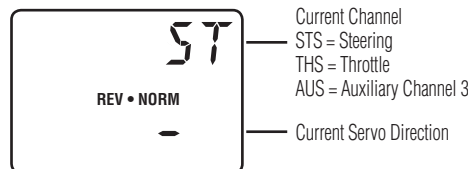

## Accessing the Servo Reversing Function

1. Turn the transmitter power switch on.
2. Press the **SCROLL** key to access Function mode.
3. Press the **SCROLL** key until "REV • NORM" appears in the screen.
4. Press the **CHANNEL** key to select the desired channel to be changed (Steering, Throttle or Auxiliary Channel 3).
5. Press the **INCREASE** or **DECREASE** keys to move the cursor to the desired direction of travel.
6. To exit the Function mode, either turn the transmitter power switch off or press the **SCROLL** and **CHANNEL** keys at the same time.

# Accessing the Direct Trim Mode

The Direct Trim Mode function of the DX3.0 is accessible through the use of the electronic throttle or steering trim levers, as well as the two electronic grip levers (A&B) located on the upper portion of the grip handle. This function allows for quick trim adjustment of these controls.

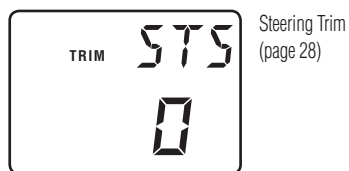

Steering Trim (page 28)

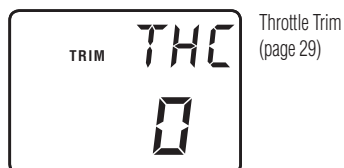

Throttle Trim (page 29)

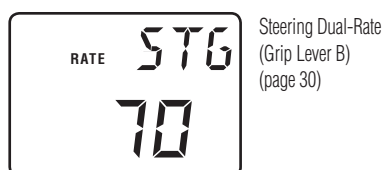

Steering Dual-Rate (Grip Lever B) (page 30)

To access the Direct Trim Mode function, turn the transmitter power switch on. Next, move the desired trim lever to be adjusted. The appropriate screen for the selected trim lever will be displayed. To adjust, simply move the trim lever in the desired direction until the correct amount of trim is achieved. Once the desired trim is achieved, the screen will return to the Normal display screen after approximately two seconds from the last trim input. If the Increase or Decrease keys are pressed any time during the two seconds, the system will return to the previous screen in use.

Only present when Auxiliary function "0" is selected

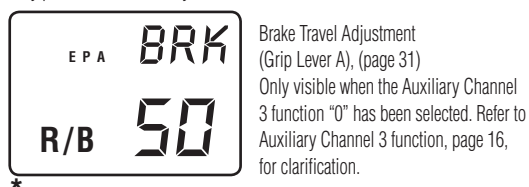

Brake Travel Adjustment (Grip Lever A), (page 31)  
Only visible when the Auxiliary Channel 3 function "0" has been selected. Refer to Auxiliary Channel 3 function, page 16, for clarification.

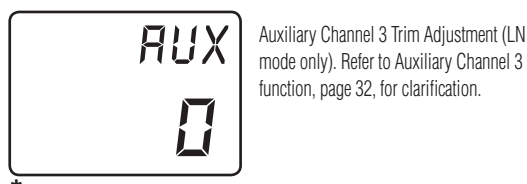

Auxiliary Channel 3 Trim Adjustment (LN mode only). Refer to Auxiliary Channel 3 function, page 32, for clarification.

**\*Note:** When Auxiliary Channel 3 function 2P is selected, the two screens above are not present.

# Steering Trim (STC)

The DX3.0 electronic Steering Trim lever, located just above the steering wheel, allows the center position of the servo to be manipulated in either direction to achieve precise centering of the steering assembly. Steering Travel End-Point Adjustment values (page 23) remain completely independent from the steering trim, unless the trim value exceeds the selected end-point values. (For example: If trim value is set at 30 and end-point values at 15, steering trim will override/alter the end-point value.)

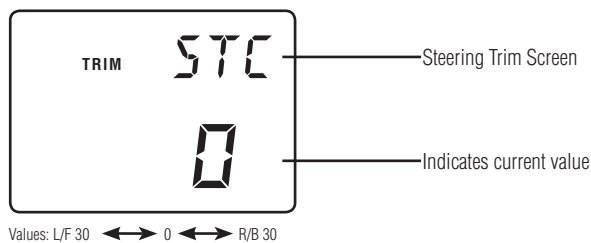

Each click will provide 0.3° of trim to the center of the steering servo with a maximum of 12° allowed.

**Note:** Each click will not always result in a change of the value displayed.

To adjust the steering trim servo position, move the electronic Steering Trim lever either to the left (+) or the right (-). As soon as the trim is moved, the “STC” Steering Trim screen will appear and will continue to be displayed unless the trim lever is untouched for a period of two seconds. To reset the trim value to 0, press the **INCREASE** and **DECREASE** keys at the same time while the “STC” screen is displayed.

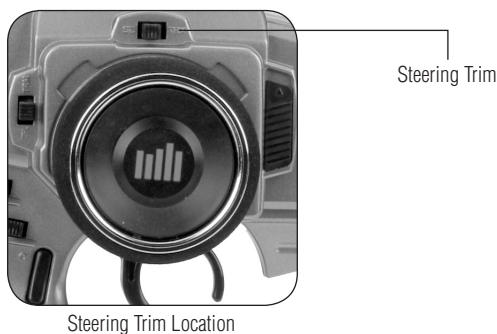

# Throttle Trim (THC)

The DX3.0's electronic Throttle Trim lever, located to the left of the steering wheel, allows the center position of the servo to be manipulated in either direction to achieve precise centering of the throttle trigger neutral position. Throttle End-Point adjustment values (page 23) remain completely independent from the throttle trim, unless the trim value exceeds the selected end-point values. (For example: If the trim value is set at 40 and the end-point values at 30, Throttle Trim will override/alter the end-point value.)

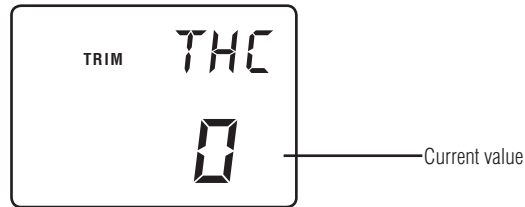

Values: L/F 60 ↔ 0 ↔ R/B 60

Each click will provide 0.3° of trim to the throttle servo with a maximum of 24° allowed.

**Note:** Each click will not always result in a change of the value displayed.

To adjust the Throttle Trim servo position, move the electronic steering trim lever either up (+) or down (-). As soon as the trim is moved, the "THC" Throttle Trim screen will appear and will continue to be displayed unless the trim lever is untouched for a period of two seconds. To reset the trim value to zero, press the **INCREASE** and **DECREASE** keys at the same time while the "THC" screen is displayed.

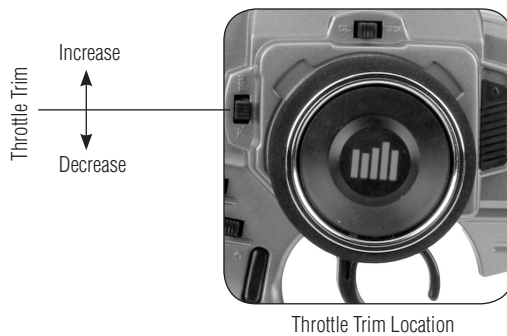

# Grip Lever B: Steering Dual Rate Trim Adjustment STG

The Steering Dual Rate Trim Adjustment, located at Grip Lever B, allows the dual rate value (maximum servo travel) to be increased or decreased within a range from 100% through 20% of the total end-point value established in the steering EPA function. This function is very useful in race conditions as it allows you to custom tailor the steering radius and sensitivity for the current track conditions. Please note that since the Dual Rate value shown in the “STG” screen is the percentage of the end-point value established in the steering EPA function, the value will not always increase or decrease each time the Grip Lever B is moved.

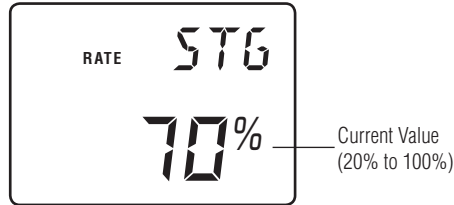

If the Emergency Steering button function (page 17) is active, pressing Grip Button C will restore the steering dual rate to 100% until the button is released.

To adjust the Steering Dual Rate value, move the electronic Grip Lever B either left (-) or right (+). As soon as the trim is moved, the “STG” Steering Dual Rate screen will appear and will continue to be displayed unless the Grip Lever B is untouched for a period of two seconds. To reset the trim value to the factory preset setting of 70%, press the INCREASE and DECREASE keys at the same time while the “STG” screen is displayed.

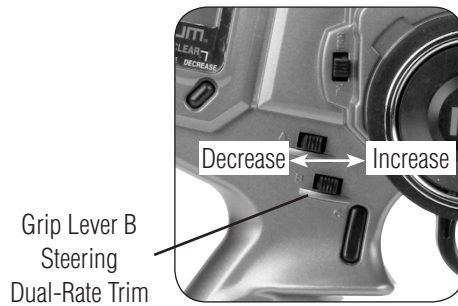

# Grip Lever A: BrakeEnd-Point Adjustment BRK/Auxiliary Channel 3 Access

The Brake End-Point Adjustment, located at Grip Lever A, allows the maximum servo travel on the braking side of the throttle trigger to be increased or decreased from 100% to 0% (off). This function is very useful in race conditions as it allows the racer to custom tailor the “panic” brake value to maximize the car’s braking power for the current track conditions. Please note that since the brake end-point value shown in the “BRK” screen is a percentage of the total braking value established in the End-Point Adjustment function (page 23), the value will not always increase or decrease each time the Grip Lever A is moved.

**Note:** If Grip Lever A is assigned an Auxiliary Channel 3 function by selecting “LN” or “2P” with Grip Button C in use, the Brake End-Point Adjustment will not be available.

To adjust the brake end-point value, move the electronic Grip Lever A either left (–) or right (+). As soon as the grip lever is moved, the BRK End-Point Adjustment screen will appear and will continue to be displayed unless the Grip Lever A is untouched for a period of two seconds.

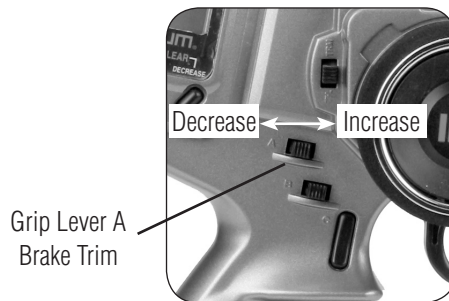
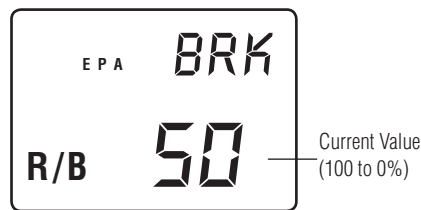

Move the grip lever A to the left or right to decrease or increase values.

## Auxiliary Channel 3 Access (Fuel Mixture)

When selected, Grip Lever A can be used to access the Auxiliary Channel 3 function of the DX3.0 for use as a fuel mixture channel.

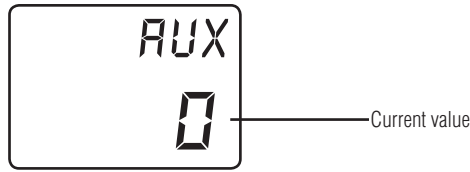

When the LN (linear) Auxiliary Channel 3 function is selected, Grip Lever A can be used to change the neutral position of the servo to lean or richen the engine's fuel mixture. Once the desired fuel mixture has been achieved, the Grip Lever A value indicated on this screen can be transferred manually to the Sub-Trim function (page 26) and the value of the AUX screen can be returned to zero. Please refer to the diagram below for proper grip lever operation.

## Auxiliary Channel 3 (Transmission Shift Selector)

When the 2P Auxiliary Channel function is selected, the Grip Lever A can be used to move the Auxiliary 3 Channel servo to one of two positions (left/right or forward/reverse) when LA or Eb is selected for the Grip Button C function. Please refer to diagram A below for proper shifting procedures.

**Note:** The End-Point Adjustment function (page 23) is used to set the forward and reverse gear servo travel positions.

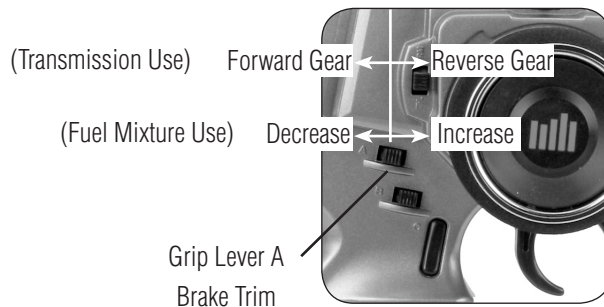



# DX3.0 Data Sheet

## SYSTEM MODE

MODEL NUMBER	1	2	3	4
MODEL NAME				
AUX FUNCTION	0 /2P/ LN			
GRIP BUTTON C	0 /Eb/ LA			

## FUNCTION MODE

	STEERING	THROTTLE	AUXILIARY
THROTTLE DEADBAND	/	F _____% B _____%	/
EXPONENTIAL	_____ %	F _____% B _____%	/
END-POINT ADJ.	L _____ R _____	F _____ B _____	L _____ R _____
MIXING	L _____% R _____%	F _____% B _____%	/
SUB-TRIM			
SERVO REVERSING	REV•NORM	REV•NORM	REV•NORM

## DIRECT MODE

TRIM VALUES	STEERING -/+	THROTTLE -/+	AUX CHANNEL 3 -/+
GRIP LEVER B STEERING D/R	_____ %	/	/
GRIP LEVER A VALUES	/	BRAKE EPA	AUX FUNCTION "LN"
		_____ %	

# DX3.0 Data Sheet

## SYSTEM MODE

MODEL NUMBER	1	2	3	4
MODEL NAME				
AUX FUNCTION	0 /2P/ LN			
GRIP BUTTON C	0 /Eb/ LA			

## FUNCTION MODE

	STEERING	THROTTLE	AUXILIARY
THROTTLE DEADBAND	/	F _____% B _____%	/
EXPONENTIAL	_____ %	F _____% B _____%	/
END-POINT ADJ.	L _____ R _____	F _____ B _____	L _____ R _____
MIXING	L _____% R _____%	F _____% B _____%	/
SUB-TRIM			
SERVO REVERSING	REV•NORM	REV•NORM	REV•NORM

## DIRECT MODE

TRIM VALUES	STEERING -/+	THROTTLE -/+	AUX CHANNEL 3 -/+
GRIP LEVER B STEERING D/R	_____ %	/	/
GRIP LEVER A VALUES	/	BRAKE EPA	AUX FUNCTION "LN"
		_____ %	

# DX3.0 Data Sheet

## SYSTEM MODE

MODEL NUMBER	1	2	3	4
MODEL NAME				
AUX FUNCTION	0 /2P/ LN			
GRIP BUTTON C	0 /Eb/ LA			

## FUNCTION MODE

	STEERING	THROTTLE	AUXILIARY
THROTTLE DEADBAND	/	F _____% B _____%	/
EXPONENTIAL	_____ %	F _____% B _____%	/
END-POINT ADJ.	L _____ R _____	F _____ B _____	L _____ R _____
MIXING	L _____% R _____%	F _____% B _____%	/
SUB-TRIM			
SERVO REVERSING	REV•NORM	REV•NORM	REV•NORM

## DIRECT MODE

TRIM VALUES	STEERING -/+	THROTTLE -/+	AUX CHANNEL 3 -/+
GRIP LEVER B STEERING D/R	_____ %	/	/
GRIP LEVER A VALUES	/	BRAKE EPA	AUX FUNCTION "LN"
		_____ %	

# DX3.0 Data Sheet

## SYSTEM MODE

MODEL NUMBER	1	2	3	4
MODEL NAME				
AUX FUNCTION	0 /2P/ LN			
GRIP BUTTON C	0 /Eb/ LA			

## FUNCTION MODE

	STEERING	THROTTLE	AUXILIARY
THROTTLE DEADBAND	/	F _____% B _____%	/
EXPONENTIAL	_____ %	F _____% B _____%	/
END-POINT ADJ.	L _____ R _____	F _____ B _____	L _____ R _____
MIXING	L _____% R _____%	F _____% B _____%	/
SUB-TRIM			
SERVO REVERSING	REV•NORM	REV•NORM	REV•NORM

## DIRECT MODE

TRIM VALUES	STEERING -/+	THROTTLE -/+	AUX CHANNEL 3 -/+
GRIP LEVER B STEERING D/R	_____ %	/	/
GRIP LEVER A VALUES	/	BRAKE EPA	AUX FUNCTION "LN"
		_____ %	

# DX3.0 Data Sheet

## SYSTEM MODE

MODEL NUMBER	1	2	3	4
MODEL NAME				
AUX FUNCTION	0 /2P/ LN			
GRIP BUTTON C	0 /Eb/ LA			

## FUNCTION MODE

	STEERING	THROTTLE	AUXILIARY
THROTTLE DEADBAND	/	F _____% B _____%	/
EXPONENTIAL	_____ %	F _____% B _____%	/
END-POINT ADJ.	L _____ R _____	F _____ B _____	L _____ R _____
MIXING	L _____% R _____%	F _____% B _____%	/
SUB-TRIM			
SERVO REVERSING	REV•NORM	REV•NORM	REV•NORM

## DIRECT MODE

TRIM VALUES	STEERING -/+	THROTTLE -/+	AUX CHANNEL 3 -/+
GRIP LEVER B STEERING D/R	_____ %	/	/
GRIP LEVER A VALUES	/	BRAKE EPA	AUX FUNCTION "LN"
		_____ %	

# Warranty and Service Information

## Spektrum® 1-Year Limited Warranty Period

Horizon Hobby, Inc. guarantees this product to be free from defects in both material and workmanship for a period of 1 year from the date of purchase.

### Limited Warranty & Limits of Liability

Pursuant to this Limited Warranty, Horizon Hobby, Inc. will, at its option, (i) repair or (ii) replace, any product determined by Horizon Hobby, Inc. to be defective. In the event of a defect, these are your exclusive remedies.

This warranty does not cover cosmetic damage or damage due to acts of God, accident, misuse, abuse, negligence, commercial use, or modification of or to any part of the product. This warranty does not cover damage due to improper installation, operation, maintenance, or attempted repair by anyone other than an authorized Horizon Hobby, Inc. service center. This warranty is limited to the original purchaser and is not transferable. In no case shall Horizon Hobby's liability exceed the original cost of the purchased product and will not cover consequential, incidental or collateral damage. Horizon Hobby, Inc. reserves the right to inspect any and all equipment involved in a warranty claim. Repair or replacement decisions are at the sole discretion of Horizon Hobby, Inc. Further, Horizon Hobby reserves the right to change or modify this warranty without notice. REPAIR OR REPLACEMENT AS PROVIDED UNDER THIS WARRANTY IS THE EXCLUSIVE REMEDY OF THE CONSUMER. HORIZON HOBBY, INC. SHALL NOT BE LIABLE FOR ANY INCIDENTAL OR CONSEQUENTIAL DAMAGES. As Horizon Hobby, Inc. has no control over use, setup, final assembly, modification or misuse, no liability shall be assumed nor accepted for any resulting damage or injury. By the act of use, setup or assembly, the user accepts all resulting liability. If you as the purchaser or user are not prepared to accept the liability associated with the use of this product, you are advised to return this product immediately in new and unused condition to the place of purchase.

### Safety Precautions

This is a sophisticated hobby product and not a toy. It must be operated with caution and common sense and requires some basic mechanical ability. Failure to operate this product in a safe and responsible manner could result in injury or damage to the product or other property. This product is not intended for use by children without direct adult supervision. The product manual contains instructions for safety, operation and maintenance. It is essential to read and follow all the instructions and warnings in the manual, prior to assembly, setup or use, in order to operate correctly and avoid damage or injury.

### Questions, Assistance, and Repairs

Your local hobby store and/or place of purchase cannot provide warranty support or repair. Once assembly, setup or use of the product has been started, you must contact Horizon Hobby, Inc. directly. This will enable Horizon to better answer your questions and service you in the event that you may need any assistance.

### Questions or Assistance

For questions or assistance, please direct your email to [productsupport@horizonhobby.com](mailto:productsupport@horizonhobby.com), or call 877.504.0233 toll free to speak to a service technician.

### Inspection or Repairs

If your product needs to be inspected or repaired, please call for a Return Merchandise Authorization (RMA). Pack the product securely using a shipping carton. Please note that original boxes may be included, but are not designed to withstand the rigors of shipping without additional protection. Ship via a carrier that provides tracking and insurance for lost or damaged parcels, as Horizon Hobby, Inc. is not responsible for merchandise until it arrives and is accepted at our facility. Include your complete name, address, phone number where you can be reached during business days, RMA number, and a brief summary of the problem. Be sure your name, address, and RMA number are clearly written on the shipping carton.

### Warranty Inspection and Repairs

To receive warranty service, you must include your original sales receipt verifying the proof-of-purchase date. Provided warranty conditions have been met, your product will be repaired or replaced free of charge. Repair or replacement decisions are at the sole discretion of Horizon Hobby.

### Non-Warranty Repairs

Should your repair not be covered by warranty and the expense exceeds 50% of the retail purchase cost, you will be provided with an estimate advising you of your options. You will be billed for any return freight for non-warranty repairs. Please advise us of your preferred method of payment. Horizon Hobby accepts money orders and cashiers checks, as well as Visa, MasterCard, American Express, and Discover cards. If you choose to pay by credit card, please include your credit card number and expiration date. Any repair left unpaid or unclaimed after 90 days will be considered abandoned and will be disposed of accordingly.

Electronics and engines requiring inspection or repair should be shipped to the following address (freight prepaid):

Horizon Service Center  
ATTN: Spektrum Service  
4105 Fieldstone Road  
Champaign, IL 61822

Include your complete name and address information inside the carton and clearly write it on the outer label/return address area. Include a brief summary of the problem. Date your correspondence and be sure that your name and address appear on this enclosure. To receive warranty service, you must include your original sales receipt verifying the proof-of-purchase date. Providing warranty conditions have been met, your equipment will be repaired at no charge or replaced at the discretion of Horizon Hobby.

# FCC Information

This device complies with part 15 of the FCC rules. Operation is subject to the following two conditions: (1) This device may not cause harmful interference, and (2) this device must accept any interference received, including interference that may cause undesired operation.

**Caution:** Changes or modifications not expressly approved by the party responsible for compliance could void the user's authority to operate the equipment.

This product contains a radio transmitter with wireless technology which has been tested and found to be compliant with the applicable regulations governing a radio transmitter in the 2.400GHz to 2.4835GHz frequency range.

The associated regulatory agencies of the following countries recognize the noted certifications for this product as authorized for sale and use:

USA	Canada	Belgium
Denmark	France	Finland
Germany	Italy	Netherlands
Spain	Sweden	UK

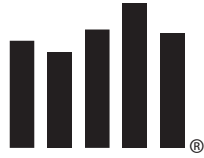

**SPEKTRUM®**

**HORIZON**  
H O B B Y

© 2006 Horizon Hobby, Inc.  
4105 Fieldstone Road  
Champaign, Illinois 61822  
(877) 504-0233  
**horizonhobby.com**