

SPEKTRUM[®]

2-Channel, 2-Model Memory DSM Racing System



Table of Contents

Alternate Languages.....	2
Introduction.....	3
DX2.0 Quick Start Setup.....	3
DX2.0 with Digital Spectrum Modulation	5
Binding	6
Antenna.....	7
Direct Trim Access	8
Control Identification and Location	9
System Features.....	10
R/C Safety Precautions.....	10
Steering Tension Adjustment.....	10
Receiver Connections and Installation.....	11
Servo Layout.....	12
Charging Jack.....	12
Key Input and Display	12
Display Screens	13
Accessing the System Mode	14
Model Select (System Mode).....	15
Model Name Entry (System Mode)	16
Grip Button C Function Select.....	16
Data Reset (System Mode).....	17
Accessing the Function Mode	18
End-Point Adjustment (Function Mode).....	19
Sub-Trim (Function Mode).....	20
Servo Reversing (Function Mode).....	21
Accessing the Direct Trim Mode.....	22
Steering Trim (STC)	23
Throttle Trim (THC)	24
Grip Lever B: Steering Dual Rate Trim Adjustment STG.....	25
Grip Lever A: Brake Endpoint Adjustment BRK Brake Endpoint Adjustment	26
DX2.0 Data Sheet	27
Warranty and Service Information	29
FCC Information.....	30

Alternate Languages

ITALIAN: Per la versione italiana di questo manuale vi preghiamo di visitare il sito www.spektrumrc.com

FRENCH: Pour consulter ce manuel en français, visiter le site www.spektrumrc.com

GERMAN: Zur Ansicht der Bedienungsanleitung in den Deutsch besuchen Sie bitte www.spektrumrc.com

SPANISH: Para ver este manual en Español entra en www.spektrumrc.com

Introduction

Thank you for purchasing Spectrum's DX2.0 radio system. The DX2.0 is designed to provide R/C racers with a bulletproof 2.4GHz spread spectrum radio link. With the DX2.0 DSM system you'll no longer have to wait for a frequency clip, worry about radio interference from noisy motors or ESCs or be concerned that someone may turn on a radio on your channel causing interference. In addition, the DX2.0's programming is user-friendly and offers the most important features and functions that racers demand. It's important that you carefully read this manual before attempting to operate your DX2.0 system. For your convenience, a blank data sheet has been included in the back of this manual. Once you have input all the necessary data for a particular model, we recommend that you write that information down on the data sheet provided. This insures that, in the rare case of a memory failure, you will not lose your models' setup data.

For those who would like to get out to the track quickly with just the basic radio setup, please refer to the Quick Start section that follows.

DX2.0 Quick Start Setup

Included in this manual are in-depth instructions detailing all the steps and procedures needed to correctly program each of the DX2.0's features. Quick Start covers the basic programming information necessary to get you to the fast track. Later, when you want to learn more about the specific features of the DX2.0, refer to the appropriate page(s) in this manual for more detailed programming information.

Binding

It's necessary to program the receiver to a specific transmitter so that the receiver will only recognize that transmitter, ignoring signals from any other sources. If the receiver is not bound to a transmitter, the system will not operate. Also, during the binding process, the servo fail-safe positions are set.

1. Make sure the transmitter and receiver are turned off.
2. With the receiver off, press and hold the bind button on the receiver while turning on the receiver.
3. Release the bind button when the LED flashes green.
4. With the transmitter off, place the transmitter steering wheel and the throttle trigger in their desired fail-safe positions (normally brake and straight ahead steering).
5. Press and hold the bind button on the transmitter while turning on the transmitter.
6. Release the bind button after the green LED flashes.

After several seconds, the LED on the receiver and the LED on the transmitter will quit flashing and remain solid, indicating that the binding process was successful. Once binding is complete, the system will automatically connect.

Note: See page 6 for a detailed description of the binding process.

DX2.0 Quick Start Setup (continued)

Servo Reversing

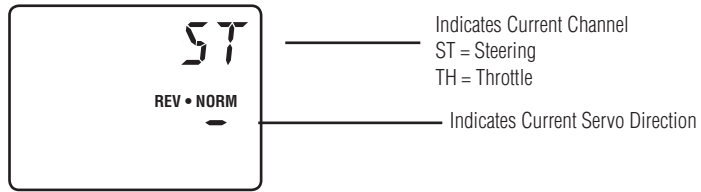

1. With the transmitter power switch on, press the **SCROLL** key to enter the Function mode.
2. Press the **SCROLL** key until "REV.NORM" appears on the screen. The "ST" indicates the steering servo reversing screen.
3. Press the **INCREASE** or **DECREASE** key to move the cursor to the desired servo direction (REV.NORM).
4. Press the **CHANNEL** key once to access the throttle servo reversing screen.
5. To select the direction of the throttle servo, repeat Step 3 above.



End-Point (Travel) Adjustment

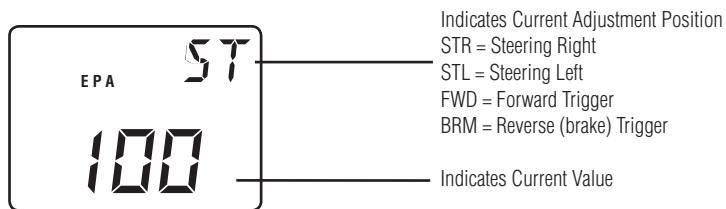

1. From the Servo Reverse function, press the **SCROLL** key once to access the End-Point (Travel) Adjustment function (the EPA screen with "ST" will appear).

Steering Adjustment

2. Rotate the steering wheel in the desired direction (left or right) to be adjusted.
3. Press the **INCREASE** or **DECREASE** keys to select the desired travel value.

Throttle Adjustment

4. Press the **CHANNEL** key once. TH will appear on the screen.
5. Pull the trigger for forward or push the trigger for brake adjustment.
6. Press the **INCREASE** or **DECREASE** keys to select the desired travel value.

DX2.0 with Digital Spectrum Modulation

The DSM® system operates in the 2.4GHz band (that's 2400MHz). This high frequency offers a significant advantage as it's well out of the range of model-generated radio interference (like motor and ESC noise). All the complex issues that now exist using 27 and 75MHz radios with model-generated interfering noise are eliminated with this system. The DSM system uses Direct Sequencing Spread Spectrum modulation to generate a wide signal on a single frequency. The FCC requires that these systems be "smart"—incorporating collision avoidance such that when a system is turned on, it scans the 2.4GHz band and selects a channel that is not being used, then begins transmitting on that unused channel. 79 channels are available and the odds of one DSS spread spectrum system interfering with another are astronomically remote. The 2.4GHz spectrum has a capacity of 79 channels. In the unlikely event that the spectrum is full, the 80th system will not connect or cause any interference going into hold scan until a channel is free.

Binding

During the first installation, the receiver(s) must be bound to the transmitter. Binding is necessary to program the receiver(s) to distinguish its corresponding transmitter from others. Also fail-safe positions are transferred from the transmitter to the receiver during binding. See binding below for more details.

It is necessary to bind the receiver to the transmitter during the first installation, and is recommended when the receiver is moved from one vehicle to another. Receivers can be re-bound to the same transmitter or to other transmitters an infinite number of times. Also multiple receivers can be bound to a single transmitter, common when using one transmitter to operate several models.

Only bound receivers and transmitters can connect. During power-up, the transmitter scans for a free channel while the receiver scans for its bound transmitter. During the scanning process, LEDs on both the transmitter and receiver flash rapidly. When control is achieved, the LED remains on continuously.

In the unlikely event that the link is lost during use, the receiver will drive the servos to their fail-safe positions that were preset during the binding process. If the receiver is turned on prior to turning on the transmitter, the receiver will enter the fail-safe mode, driving the servos to their preset fail-safe position. When the transmitter is turned on, normal control is resumed.

To bind the receiver to the transmitter

1. Make sure the transmitter and receiver are turned off

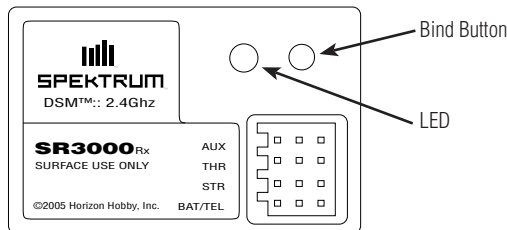

Binding (continued)

2. With the receiver off, press and hold the bind button on the receiver while turning on the receiver.
3. Release the bind button when the LED flashes green.
4. With the transmitter off, place the transmitter steering wheel and throttle trigger channels in their desired fail-safe positions (normally brake and straight-ahead steering).

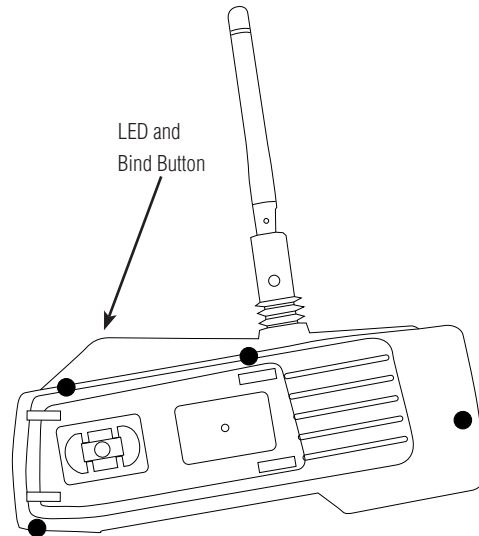

5. Press and hold the bind button on the transmitter while turning on the transmitter.
6. Release the bind button after the green LED flashes.

After several seconds the LED on the receiver and the LED on the transmitter will quit flashing and remain solid, indicating that the binding process was successful. Once binding is complete, the system will automatically connect.

Antenna

At 8.5 inches in length, the receiver antenna is significantly shorter than conventional antennas. The receiver has provisions that allow the antenna to exit the top of the receiver or at the end of the receiver. To switch antenna positions, it is necessary to open the case to change the antenna exit position. Like all antennas, it's important to mount the antenna vertically. In most cases the antenna can be mounted inside the body with no loss of range. Mount the receiver antenna as recommended by the manufacturer of the vehicle, however, it may be necessary to trim the plastic antenna tube (included with your vehicle) to allow the antenna to extend at least 1/2" past the tip of the tube.

Note: If desired, the antenna can be shortened (cut) to exactly 3.6" with negligible loss of range, and in some applications the short 3.6" length will make installation easier.

Direct Trim Access

Steering and Throttle Trim Adjustment

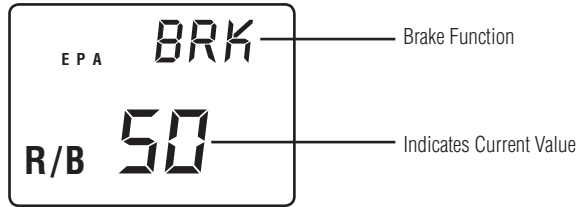
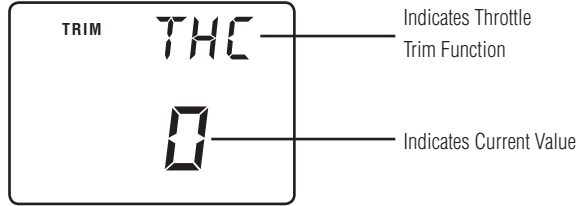
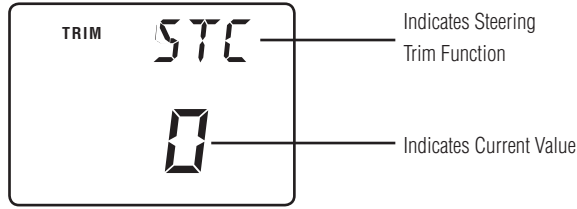

Steering Servo Trim Adjustment:

1. With the transmitter power switch on, move the digital steering trim lever in the desired position to be adjusted. The steering trim value screen will appear automatically.

Throttle Servo Trim Adjustment:

2. With the transmitter power switch on, move the digital throttle trim lever in the desired position to be adjusted. The throttle trim value screen will appear automatically.



Control Identification and Location



* To remove the Battery Cover, press down where it says "press" and push the cover in the direction of the arrow. Remove the battery cover and install 8 "AA" batteries in the direction as molded into the battery case. If the transmitter voltage fails to register, check for correct battery installation and review voltage again.

System Features

- DSM 2.4GHz Spread Spectrum Modulation
- Two channels
- Easy-to-read LCD graphics display
- Two-model memory
- Three-character model name entry
- Electronic digital trim levers for throttle and steering
- Two assignable electronic grip levers
- Direct display trim function
- Sub-trim
- Steering rate adjustment
- Independent steering endpoint adjustments
- Brake/throttle endpoint adjustment
- Low battery alarm
- Charge jack receptacle (rechargeable batteries not included; order JRPB958)

R/C Safety Precautions

For safe and reliable performance of your R/C model, please carefully read and follow these guidelines:

1. Radio control models are not toys. They are capable of inflicting serious injury to people and property. Use caution at all times when operating your model.
2. You are responsible for the safe operation of your R/C model. You must properly install, test and operate your model with a clear sense of that responsibility. Do not take risks that might endanger yourself or others.
3. Running an R/C car in the streets is very dangerous to both drivers and models. Avoid running your model in areas occupied by full-size automobiles. To locate areas where you can safely operate your model, you should contact your local hobby shop for R/C tracks or clubs in your area.
4. When running an R/C boat, keep it away from any swimmers, full-size boats, or wildlife. Also, watch carefully for fishing lines that can get tangled in the propeller.
5. If at any time while operating your RC model you sense abnormal model functioning, end your operation immediately. Do not operate your model again until you are certain the problem has been corrected.

CAUTION: Control of your model is impossible without sufficient voltage for the transmitter and receiver. A weak transmitter battery will decrease your range of operation and a weak receiver battery will slow servo movement and decrease your range of operation. Check your receiver pack voltage often to avoid losing control of your model.

Steering Tension Adjustment

Steering tension is adjustable via the recessed screw located beneath the steering wheel (see page 9 for exact location). Turning the screw clockwise increases the steering tension.

Receiver Connections and Installation

Note: When using a separate Ni-Cd receiver as a power source, the operating voltage range is 4.8–6.0V (4–5 cells) under load.

Attention: Make sure the male and female connectors have the correct polarity (+/–) before connecting. Be sure to orient the servo plug correctly for proper insertion.

Most electronic speed controllers are set up for B.E.C. (Battery Elimination Circuitry) operation and plug directly into your receiver. See Figure A for a typical setup and check your speed controller’s manual for correct installation.

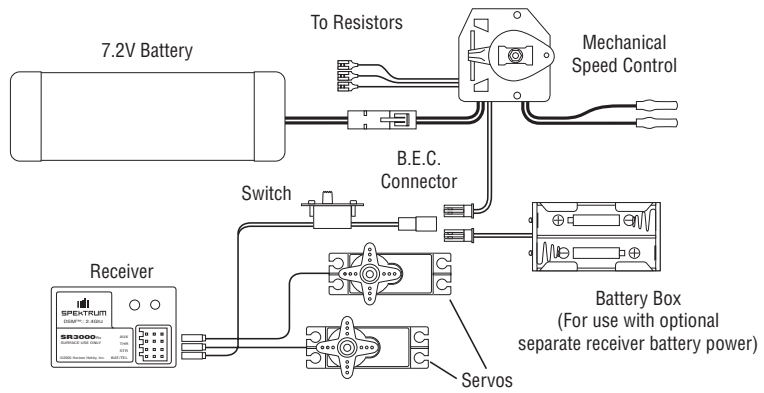

Figure A – Connections to B.E.C. and receiver with mechanical speed controller. Ni-Cd battery and speed controller are not included in the radio set.

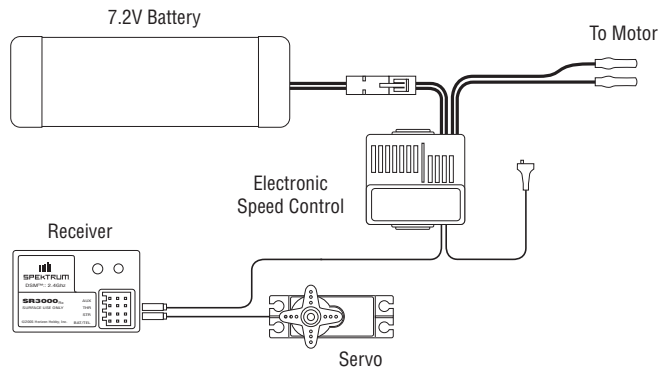
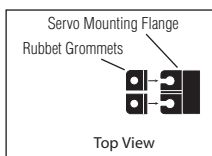
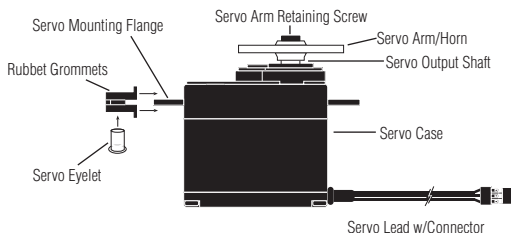

Figure B – Connections to B.E.C. and receiver with electronic speed controller. Ni-Cd battery and speed controller are not included in the radio set.

Servo Layout

Note: Rubber grommets (and sometimes eyelets) are used in fuel-powered vehicles.



Charging Jack

Located on the left-hand side of the transmitter is the charging jack, which accepts only JR® or Spektrum® style wall chargers. Please do not attempt to use any other brand of wall charger as it may be reverse polarity and can cause damage to your system. Only use the JR or Spektrum type wall charger when the DX2.0 is equipped with Ni-Cd batteries (available separately, JRPB958).

Spektrum Transmitter Charge Jack Polarity:



Charger Pigtail For Transmitter

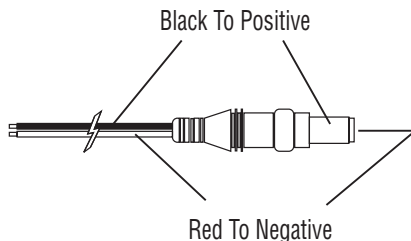

Key Input and Display

Key	Use
SCROLL	Used to move up through the available functions
CHANNEL	Used to select the desired channel
INCREASE	Used to increase the value of the selected function
DECREASE	Used to decrease the value of the selected function

To enter the System Mode press the **SCROLL** and **CHANNEL** keys simultaneously and hold while turning on the transmitter.



To enter the Function Mode, press the **SCROLL** key while the transmitter is on.

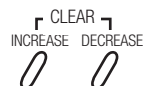

Press the **INCREASE** and **DECREASE** keys simultaneously to clear the screen or return to factory preset.

Display Screens

Normal Display Screen

When the power switch is turned on, the LCD screen will read as shown below. This screen is referred to as the Normal Display.

Note: If any of the electronic trim buttons are moved while in this screen, the screen will automatically change to display the trim in use. This is called the Direct Trim Mode. For more information on the feature, please see page 8 of this manual.

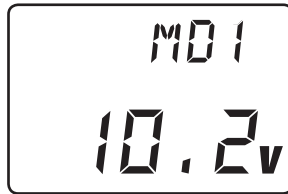

Low Battery Screen/Lithium Battery Backup

When the voltage of the eight "AA" batteries drops below 9.0 volts, the DX2.0's display screen will alternate between the Normal (see above) and Low Battery screen (BAT), and a continuous beeping will occur, indicating that the batteries need to be replaced before further use. The Low Battery screen is active during any operating modes.



Lithium Battery

Your DX2.0 radio system is equipped with a five-year lithium battery backup system. This system is designed to protect and retain all radio programming in the event that the transmitter batteries drop below the required 9.0 volts, or the transmitter battery case is removed during battery changes. If after five years it becomes necessary to replace the lithium battery, return your system to the Horizon Service Center for repair (see address, page 29).

Memory Backup Screen

If the Memory Backup screen appears, this indicates the possibility of a ROM problem or the lithium battery is dead. If you switch the power off and on again, and the transmitter is in the default mode with all data lost, it is strongly suggested that the DX2.0 transmitter be returned to the Horizon Service Center for servicing (see Warranty Information, page 29).



Accessing the System Mode

To enter the System Mode, press both the **SCROLL** and **CHANNEL** keys at the same time while turning on the transmitter power switch. By pressing the **SCROLL** key, you can now choose Model Select, Model Name Input, Grip Button C function or the Data Reset function as shown here on the System Mode flow chart. Information for each function is located on the page number listed next to the function name on the flow chart.

To exit the System Mode, press the **SCROLL** and **CHANNEL** keys at the same time, or simply turn off the transmitter.

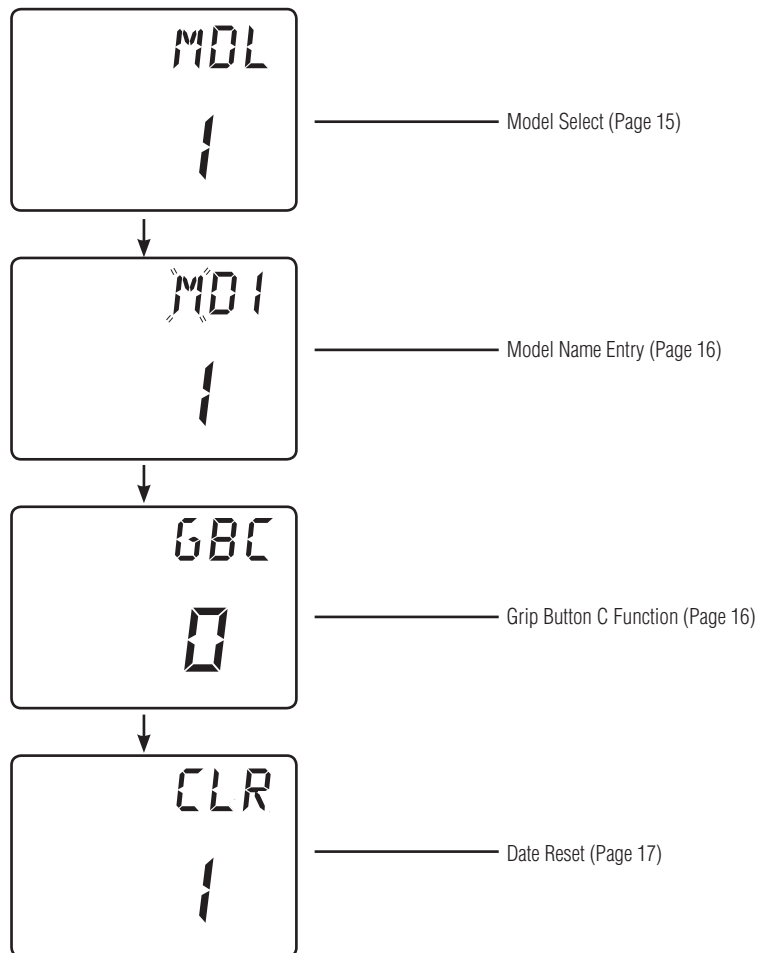

Model Select (System Mode)

The DX2.0 has memory for two models. This feature allows for two different models to be operated with the same transmitter (additional receivers and servos must be purchased separately) or one model with two different race setups.

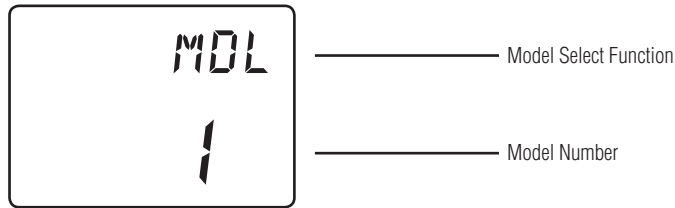

Accessing the Model Select Function

1. Press the **SCROLL** and **CHANNEL** keys at the same time and hold.
2. Turn the transmitter power switch on to enter System Mode.
3. If "MDL" does not appear on the screen, press the SCROLL key until MDL appears.
4. Press the **INCREASE** or **DECREASE** keys to select the desired model number (1 or 2).
5. Press the **SCROLL** key to access the Model Name Entry Function.
6. To exit the System Mode, either turn the transmitter power switch off or press the **SCROLL** and **CHANNEL** keys at the same time.

Model Name Entry (System Mode)

The DX2.0 allows a three-character name to be input for each of the two (2) models available. The current model, with name, will then be displayed in the Normal display screen. This feature is useful to help identify different models, setups, etc. For information on selecting models 1 or 2, please refer to the Model Select Function (page 15).

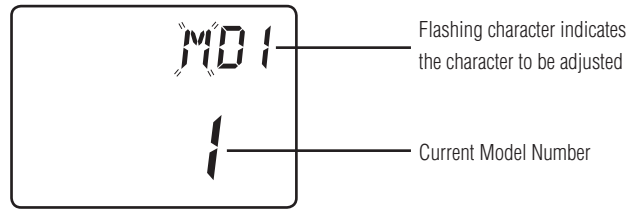

Accessing the Model Name Entry Function

To access the Model Name Entry function, follow the steps below:

1. Press the **SCROLL** and **CHANNEL** keys at the same time and hold.
2. Turn on the transmitter power switch to enter the System Mode.
3. Press the **SCROLL** key until "MD1" appears on the screen with the first character flashing.
4. Press the **INCREASE** or **DECREASE** keys to select the correct letter/number for the first character (flashing).
5. To change the remaining two characters, press the **CHANNEL** key until the desired character to be changed is flashing.
6. Press the **SCROLL** key to access the Grip Button C function.
7. To exit the System Mode, either turn the transmitter power switch off or press the **SCROLL** and **CHANNEL** keys at the same time.

Grip Button C Function Select (System Mode)

The Grip Button C function of the DX2.0 allows you to activate the Emergency Steering function. This function allows you to override the steering dual rate giving maximum travel, which is useful in oval racing. Use the information below to select the correct Grip Button C assignment for your particular installation.

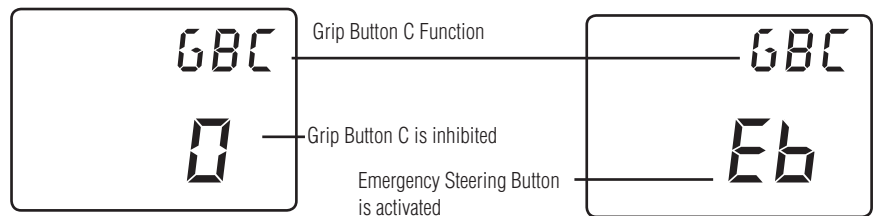

Accessing the Model Name Entry Function

1. Press the **SCROLL** and **CHANNEL** keys at the same time and hold.
2. Turn on the transmitter power switch to enter the System Mode.
3. Press the **SCROLL** key until "GBC" appears on the screen.
4. Press the **INCREASE** or **DECREASE** keys to select the correct Grip Button C function type to be used.
5. Press the **SCROLL** key to access the Data Reset function.
6. To exit the System Mode, either turn the transmitter power switch off or press the **SCROLL** and **CHANNEL** keys at the same time.

Data Reset (System Mode)

The Data Reset function allows you to reset all the programming in the selected model (1 or 2) to the factory default settings. Before using the Data Reset function, it's important to enter the Model Select function and check to make sure the current model number indicated (1 or 2) is the model to which you want to reset to the factory default settings. The Model Select function is described in detail on page 15.

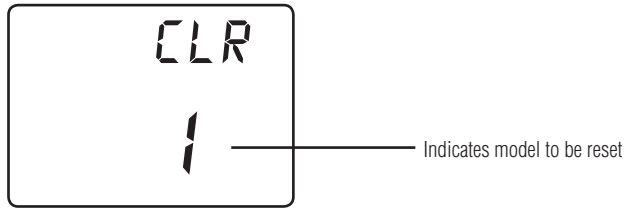

Accessing the Data Reset Function

To access the Data Reset function, follow the steps below:

1. Press the **SCROLL** and **CHANNEL** keys at the same time and hold.
2. Turn on the transmitter power switch to enter the System Mode.
3. Press the **SCROLL** key once until CLR appears on the screen.
4. Press the **INCREASE** and **DECREASE** keys at the same time to reset the data. To confirm that the selected model's programming has been reset, a beep will sound and the model number selected (1 or 2) will stop flashing.
5. To exit the System Mode, either turn the transmitter power switch off or press the **SCROLL** and **CHANNEL** keys at the same time.

To enter the Function Mode, it is necessary to first turn on the transmitter's power switch.

Accessing the Function Mode

Next, press the **SCROLL** key until a beep is heard. The display will change to show the first function listed on the Function Mode flow chart as shown below. Press the **SCROLL** key to scroll down through the functions one by one, as shown in the flow chart. Once the desired function has been reached, use the **CHANNEL** key to select the appropriate channel (if applicable). To adjust the values of the function, simply press the **INCREASE (+)** or **DECREASE (-)** keys until the desired value is displayed on the screen. To exit function mode, press the **SCROLL** and **CHANNEL** keys at the same time. The next time you enter Function mode, you will be returned to the last function accessed.

The End-Point Adjustment feature of the DX2.0 allows the maximum travel of both the

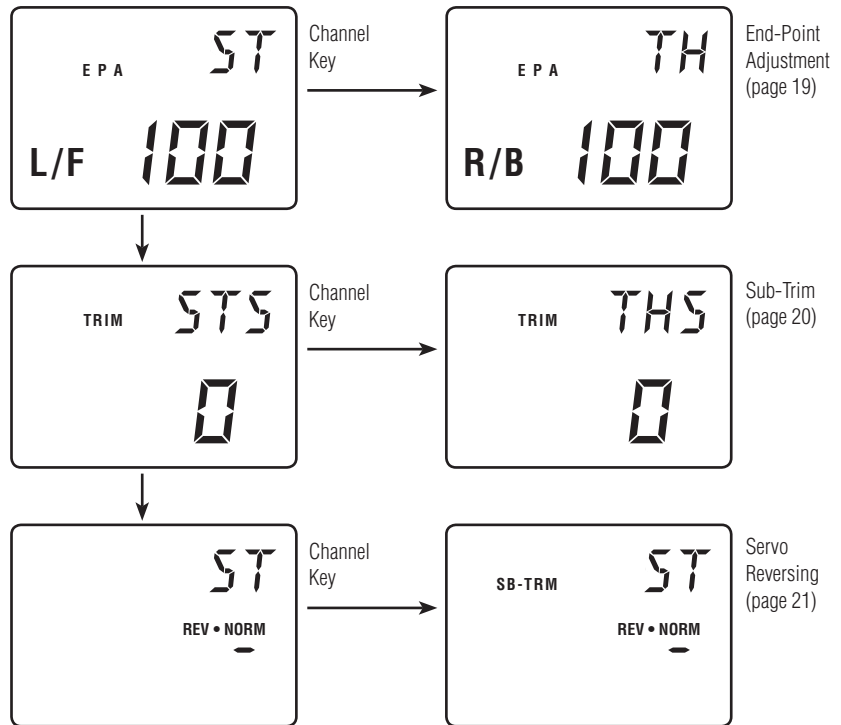

End-Point Adjustment (Function Mode)

steering and throttle servos to be increased or decreased in each direction to achieve the exact servo movement needed. The End-Point Adjustment range is from 0% to 125% and is factory set to 100% for both channels. The value displayed on the screen depends on the current position of the steering wheel, trigger, or trim lever to be adjusted. This feature is very useful either to maximize servo travel or to reduce servo over-travel to eliminate servo binding (servo moves further than control mechanism allows), without the need for mechanical linkage adjustment. The screens below are accessed by turning the wheel to the desired direction to be adjusted (left or right), by moving the trigger to the forward or backward (brake) position, or by moving the Grip Lever A to the forward or back positions.

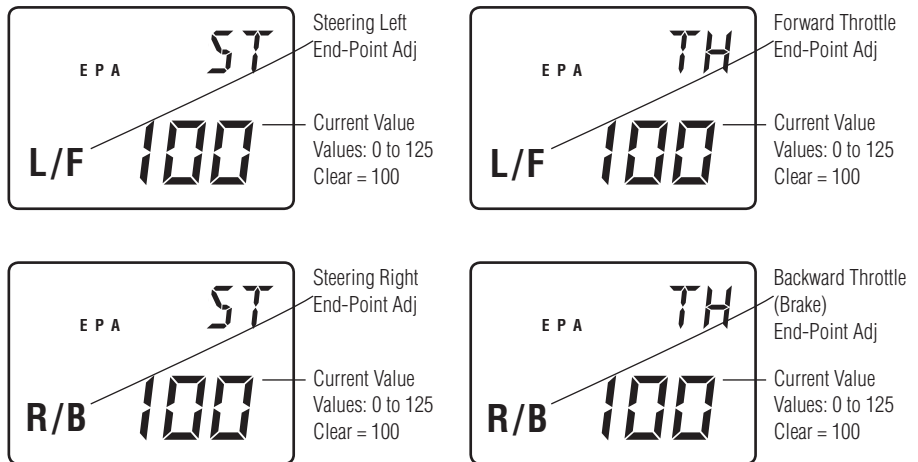

Accessing the End-Point Adjustment Function

1. Turn on the transmitter power switch
2. Press the **SCROLL** key to enter Function mode.
3. Press the **SCROLL** key until "EPA" appears in small letters on the left side of the screen.
4. Press the **CHANNEL** key to select the desired channel to be adjusted.
Steering = ST R/B (steering right) or ST L/F (steering left)
Throttle = TH L/F (forward) or TH R/B (braking or reverse)
5. Move the steering wheel or trigger in the desired direction for adjustment (left/right, forward/reverse or brake). Press the **INCREASE** or **DECREASE** keys to achieve the desired amount of travel. Move the wheel or trigger in the opposite direction to adjust the travel in the opposite direction.
6. Press the **SCROLL** key to access the Sub-Trim Function.
7. To exit the Function Mode, either turn the transmitter power switch off or press the **SCROLL** and **CHANNEL** keys at the same time.

Note: When setting the end-point adjustment values for the steering function, it is suggested that, if possible, the maximum travel values be set to an equal value in both directions to maintain proper steering control.

Sub-Trim (Function Mode)

The Sub-Trim function of the DX2.0 is an electronic trimming feature that allows the neutral position of the servo on either the steering or throttle channel to be moved, while allowing the electronic trim lever for that channel to remain in the center position. This feature is very useful, as it allows the servo arm/wheel position to be moved to help with control linkage installation, eliminating the need to make mechanical linkage adjustments. Although the Sub-Trim function is a very useful feature, it is suggested that only small amounts of sub-trim be used so that no unwanted, non-equal servo travel is created. It is suggested that less than 30 points of Sub-Trim be used during adjustment. If more than 30 points of Sub-Trim are required, it is suggested that a mechanical linkage adjustment be performed.

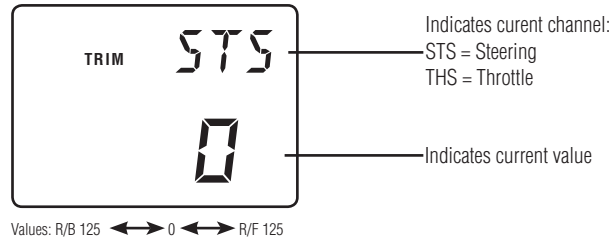

Accessing the Sub-Trim Function

1. Turn on the transmitter power switch.
2. Press the **SCROLL** key to enter the Function Mode.
3. Press the **SCROLL** key until "TRIM" appears in small letters to the left of the screen.
4. Press the **CHANNEL** key to select the channel to be adjusted (Steering, Throttle).
5. Press the **INCREASE** or **DECREASE** keys until the proper servo position is achieved.
6. Press the **SCROLL** key to access the Servo Reversing function.
7. To exit the Function Mode, either turn off the transmitter power switch or press the **SCROLL** and **CHANNEL** keys at the same time.

Servo Reversing (Function Mode)

The Servo Reversing feature of the DX2.0 is a very convenient feature when setting up a new model. The purpose of the Servo Reversing function is to change the direction of the servo rotation in relation to the wheel/trigger movement. The Servo Reversing function is available for the steering and throttle of the DX2.0.

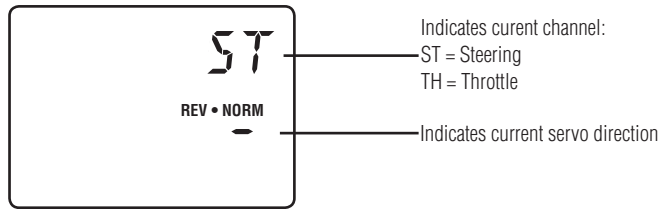

Accessing the Servo Reversing Function

1. Turn the transmitter power switch on.
2. Press the **SCROLL** key to access the Function Mode.
3. Press the **SCROLL** key until “REV•NORM” appears in small letters to the right of the screen.
4. Press the **CHANNEL** key to select the channel to be changed (ST = Steering, TH = Throttle).
5. Press the **INCREASE** or **DECREASE** keys to move the cursor to the desired direction.
6. To exit the Function Mode, either turn off the transmitter power switch or press the **SCROLL** and **CHANNEL** keys at the same time.

Accessing the Direct Trim Mode (Function Mode)

The Direct Trim Mode function of the DX2.0 is accessible through the use of the electronic throttle or steering trim levers, as well as the two electronic grip levers (A&B) located on the upper portion of the grip handle. This function allows for quick trim adjustment of these controls, without the need to access these functions through the four keypad control keys.

To access the Direct Trim Mode function, turn on the transmitter power switch. Next, move the desired trim lever to be adjusted. The appropriate screen for the selected trim lever will be displayed. To adjust, simply move the trim lever in the desired direction until the correct amount of trim is achieved. Once the desired trim is achieved, the screen will return to the Normal display screen after approximately two seconds from the last trim input. If the **INCREASE** or **DECREASE** keys are pressed any time during the two seconds, the system will return to the previous screen in use.

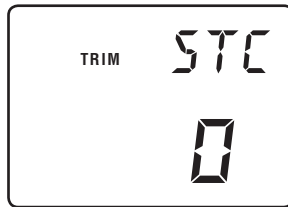

Steering Trim (page 23)

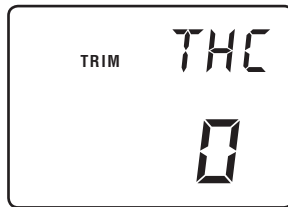

Throttle Trim (page 24)

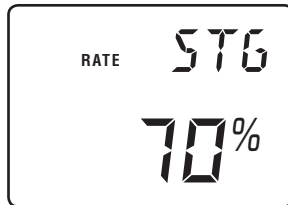

Steering Dual-Rate (Grip Lever B) (page 25)

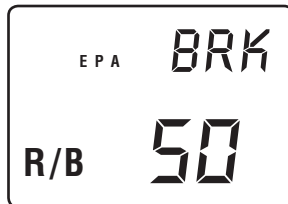

Brake End-Point Adjustment (Grip Lever A)

Steering Trim (STC)

The DX2.0 electronic Steering Trim lever, located just above the steering wheel, allows the center position of the servo to be manipulated in either direction to achieve precise centering of the steering assembly. Steering Travel End-Point Adjustment values (page 19) remain completely independent from the steering trim, unless the trim value exceeds the selected end-point values. (For example: If trim value is set at 30 and end-point values at 15, steering trim will override/alter the end-point value.)

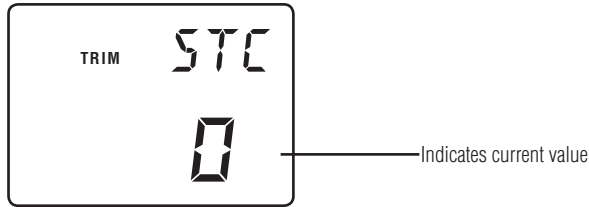

Values: L/F 60 ↔ 0 ↔ R/B 60

Each click will provide 0.3° of trim to the center of the steering servo with a maximum of 12° allowed.

Note: Each click will not always result in a change of the value displayed.

To adjust the steering trim servo position, move the electronic Steering Trim lever either to the left (+) or the right (-). As soon as the trim is moved, the "STC" Steering Trim screen will appear and will continue to be displayed unless the trim lever is untouched for a period of two seconds. To reset the trim value to 0, press the **INCREASE** and **DECREASE** keys at the same time while the "STC" screen is displayed.



Steering Trim Location

Throttle Trim (THC)

The DX2.0's electronic Throttle Trim lever, located to the left of the steering wheel, allows the center position of the servo to be manipulated in either direction to achieve precise centering of the throttle trigger neutral position. Throttle End-Point adjustment values (page 19) remain completely independent from the throttle trim, unless the trim value exceeds the selected end-point values. (For example: If the trim value is set at 40 and the end-point values at 30, Throttle Trim will override/alter the end-point value.)

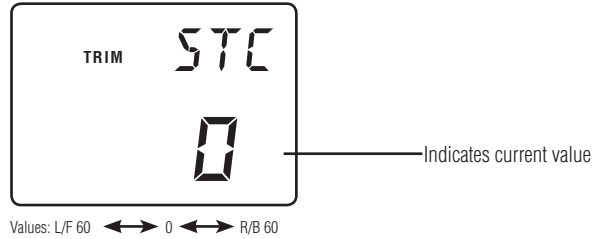

To adjust the Throttle Trim servo position, move the electronic steering trim lever either up (+) or down (-). As soon as the trim is moved, the “THC” Throttle Trim screen will appear and will continue to be displayed unless the trim lever is untouched for a period of two seconds. To reset the trim value to zero, press the **INCREASE** and **DECREASE** keys at the same time while the “THC” screen is displayed.

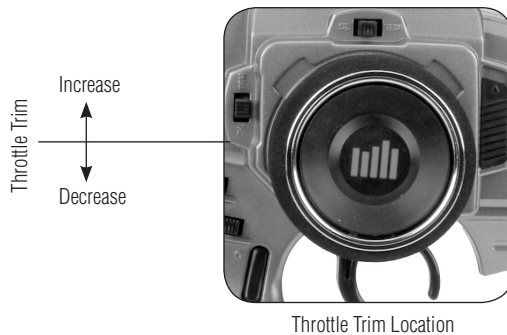

Grip Lever B: Steering Dual Rate Trim Adjustment STG

The Steering Dual Rate Trim Adjustment, located at Grip Lever B, allows the dual rate value (maximum servo travel) to be increased or decreased within a range from 100% through 20% of the total end-point value established in the steering EPA function. This function is very useful in race conditions as it allows you to custom tailor the steering radius and sensitivity for the current track conditions. Please note that since the Dual Rate value shown in the “STG” screen is the percentage of the end-point value established in the steering EPA function, the value will not always increase or decrease each time the Grip Lever B is moved.

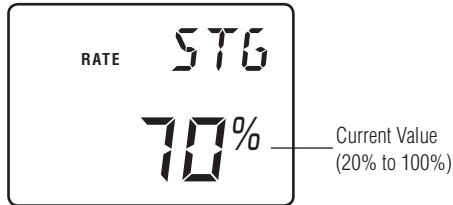

If the Emergency Steering button function (page 16) is active, pressing Grip Button C will restore the steering dual rate to 100% until the button is released.

To adjust the Steering Dual Rate value, move the electronic Grip Lever B either left (-) or right (+). As soon as the trim is moved, the “STG” Steering Dual Rate screen will appear and will continue to be displayed unless the Grip Lever B is untouched for a period of two seconds. To reset the trim value to the factory preset setting of 70%, press the INCREASE and DECREASE keys at the same time while the “STG” screen is displayed.

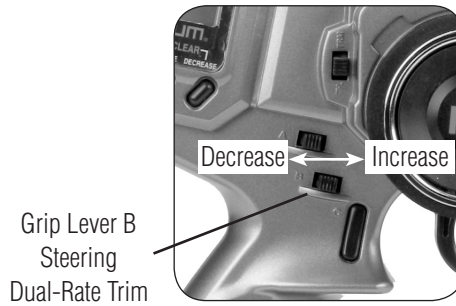

Grip Lever A: Brake End-Point Adjustment BRK

The Brake End-Point Adjustment, located at Grip Lever A, allows the maximum servo travel on the braking side of the throttle trigger to be increased or decreased from 100% to 0% (off). This function is very useful in race conditions as it allows the racer to custom tailor the “panic” brake value to maximize the car’s braking power for the current track conditions. Please note that since the brake end-point value shown in the “BRK” screen is a percentage of the total braking value established in the End-Point Adjustment function (page 19), the value will not always increase or decrease each time the Grip Lever A is moved. To adjust the brake end-point value, move the electronic Grip Lever A either left (–) or right (+). As soon as the grip lever is moved, the BRK End-Point Adjustment screen will appear and will continue to be displayed unless the Grip Lever A is untouched for a period of two seconds.

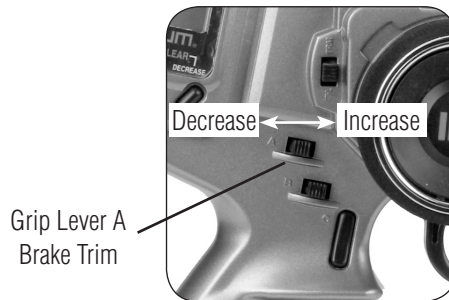
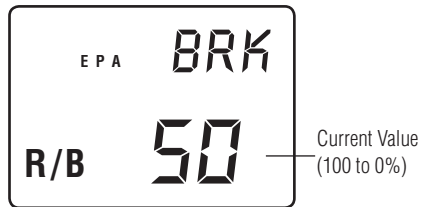

Move the grip lever A to the left or right to decrease or increase values.

DX2.0 Data Sheet

Use the programming sheet to record the information for the programs in your DX2.0 radio system. Feel free to make copies of this programming sheet.

<i>SYSTEM MODE</i>	1	2
MODEL NUMBER		
MODEL NAME		
GRIP BUTTON C	O/E	

<i>FUNCTION MODE</i>	STEERING	THROTTLE
END-POINT ADJUST	L_____ R_____	F_____ B_____
SUB-TRIM		
SERVO REVERSING	REV•NORM	REV•NORM

<i>DIRECT MODE</i>	STEERING	THROTTLE
TRIM VALUES	+/-	+/-
GRIP LEVER B STEERING D/R	%	X
GRIP LEVER A VALUES	BRAKE EPA	
		%

DX2.0 Data Sheet

Use the programming sheet to record the information for the programs in your DX2.0 radio system. Feel free to make copies of this programming sheet.

<i>SYSTEM MODE</i>	1	2
MODEL NUMBER		
MODEL NAME		
GRIP BUTTON C	O/E	

<i>FUNCTION MODE</i>	STEERING	THROTTLE
END-POINT ADJUST	L_____ R_____	F_____ B_____
SUB-TRIM		
SERVO REVERSING	REV•NORM	REV•NORM

<i>DIRECT MODE</i>	STEERING	THROTTLE
TRIM VALUES	+/-	+/-
GRIP LEVER B STEERING D/R	%	
GRIP LEVER A VALUES	BRAKE EPA	
	%	

Warranty and Service Information

Spektrum® 1-Year Limited Warranty Period

Horizon Hobby, Inc. guarantees this product to be free from defects in both material and workmanship for a period of 1 year from the date of purchase.

Limited Warranty & Limits of Liability

Pursuant to this Limited Warranty, Horizon Hobby, Inc. will, at its option, (i) repair or (ii) replace, any product determined by Horizon Hobby, Inc. to be defective. In the event of a defect, these are your exclusive remedies.

This warranty does not cover cosmetic damage or damage due to acts of God, accident, misuse, abuse, negligence, commercial use, or modification of or to any part of the product. This warranty does not cover damage due to improper installation, operation, maintenance, or attempted repair by anyone other than an authorized Horizon Hobby, Inc. service center. This warranty is limited to the original purchaser and is not transferable. In no case shall Horizon Hobby's liability exceed the original cost of the purchased product and will not cover consequential, incidental or collateral damage. Horizon Hobby, Inc. reserves the right to inspect any and all equipment involved in a warranty claim. Repair or replacement decisions are at the sole discretion of Horizon Hobby, Inc. Further, Horizon Hobby reserves the right to change or modify this warranty without notice. REPAIR OR REPLACEMENT AS PROVIDED UNDER THIS WARRANTY IS THE EXCLUSIVE REMEDY OF THE CONSUMER. HORIZON HOBBY, INC. SHALL NOT BE LIABLE FOR ANY INCIDENTAL OR CONSEQUENTIAL DAMAGES. As Horizon Hobby, Inc. has no control over use, setup, final assembly, modification or misuse, no liability shall be assumed nor accepted for any resulting damage or injury. By the act of use, setup or assembly, the user accepts all resulting liability. If you as the purchaser or user are not prepared to accept the liability associated with the use of this product, you are advised to return this product immediately in new and unused condition to the place of purchase.

Safety Precautions

This is a sophisticated hobby product and not a toy. It must be operated with caution and common sense and requires some basic mechanical ability. Failure to operate this product in a safe and responsible manner could result in injury or damage to the product or other property. This product is not intended for use by children without direct adult supervision. The product manual contains instructions for safety, operation and maintenance. It is essential to read and follow all the instructions and warnings in the manual, prior to assembly, setup or use, in order to operate correctly and avoid damage or injury.

Questions, Assistance, and Repairs

Your local hobby store and/or place of purchase cannot provide warranty support or repair. Once assembly, setup or use of the product has been started, you must contact Horizon Hobby, Inc. directly. This will enable Horizon to better answer your questions and service you in the event that you may need any assistance.

Questions or Assistance

For questions or assistance, please direct your email to productsupport@horizonhobby.com, or call 877.504.0233 toll free to speak to a service technician.

Inspection or Repairs

If your product needs to be inspected or repaired, please call for a Return Merchandise Authorization (RMA). Pack the product securely using a shipping carton. Please note that original boxes may be included, but are not designed to withstand the rigors of shipping without additional protection. Ship via a carrier that provides tracking and insurance for lost or damaged parcels, as Horizon Hobby, Inc. is not responsible for merchandise until it arrives and is accepted at our facility. Include your complete name, address, phone number where you can be reached during business days, RMA number, and a brief summary of the problem. Be sure your name, address, and RMA number are clearly written on the shipping carton.

Warranty Inspection and Repairs

To receive warranty service, you must include your original sales receipt verifying the proof-of-purchase date. Provided warranty conditions have been met, your product will be repaired or replaced free of charge. Repair or replacement decisions are at the sole discretion of Horizon Hobby.

Non-Warranty Repairs

Should your repair not be covered by warranty and the expense exceeds 50% of the retail purchase cost, you will be provided with an estimate advising you of your options. You will be billed for any return freight for non-warranty repairs. Please advise us of your preferred method of payment. Horizon Hobby accepts money orders and cashiers checks, as well as Visa, MasterCard, American Express, and Discover cards. If you choose to pay by credit card, please include your credit card number and expiration date. Any repair left unpaid or unclaimed after 90 days will be considered abandoned and will be disposed of accordingly.

Electronics and engines requiring inspection or repair should be shipped to the following address (freight prepaid):

Horizon Service Center
ATTN: Spektrum Service
4105 Fieldstone Road
Champaign, IL 61822

Include your complete name and address information inside the carton and clearly write it on the outer label/return address area. Include a brief summary of the problem. Date your correspondence and be sure that your name and address appear on this enclosure. To receive warranty service, you must include your original sales receipt verifying the proof-of-purchase date. Providing warranty conditions have been met, your equipment will be repaired at no charge or replaced at the discretion of Horizon Hobby.

FCC Information

This device complies with part 15 of the FCC rules. Operation is subject to the following two conditions: (1) This device may not cause harmful interference, and (2) this device must accept any interference received, including interference that may cause undesired operation.

Caution: Changes or modifications not expressly approved by the party responsible for compliance could void the user's authority to operate the equipment.

This product contains a radio transmitter with wireless technology which has been tested and found to be compliant with the applicable regulations governing a radio transmitter in the 2.400GHz to 2.4835GHz frequency range.

The associated regulatory agencies of the following countries recognize the noted certifications for this product as authorized for sale and use:

USA	Canada	Belgium
Denmark	France	Finland
Germany	Italy	Netherlands
Spain	Sweden	UK

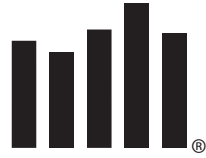

SPEKTRUM®

HORIZON
H O B B Y

© 2006 Horizon Hobby, Inc.
4105 Fieldstone Road
Champaign, Illinois 61822
(877) 504-0233
horizonhobby.com