

SPEKTRUM®

Leaders in Spread Spectrum Technology

DX6i

**6-Channel 10-Model Memory
Full Range DSM2™ 2.4GHz
Radio System for Airplanes
and Helicopters**



TABLE OF CONTENTS

Spektrum's DX6i 6-channel DSM2 Full Range Airplane and Helicopter System	6
DSM2 DualLink Technology	7
ModelMatch	7
Receiver Compatibility	8
Using This Manual	9
Installing the Transmitter Batteries	10
Installing the Batteries	10
Charging Batteries	11
Transmitter Polarity	11
Control Stick Adjustments	12
Removing the Back of the Transmitter	12
Adjusting the Control Stick Tension	12
Control Stick Length Adjustment	13
Advanced Digital Trims	13
Receiver and Servo Installation	14
Receiver Installation	15
Servo Installation	16
How to Range Test the DX6i	17
Range Testing the DX6i	17
Binding	18
SmartSafe Fail-Safe	20
SmartSafe:	20
How SmartSafe works	20
Receiver Power System Requirements	21
Recommended Power System Guidelines	21
Tips on Using 2.4GHz Systems	22
Airplane Quick Start	24
Model Type Selection	24
Servo Reversing	25
Travel Adjust	27
To Access Travel Adjust	27

Aircraft Programming Guide	29
Control Identification and Location - Mode 2	29
Throttle ALT	29
Low Battery Alarm	30
Trainer	30
Setup List	31
Model Type Function	33
Model Name	35
Monitor	37
Reverse	39
Throttle Cut	41
Wing Tail Mix	43
Dual Aileron Wing Type Servo Connections	45
D/R COMBI Switch Assignment	46
Timer	48
Range Check	50
Range Checking a Model	51
How to Range Test the DX6i	51
Range Testing the DX6i	51
Power Setting	52
Contrast	53
Copy/Reset	55
Adjust List	58
Model Select	60
ModelMatch	61
Dual Rate and Exponential	62
Travel Adjust	64
Sub-Trim	66
Flap	68
Programmable Mixing 1 and 2	70
Trim Include Function	74
Differential	75

Helicopter Programming Guide	77
Transmitter Control Identification and Location	77
General Information	78
Throttle ALT	78
Low Battery Alarm	78
Warning Screen for Throttle Hold/Stunt Mode	78
Trainer	78
Programming Using the Roller	78
Setup List	79
Model Type Function	81
Model Name	83
Monitor	85
Reverse	87
Swash Type	89
Throttle Cut	91
D/R COMBI Switch Assignment	93
Timer	95
Setup List Screen	96
Range Check	97
Range Checking a Model	98
How to Range Test the DX6i	98
Range Testing the DX6i	98
Power Setting	99
Contrast	100
Copy/Reset	102
COPY/RESET Screen	103
SETUP LIST Screen	104
COPY/RESET Screen	104
Adjust List	105
Model Select	107
ModelMatch	108
Dual Rate and Exponential	109
Travel Adjust	111
Sub-Trim	113
Gyro	115
Throttle Curve	118
Throttle Trim Setting	120
Pitch Curve	121
Swashplate Mixing	123
Programmable Mixing 1 and 2	125
Trim Include Function	129
Revolution Mixing (only used with non-heading hold gyros)	130
Setup List	131

General Information	132
One-Year Warranty Period	135
Limited Warranty	135
Damage Limits	136
Safety Precautions	136
Questions, Assistance, and Repairs	136
Inspection or Repairs	136
Warranty Inspection and Repairs	137
Non-Warranty Repairs	137
CE Compliance Information for the European Union	138
Instructions for Disposal of WEEE by Users in the European Union	138
Declaration of Conformity	139

SPEKTRUM'S DX6I 6-CHANNEL DSM2 FULL RANGE AIRPLANE AND HELICOPTER SYSTEM

Spektrum's DX6i 6-channel radio system offers advanced programming features normally only available in sophisticated radio systems. The DX6i incorporates 2.4GHz DSM2™ technology, offering full "beyond the limits of sight" range ideal for all types and sizes of electric, gas, and glow-powered aircraft. No longer will you have to wait for a frequency pin or be concerned that someone may inadvertently turn on to your same frequency. With Spektrum™ DSM2 technology, when you're ready to fly any aircraft—from parkflyers and helicopters to giant-scale—simply turn on, and go flying!



DSM2 DUALINK TECHNOLOGY

Your DX6i transmits on the 2.4GHz band and utilizes DSM2 second-generation Digital Spread Spectrum Modulation offering beyond visual range in all types and sizes of aircraft. Unlike conventional narrow band systems, Spektrum's 2.4GHz digital DualLink™ technology is virtually immune to internal and external radio interference.

Included with your DX6i is an AR6200 6-channel receiver. The AR6200 combines an internal and external receiver, offering superior path diversity. The DX6i transmitter simultaneously transmits on two frequencies, creating dual RF paths. This dual path redundancy, plus the fact that each of the two receivers is located in a slightly different location exposes each to a different RF environment and creates a bulletproof RF link in all conditions.

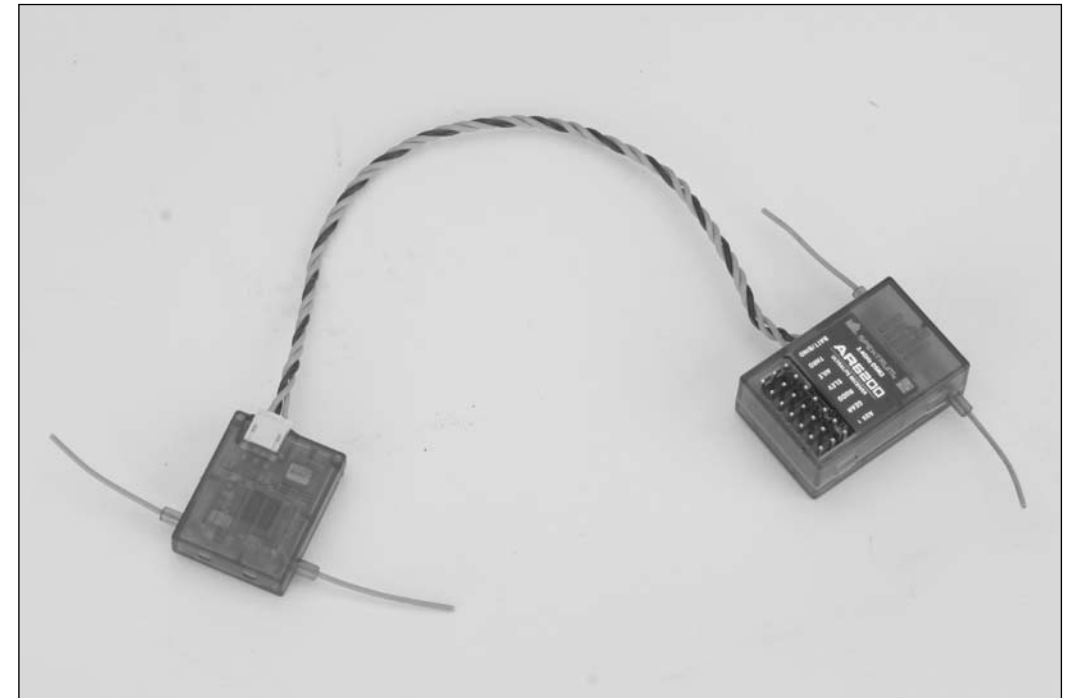

MODELMATCH

With ModelMatch™ technology, you'll never mistakenly attempt to fly your model using the wrong memory again. The DX6i features ModelMatch technology that prevents the operation of a model if the wrong model memory is selected. During binding, the receiver actually learns and remembers the specific model memory (1 of 10) that the transmitter is currently programmed to. Later, if the incorrect model is selected in the transmitter and the receiver is turned on, the model simply won't operate, preventing a possible crash. Change programming to the matching model memory and you are set to fly.

RECEIVER COMPATIBILITY

You'll be glad to know the DX6i is compatible with all current Spektrum and JR brands of DSM aircraft receivers. However when using the DX6i with one of the Spektrum parkflyer receivers, like the AR6000, AR6100, AR6100E, AR6300, etc., it's imperative that these receivers be limited to flying parkflyer-type aircraft and mini and micro helicopters only.

PARKFLYER RECEIVERS

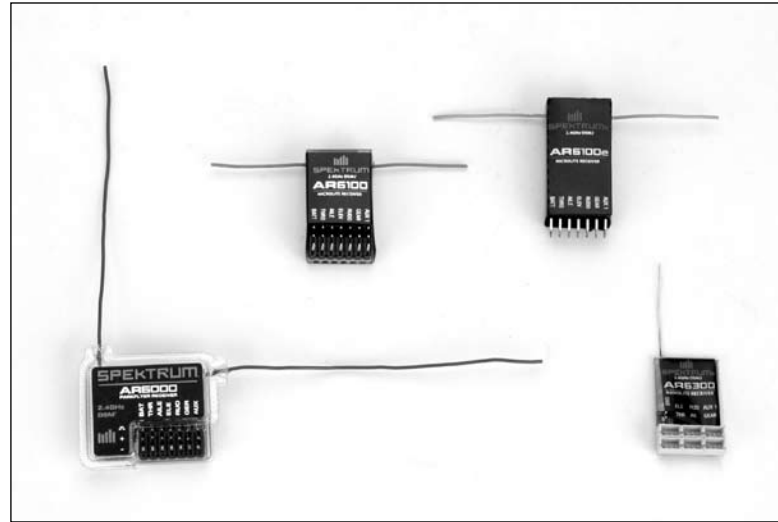

- AR6000
- AR6100
- AR6100E
- AR6300

FULL RANGE DSM2 AIRCRAFT RECEIVERS

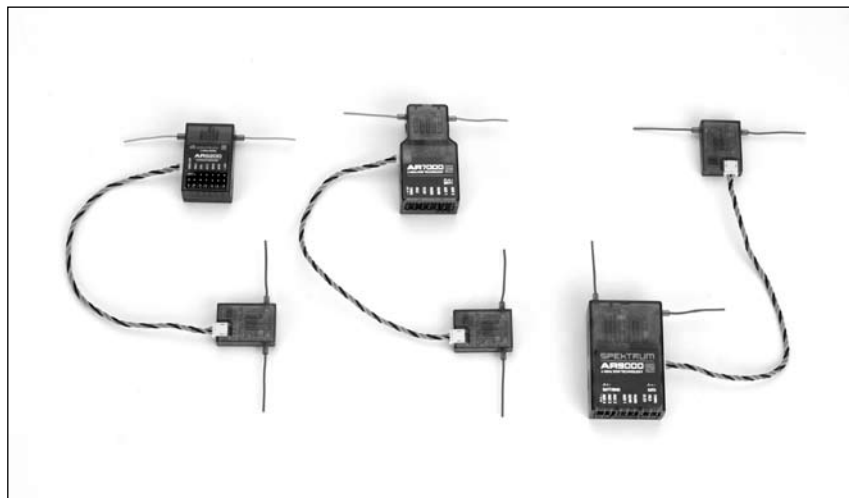

- AR6200
- AR7000
- AR9000

USING THIS MANUAL

For your convenience, this manual is arranged with separate sections for airplane and helicopter software functions. Airplane Programming is located on pages 29 through 76; Helicopter Programming is located on pages 77 through 131. Programming functions are discussed in the same order that they appear on the radio. An explanation of the use and purpose of each feature is provided, followed by an illustration of its LCD display.

INSTALLING THE TRANSMITTER BATTERIES

DX6i systems that are included in some Ready-To-Fly aircraft (like the E-flite Blade 400) require 4 AA batteries while DX6i systems purchased separately include rechargeable NiMH batteries and an overnight charger.

INSTALLING THE BATTERIES

For transmitters that require 4 AA batteries:



Remove the battery door and install 4 AA batteries, noting the polarity of each corresponds with the diagram in the battery holder. Replace the battery door.

Note: Optional NiCd or NiMH 1.2 volt AA rechargeable batteries can also be used. A charge jack is located on the left side of the transmitter for convenient recharging.

Read instructions before charging. Charge only rechargeable batteries. Non-rechargeable batteries may burst causing injury to persons and/or damage to property.

CHARGING BATTERIES

Several versions of the DX6i include rechargeable NiMH batteries and a 4.8-volt charger. It is imperative that you fully charge the transmitter. To do so, using the included wall charger, leave the charger and batteries connected overnight.

The charger supplied with this system is designed to recharge your transmitter batteries at a rate of 150mA. Do not use this charger for equipment other than Spektrum. The charging plug polarity may not be the same and equipment damage can result. During the charging operation, the charger's temperature is slightly elevated. This is normal.

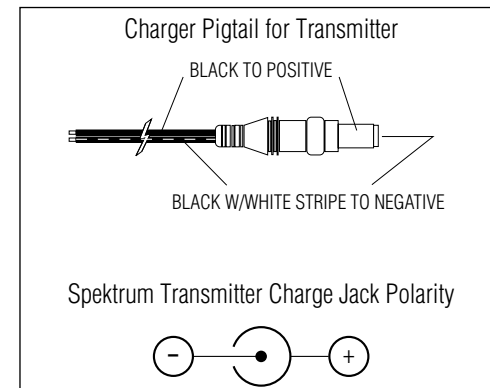

A charging jack is located on the left side of the transmitter. If rechargeable batteries are used they can be conveniently charged without removing them from the transmitter using the charge jack. **IMPORTANT:** All Spektrum charge jacks are center pin negative. This is the opposite of many chargers. Before using a charger, make sure the connector is center pin negative. This can be done using a voltmeter. Also, unlike conventional radio systems that use 8 cells to power the transmitter, the DX6i uses 4 cells. This is due to the electronics being more efficient. When charging, be sure to use a charger designed for 4 cells (4.8-volt battery pack) when charging the transmitter.

Safety Warning: Charge only rechargeable batteries. Non-rechargeable batteries may burst causing injury to persons and/or damage to property.

TRANSMITTER POLARITY

The center pin on all Spektrum transmitters is negative. Therefore, the center pin on all Spektrum chargers is negative, not positive. This is different from many other manufacturers' chargers and radio systems. Beware of improper connections based on "color coded" wire leads, as they may not apply in this instance. You must make sure that the center pin of your Spektrum transmitter is always connected to the negative voltage of your charger for correct polarity hookup.

CONTROL STICK ADJUSTMENTS

REMOVING THE BACK OF THE TRANSMITTER

Begin by removing the batteries from the transmitter. Next, remove the six (6) transmitter back cover screws. Remove the transmitter back, being careful not to cause damage to any components.

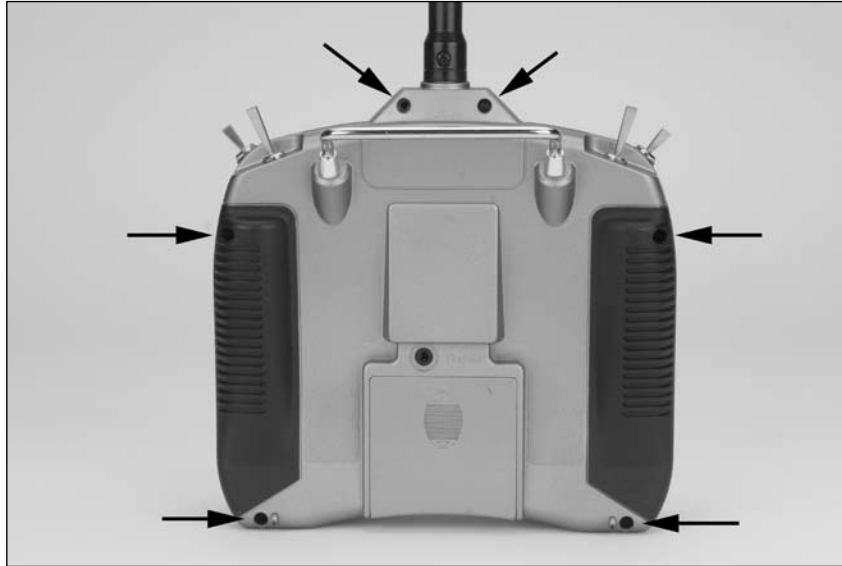

ADJUSTING THE CONTROL STICK TENSION

Adjust each stick tension screw for the desired tension (counterclockwise to loosen stick tension, clockwise to tighten stick tension).

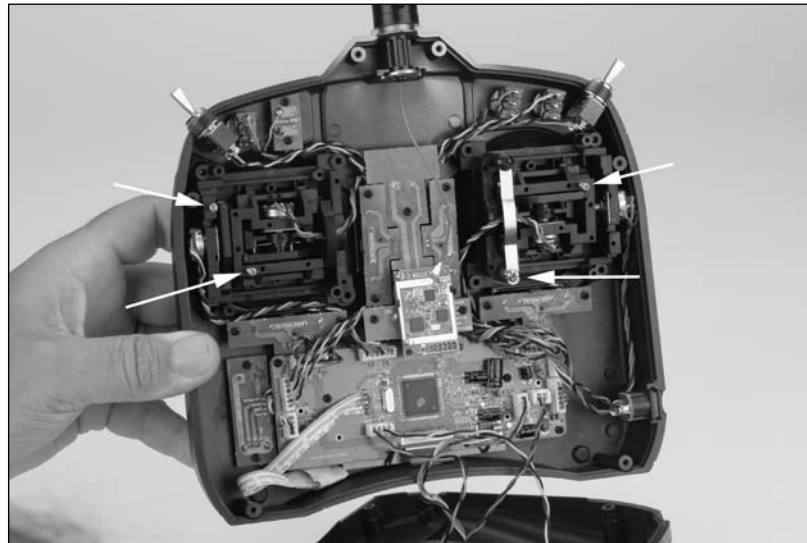

CONTROL STICK LENGTH ADJUSTMENT

The DX6i allows you to adjust the control stick's length. Use the 2mm Allen wrench to loosen the setscrew. Turn the wrench counterclockwise to loosen the screw. Then, turn the stick clockwise to shorten or counterclockwise to lengthen. After the control stick length has been adjusted to suit your flying style, tighten the 2mm setscrew.

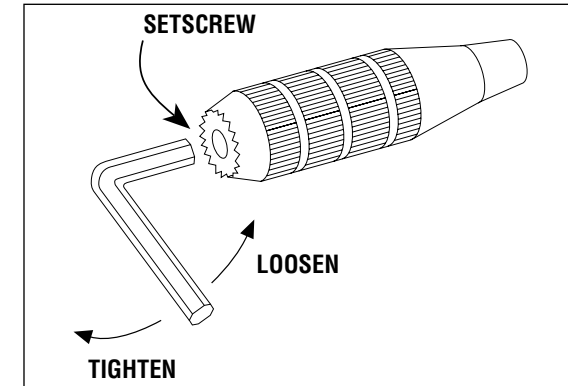

ADVANCED DIGITAL TRIMS

The DX6i employs digital trim levers on aileron, elevator, throttle, and rudder. The ADT (Advanced Digital Trim) feature is designed to automatically store the selected trim values for each model. When a different model is selected, the previously stored trim positions for that model are automatically returned to their previous settings.

Visual trim positions are displayed on the main screen. The trims feature dual speed scrolling. Holding the trim lever for an extended time will cause the trim rate of change to increase.

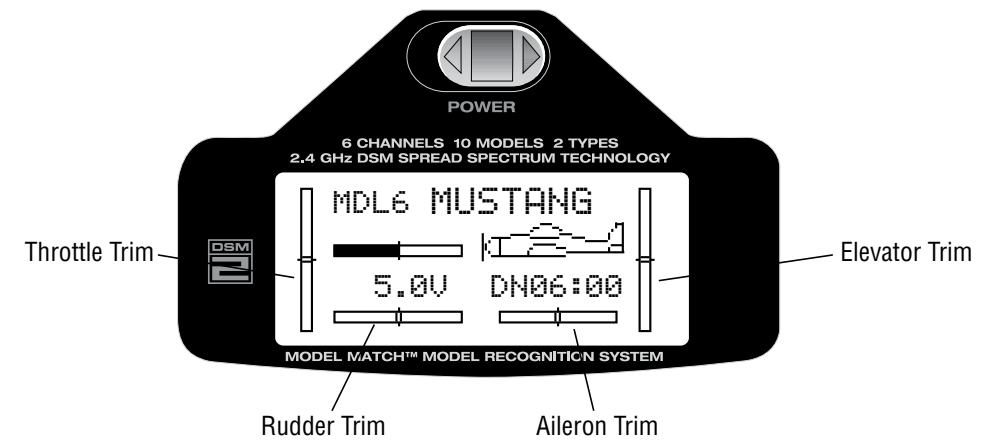

RECEIVER AND SERVO INSTALLATION

The AR6200 incorporates dual receivers, offering the security of dual path RF redundancy. An internal receiver is located on the main PC board, while a second remote receiver is attached to the main board with a 6-inch extension. By locating these receivers in slightly different locations in the aircraft, each receiver is exposed to its own RF environment, greatly improving path diversity (the ability for the receiver to see the signal in all conditions).

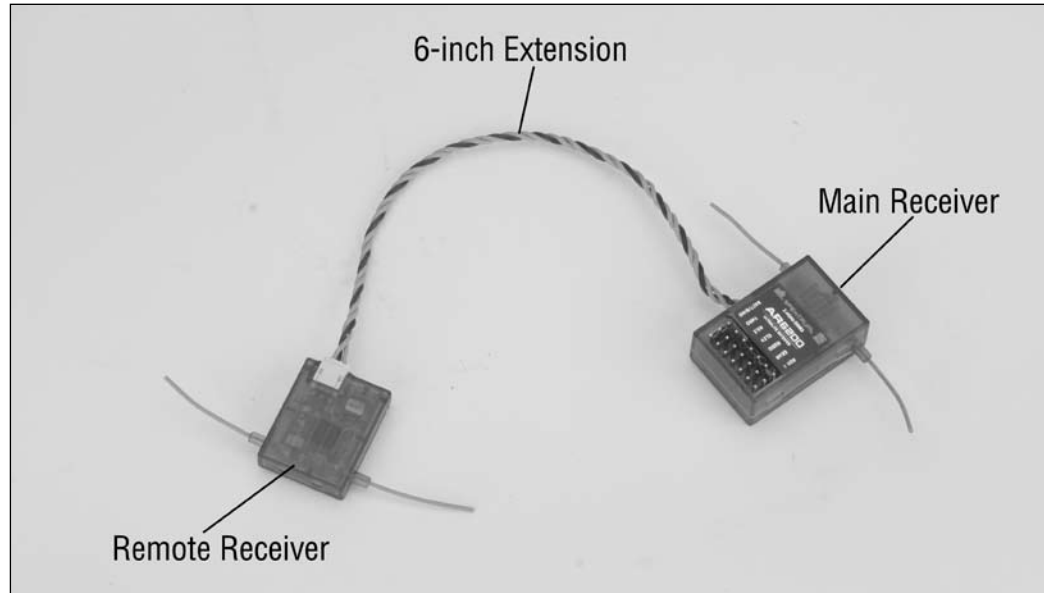

RECEIVER INSTALLATION

Install the main receiver using the same method you would use to install a conventional receiver in your aircraft. Typically, wrap the main receiver in protective foam and fasten it in place using rubber bands or Velcro straps. Alternately, in electric models or helicopters, it's acceptable to use thick double-sided foam tape to fasten the main receiver in place.

Mounting the remote receiver in a slightly different location, even just inches away from the primary receiver, gives tremendous improvements in path diversity. Essentially, each receiver sees a different RF environment and this is key to maintaining a solid RF link, even in aircraft that have substantial conductive materials (i.e. larger gas engines, carbon fiber, pipes, etc.), which can attenuate the signal.

Using servo tape, mount the remote receiver keeping the remote antennas at least 2 inches (51mm) away from the primary antenna. Ideally, the antennas will be oriented perpendicularly to each other, however, we've found this to not be critical. In airplanes, we've found it best to mount the primary receiver in the center of the fuselage on the servo tray and to mount the remote receiver to the side of the fuselage or in the turtle deck.

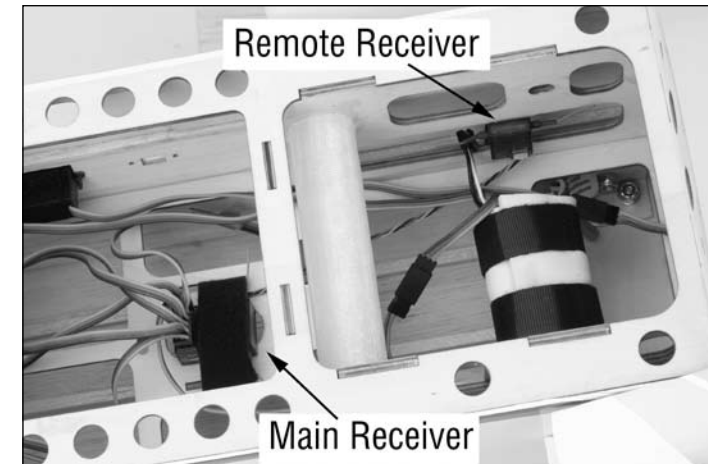

In helicopters, there is generally enough room on the servo tray to achieve the necessary separation. If necessary, a mount can be fashioned using clear plastic to mount the external receiver.

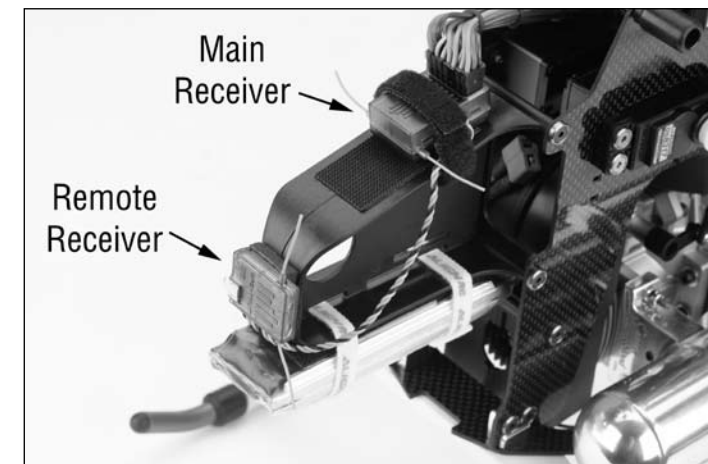

SERVO INSTALLATION

In gas- and glow-powered aircraft where vibration is present, the servos should be mounted using the supplied rubber grommets and bushings. Do not over-tighten the mounting screws. The diagram will assist you in properly mounting the grommets and bushings. In electric and non-powered aircraft, there are many acceptable methods for mounting the servo, including servo tape and even glue. See the information included with your aircraft for the recommendation for installing servo(s) in your aircraft.

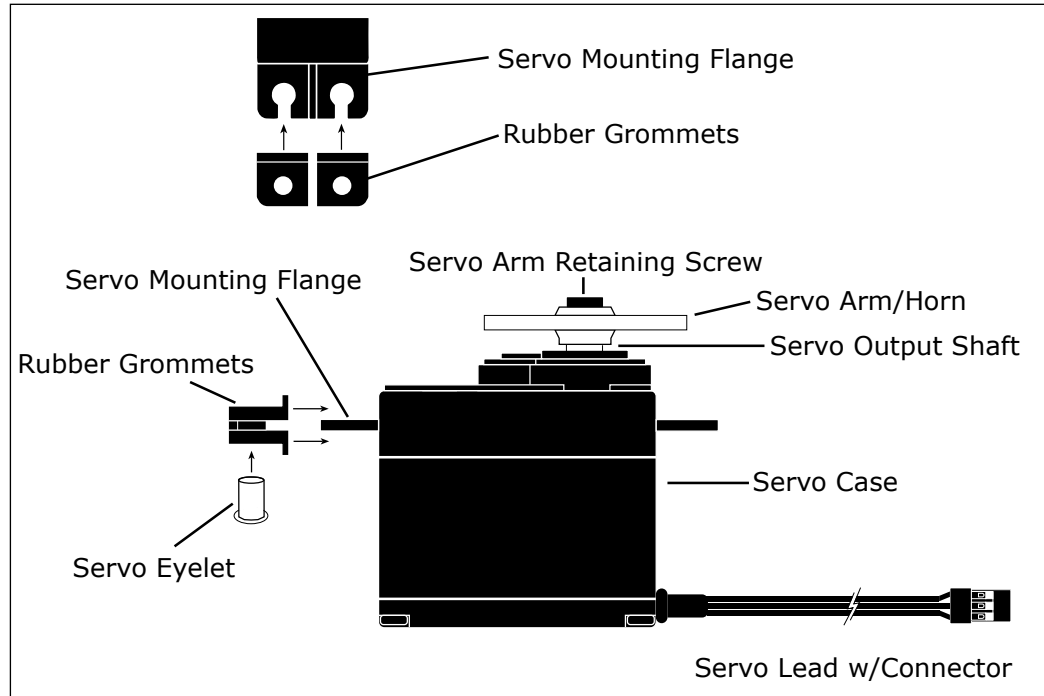

HOW TO RANGE TEST THE DX6I

Before each flying session, and especially with a new model, it is important to perform a range check. The DX6i incorporates a range testing system which, when placed in the RANGE CHECK program and the trainer switch is activated and held, reduces the output power, allowing a range check.

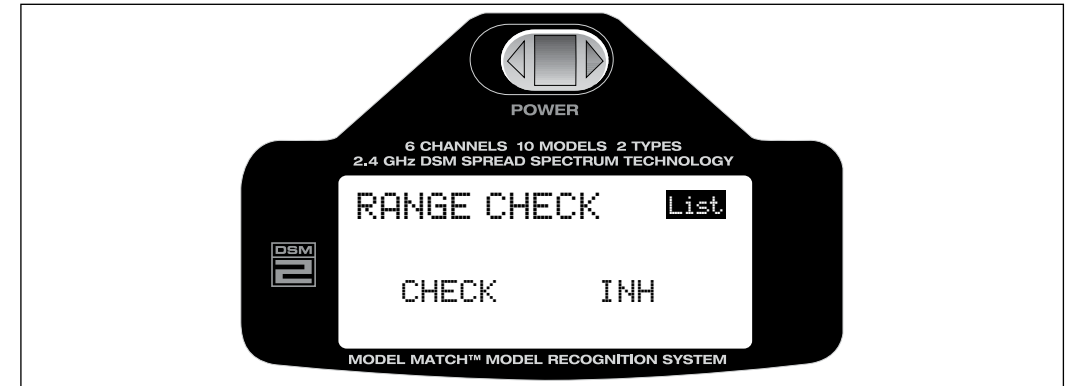

RANGE TESTING THE DX6I

1. With the model resting on the ground, stand 30 paces (approx. 90 feet) away from the model.
2. Face the model with the transmitter in your normal flying position. Place the transmitter in the range test screen (see page 51 or 98) and pull and hold the trainer switch on the top of the transmitter. This causes reduced power output from the transmitter.
3. You should have total control of the model with the trainer switch pulled at 30 paces (90 feet).
4. If control issues exist, call the Horizon Product Support Team at 1-877-504-0233 for further assistance.

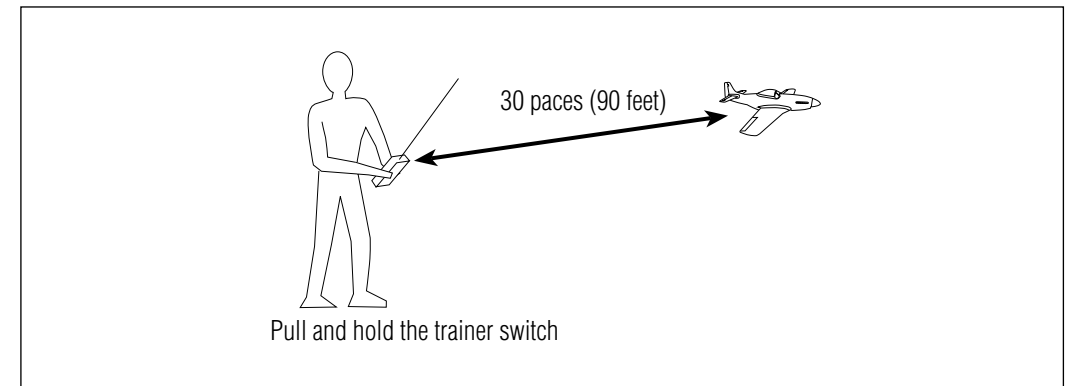

BINDING

The AR6200 receiver must be bound to the transmitter before it will operate. Binding is the process of teaching the receiver the specific code of the transmitter so it will connect to that specific transmitter. Once bound, the receiver will only connect to the transmitter when the previously bound model memory is selected. If another model memory is selected, the receiver will not connect. This feature is called ModelMatch™ and prevents flying a model using the wrong model memory.

1. With the system hooked up as shown, insert the bind plug in the charge plug receptacle.

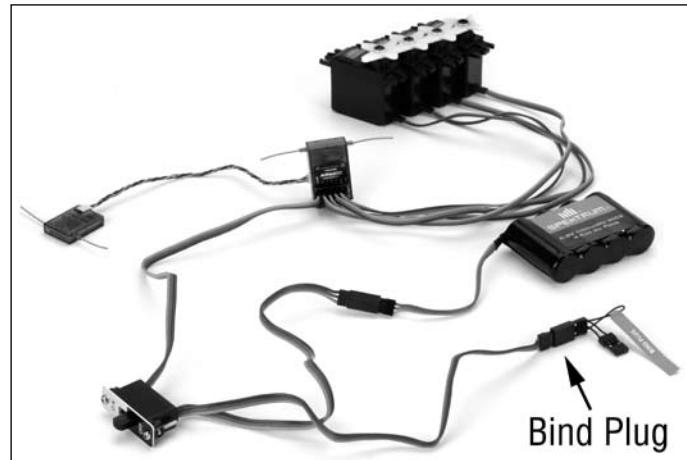

2. Turn on the receiver switch (not included). Note that the LEDs on both receivers should be flashing, indicating that the receiver is ready to bind.

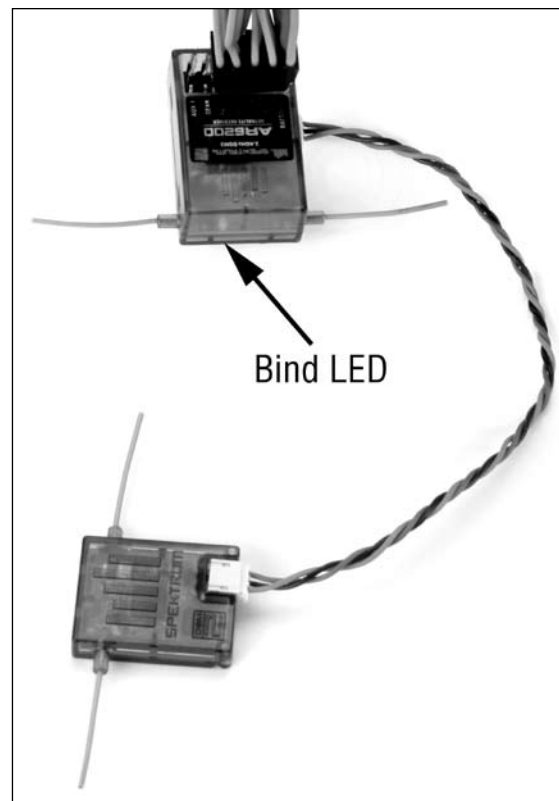

3. Establish the desired fail-safe stick positions: normally low throttle and flight controls neutral.



4. Pull and hold the trainer switch on the top of the transmitter while turning on the power switch. Within a few seconds the system should connect. The LEDs on the receivers should go solid, indicating the system has connected.



5. Remove the bind plug from the charge jack before turning off the receiver and store it in a convenient place.

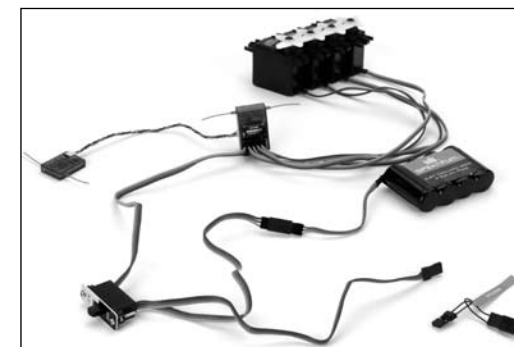

6. After you've programmed your model, it's important to rebind the system so the true low throttle and neutral control surface positions are programmed.

SMARTSAFE FAIL-SAFE

The AR6200 features the SmartSafe™ fail-safe system.

SMARTSAFE:

- Prevents unintentional electric motor response on start-up.
- Eliminates the possibility of over-driving servos on start-up.
- Establishes low-throttle fail safe if the RF signal is lost.
- Maintains last-commanded control surface position in the event of RF link interruption.

Note: Fail-safe positions are stored via the stick and switch positions on the transmitter during binding.

HOW SMARTSAFE WORKS

Smartsafe is ideal for most types of electric aircraft and is also recommended for most types of gas- and glow-powered airplanes and helicopters. Here's how SmartSafe works.

RECEIVER POWER ONLY

When the receiver only is turned on (no transmitter signal is present), the throttle channel has no output, to avoid operating or arming the electronic speed control. In glow-powered models, the throttle servo has no input so it remains in its current position.

AFTER CONNECTION

When the transmitter is turned on, and after the receiver connects to the transmitter, normal control of all channels occurs. After the system makes a connection, if loss of signal occurs, SmartSafe drives the throttle servo only to its preset fail-safe position (low throttle) that was set during binding. All other channels hold their last position. When the signal is regained, the system immediately (less than 4 ms) regains control.

RECEIVER POWER SYSTEM REQUIREMENTS

With all radio installations, it is vital the onboard power system provides adequate power without interruption to the receiver even when the system is fully loaded (servos at maximum flight loads). This becomes especially critical with giant-scale models that utilize multiple high torque/ high current servos. Inadequate power systems that are unable to provide the necessary minimum voltage to the receiver during flight loads have become the number-one cause of in-flight failures. Some of the power system components that affect the ability to properly deliver adequate power include: the selected receiver battery pack (number of cells, capacity, cell type, state of charge), switch harness, battery leads, regulator (if used), power bus (if used).

While Spektrum's receivers' minimum operational voltage is 3.5 volts, it is highly recommended the system be tested per the guidelines below to a minimum acceptable voltage of 4.8 volts during ground testing. This will provide head room to compensate for battery discharging or if the actual flight loads are greater than the ground test loads.

RECOMMENDED POWER SYSTEM GUIDELINES

1. When setting up large or complex aircraft with multiple high torque servos, it's highly recommend that a current and volt-meter (Hangar 9 HAN172) be used. Plug the volt-meter in an open channel port in the receiver and, with the system on, load the control surfaces (apply pressure with your hand) while monitoring the voltage at the receiver. The voltage should remain above 4.8 volts even when all servos are heavily loaded.

Note: The optional Flight Log has a built-in volt meter and it can be used to perform this test.

2. With the current meter in line with the receiver battery lead, load the control surfaces (apply pressure with your hand) while monitoring the current. The maximum continuous recommended current for a single heavy-duty servo/battery lead is three amps while short-duration current spikes of up to five amps are acceptable. Consequently, if your system draws more than three amps continuous or five amps for short durations, a single battery pack with a single switch harness plugged into the receiver for power will be inadequate. It will be necessary to use multiple packs with multiple switches and multiple leads plugged into the receiver.

Note: The Flight log can not measure current draw. Please note that if the flight log is used to measure voltage, the HAN172 current meter still must be used to measure the draw of the servos.

3. If using a regulator, it's important the above tests are done for an extended period of 5 minutes. When current passes through a regulator, heat is generated. This heat causes the regulator to increase resistance, which in turn causes even more heat to build up (thermal runaway). While a regulator may provide adequate power for a short duration, it's important to test its ability over time as the regulator may not be able to maintain voltage at significant power levels.
4. For really large aircraft or complex models (for example 35% and larger or jets) multiple battery packs with multiple switch harnesses are necessary or in many cases one of the commercially available power boxes/ busses is recommended. No matter what power systems you choose, always carry out test #1 above making sure that the receiver is constantly provided with 4.8 volts or more under all conditions.
5. The latest generation of Nickel Metal Hydride batteries incorporate a new chemistry mandated to be more environmentally friendly. These batteries, when charged with peak detection fast chargers, have tendencies to false peak (not fully charge) repeatedly. These include all brands of NiMH batteries. If using NiMH packs be especially cautious when charging making absolutely sure that the battery is fully charged. It is recommended to use a charger that can display total charge capacity. Note the number of mAh put into a discharged pack to verify it has been charged to full capacity.

TIPS ON USING 2.4GHZ SYSTEMS

Your DSM2 equipped 2.4GHz system is intuitive to operate, functioning nearly identically to 72MHz systems. Following are a few common questions from customers:

1. Q: Which do I turn on first, the transmitter or the receiver?

A: It doesn't matter, if the receiver is turned on first-the throttle channel doesn't put out a pulse position at this time, preventing the arming of electronic speed controllers, or in the case of an engine powered aircraft, the throttle servo remains in its current position. When the transmitter is then turned on the transmitter scans the 2.4GHz band and acquires two open channels. Then the receiver that was previously bound to the transmitter scans the band and finds the GUID (Globally Unique Identifier code) stored during binding. The system then connects and operates normally. If the transmitter is turned on first, the transmitter scans the 2.4GHz band and acquires two open channels. When the receiver is turned on, the receiver scans the 2.4GHz band looking for the previously stored GUID, and when it locates the specific GUID code and confirms uncorrupted repeatable packet information, the system connects and normal operation takes place. Typically this takes 2 to 6 seconds.

2. Q: Sometimes the system takes longer to connect and sometimes it doesn't connect at all. Why?

A In order for the system to connect (after the receiver is bound) the receiver must receive a large number of continuous (one after the other) uninterrupted perfect packets from the transmitter in order to connect. This process is purposely critical of the environment ensuring that it's safe to fly when the system does connect. If the transmitter is too close to the receiver (less than 4 feet) or if the transmitter is located near metal objects (metal transmitter case, the bed of a truck, the top of a metal work bench, etc.) connection will take longer and in some cases connection will not occur as the system is receiving reflected 2.4GHz energy from itself and is interpreting this as unfriendly noise. Moving the system away from metal objects or moving the transmitter away from the receiver and powering the system up again will cause a connection to occur. This only happens during the initial connection. Once connected the system is locked, and should a loss of signal occur (fail-safe), the system connects immediately (4ms) when signal is regained.

3. Q: I've heard that the DSM system is less tolerant of low voltage. Is this correct?

A: All DSM receivers have an operational voltage range of 3.5 to 9 volts. With most systems this is not a problem as in fact most servos cease to operate at around 3.8 volts. When using multiply high current draw servos with a single or inadequate battery/ power source, heavy momentary loads can cause the voltage to dip below this 3.5 volt threshold thus causing the entire system (servos and receiver) to brown out. When the voltage drops below the low voltage threshold (3.5 volts), the DSM receiver must reboot (go through the start up process of scanning the band and finding the transmitter) and this can take several seconds.

Note: Receivers manufactured after July of 2007 offer a quick connect feature that reconnect immediately when recovering from a low voltage "brown out."

Please read the receiver power requirement on page 21 as this explains how to test for and prevent this occurrence.

4. Q: Sometimes my receiver loses its bind and won't connect, requiring rebinding. What happens if the bind is lost in flight?

A: The receiver will never lose its bind unless it's instructed to. It's important to understand that during the binding process the receiver not only learns the GUID (code) of the transmitter but the transmitter learns and stores the type of receiver that it's bound to. If the trainer switch is pulled on the transmitter at any time and the transmitter is turned on, the transmitter looks for the binding protocol signal from a receiver. If no signal is present, the transmitter no longer has the correct information to connect to a specific receiver and in essence the transmitter has been "unbound" from the receiver. We've had several customers using transmitter stands or trays that unknowingly depress the bind button and the system is then turned on, losing the necessary information to allow the connection to take place. We've also had customers that didn't fully understand the range test process and pull the trainer switch before turning on the transmitter, also causing the system to "lose its bind." If the system fails to connect, one of the following has occurred:

- The wrong model has been selected in the model memory (ModelMatch).
- The transmitter is near conductive material (transmitter case, truck bed, etc.) and the reflected 2.4GHz energy is preventing the system from connecting. (See #2 above)
- The trainer switch was pulled and the radio was turned on unknowingly (or knowingly) previously, causing the transmitter to no longer recognize the receiver.

AIRPLANE QUICK START

The following covers a basic 4-channel airplane with a single rate. For more details on programming for the aircraft mode, see the Aircraft section of this manual.

MODEL TYPE SELECTION

SELECTING AIRPLANE MODE

Press the ROLLER and hold while turning on the transmitter. When SETUP LIST appears on screen, release the roller.

MODEL TYPE appears on the lower section of the screen.

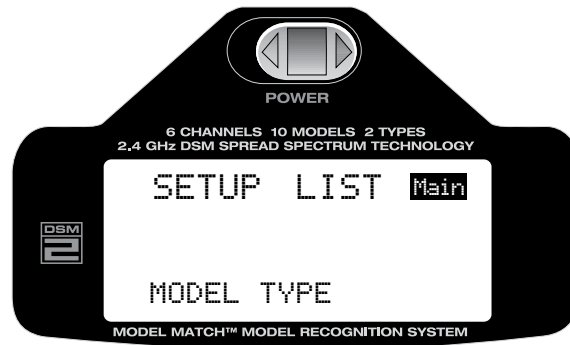

Rotate the roller to highlight MODEL TYPE.

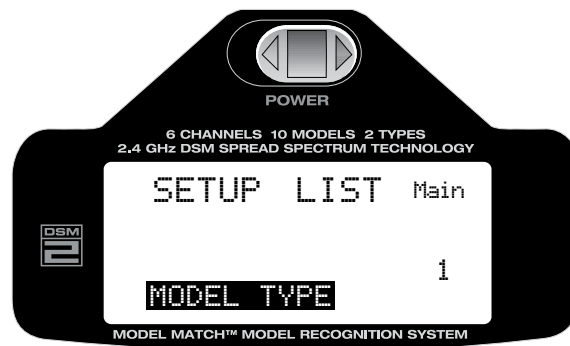

Press the ROLLER to access the MODEL TYPE function. If ACRO is highlighted on screen, proceed to SERVO.

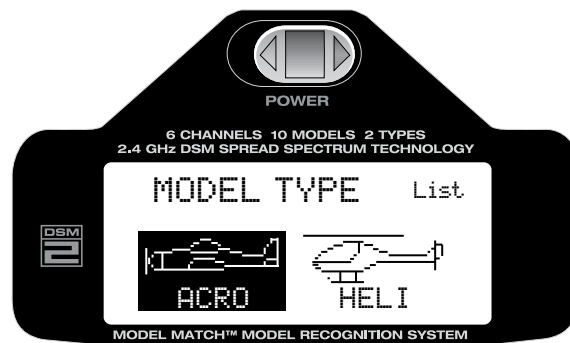

SERVO REVERSING

TO ACCESS SERVO REVERSING

Press the ROLLER and hold while turning on the transmitter. When SETUP LIST appears on screen release the roller.

You can also turn the transmitter on and press the scroll wheel. Scroll down to the setup list and press the scroll wheel to get to this screen.

MODEL TYPE appears on the lower section of the screen.

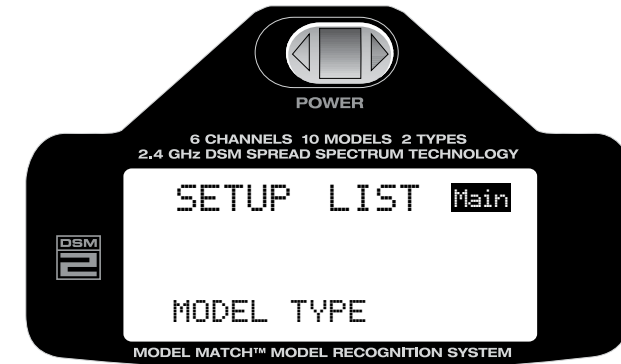

Rotate the ROLLER to the right until REVERSE is highlighted on screen.

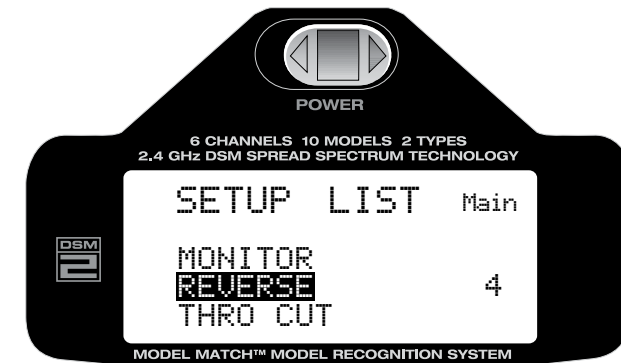

Press the roller to access the reversing function.

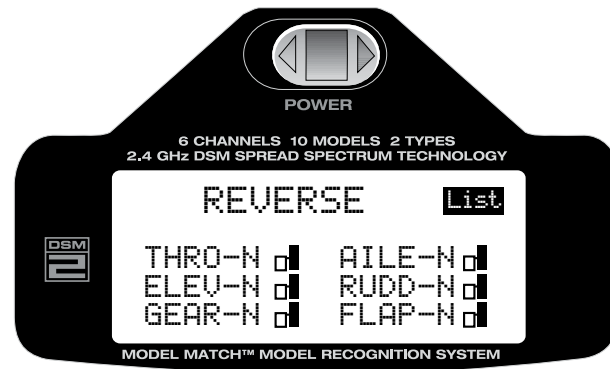

Rotate the roller to highlight the desired channel then press the roller to select that channel.

With the desired channel selected rotate the roller to select N- normal or R reverse.

When the reverse direction is correct, press the roller to deselect the channel.

To return to the SETUP LIST rotate the roller and highlight LIST then press the roller.

TRAVEL ADJUST

TO ACCESS TRAVEL ADJUST

With the transmitter already powered on and in the main screen, press and release the ROLLER to enter the ADJUST LIST.

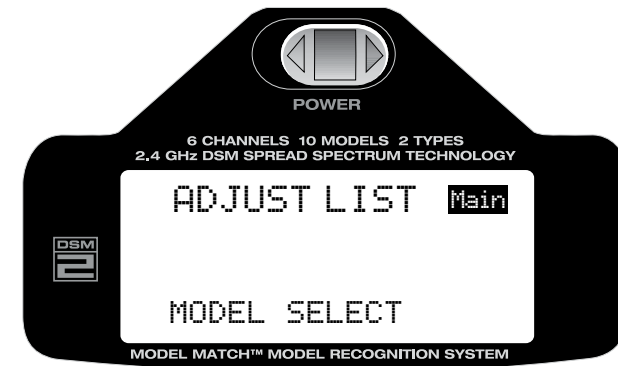

Rotate the ROLLER to the right until TRAVEL ADJ is highlighted on screen.



Press the roller to access the TRAVEL ADJ function.

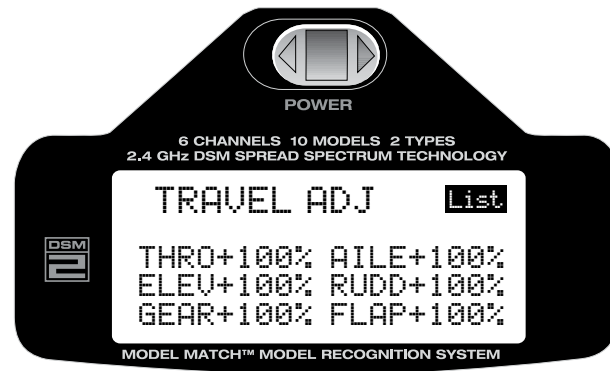

Rotate the roller to highlight the desired channel.

Move the corresponding channel's stick or switch in the desired direction and hold the stick you wish to change the travel adjust and note the arrow direction then press the roller to select that channel and direction.

Rotate the roller to adjust the travel adjust values in that selected direction only.

When the desired value is selected press the roller to deselect the channel.

Repeat for all other channels.

This completes the basic Quick Start setup for your airplane. For additional features like Dual and Expo rates, Mixing, etc, see the appropriate pages listed in the table of contents.

Note: If your airplane's ailerons are controlled independently by two servos, see "WING TAIL MIX Selection" on page 43 for specifics on programming DUAL AILERONS.

AIRCRAFT PROGRAMMING GUIDE

CONTROL IDENTIFICATION AND LOCATION - MODE 2



THROTTLE ALT

The Throttle ALT function makes the throttle stick trim active only when the throttle stick is at less than half throttle. This allows accurate idle adjustments without affecting the mid to high throttle position.

LOW BATTERY ALARM

When the battery voltage drop below 4.3 volts an alarm will sound and the screen will flash.

TRAINER

The DX6i offers a Trainer function that allows the transmitter to operate as a master or slave. The trainer switch is located on the back left of the transmitter. (The trainer switch is located on the back right on Mode 1 transmitters.)

MASTER

The transmitter can be used as a master but the slave transmitter must have the same programming (i.e. reverse, travel adjust, dual rates, mixes, sub trims, etc.) as the master.

SLAVE MODE

When using the transmitter as a slave with another DX6i, it's necessary to match all the programmable settings (i.e. reverse, travel adjust, etc.).

PROGRAMMING USING THE ROLLER

The roller is used to access all programming functions.

- Pressing and releasing the roller accesses/ enters the selected function
- Rolling the roller changes values or selections

TO ACCESS THE MAIN SCREEN:

Anytime the transmitter is turned on, the main screen will appear.

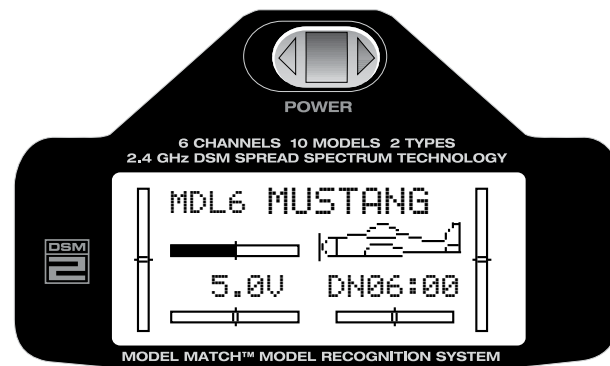

TO RETURN TO THE MAIN SCREEN:

From the ADJUST LIST or SETUP LIST screens, pressing and holding the roller for more than three seconds then releasing the roller will return the display to the main screen.

TO RETURN TO THE LIST OR SETUP SCREEN:

From the any program function screens, pressing and holding the roller for more than three seconds then releasing the roller will return the display to the LIST or SETUP screen.

SETUP LIST

The SETUP list contains the programming functions that are normally only used during the initial setup of the model. (i.e. model type, servo reverse, model name).

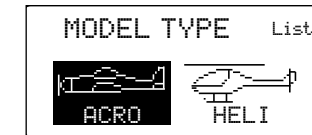

Model Type (Page 33)

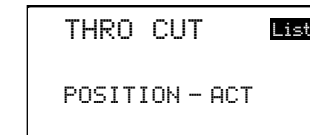

Throttle Cut (Page 41)

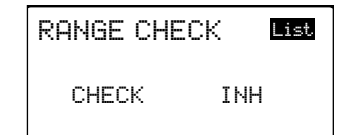

Range Check (Page 50)

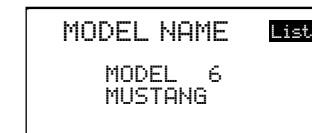

Model Name (Page 35)

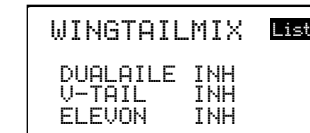

Wing Tail Mix (Page 43)

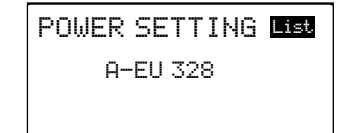

Power Setting (Page 52)

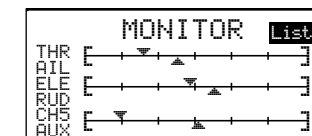

Monitor (Page 37)

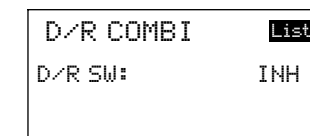

D/R Combi (Page 46)

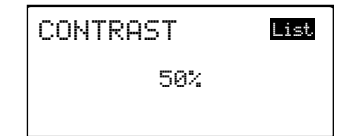

Contrast (Page 53)

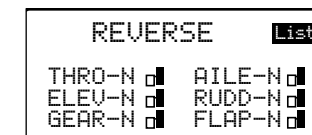

Reverse (Page 39)

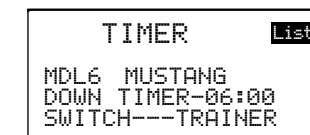

Timer (Page 48)

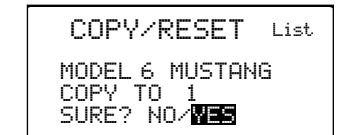

Copy/Reset (Page 55)

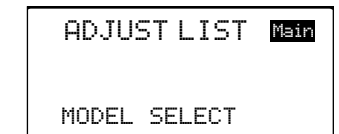

Adjust List (Page 58)

The SETUP LIST includes programming functions that are normally used during set up. Setup programming functions for airplanes include those listed above.

TO ENTER THE SETUP LIST

Press the ROLLER and hold while turning on the transmitter. When SETUP LIST appears on screen, release the roller.

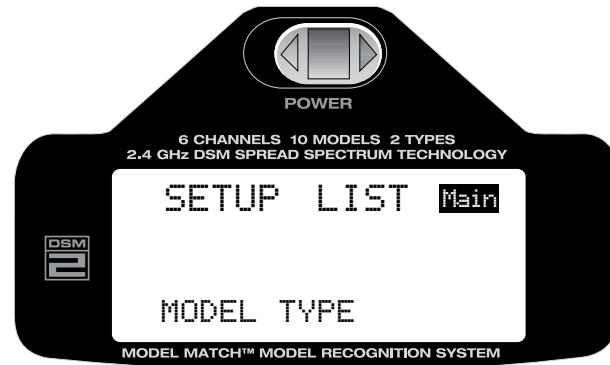

Alternatively the setup list can be accessed from the main screen by pressing the roller to access the ADJUST LIST then scrolling through the ADJUST LIST by rolling the roller to highlight SETUP LIST; then press the roller and the SETUP LIST will appear.

TO EXIT THE SETUP LIST

Press and hold the roller for more than 3 seconds, then release the roller and the system will return to the main screen.

Alternatively rotating the roller to highlight MAIN in the upper right corner then pressing the roller will return the system to the main screen.

Turning the transmitter off then back on will return the transmitter to the main screen.

MODEL TYPE FUNCTION

The DX6i features two programming types: Airplane and Helicopter. The DX6i can memorize data for up to 10 models individually and the model type will automatically be stored with each model memory.

TO ENTER THE MODEL TYPE FUNCTION

Press the ROLLER and hold while turning on the transmitter. When SETUP LIST appears on screen release the roller.

Alternatively the setup list can be accessed from the main screen by pressing the roller to access the ADJUST LIST then scrolling through the ADJUST LIST by rolling the roller to highlight SETUP LIST then press the roller.

MODEL TYPE appears on the lower section of the screen.

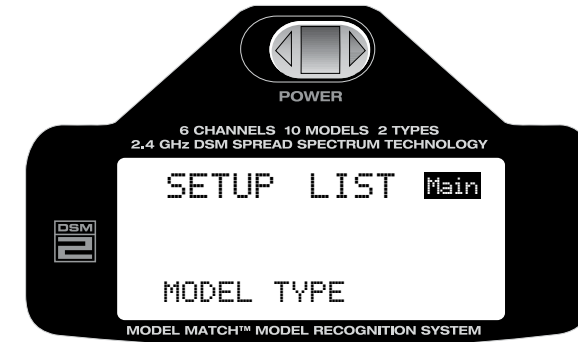

Rotate the roller to highlight MODEL TYPE then press the roller to access the MODEL TYPE function.

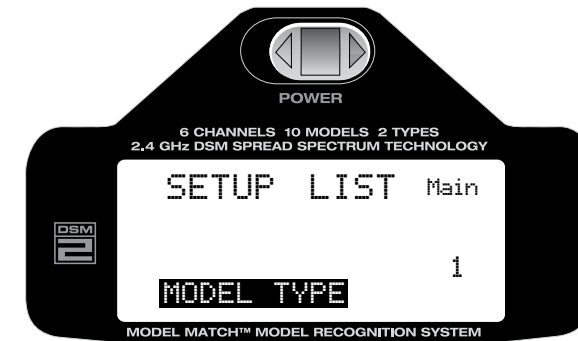

TO SELECT A MODEL TYPE

Rotate the roller to highlight the desired model type ACRO (airplane) or HELI helicopter then press the roller to program that model type in model memory. Note that when changing model type all programming from the previous model will be erased and the new model will be reset to factory default settings.

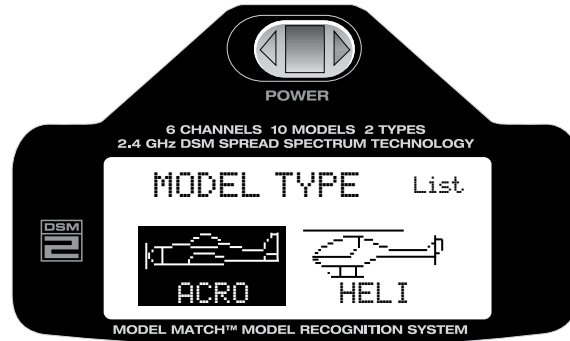

TO RETURN TO THE MAIN SCREEN

Press and hold the roller for more than 3 seconds then release the roller and the system will return to the main screen.

TO RETURN TO THE SETUP LIST

Rotate the roller to highlight LIST in the upper right corner then pressing the roller will return the system to the SETUP LIST screen.

MODEL NAME

The Model Name function is used to input and assign the model's name to a specific memory, allowing easy identification of each model's program. Each model's name is displayed on the main screen when that model is selected. Up to eight characters that include numbers and letters are available.

TO ENTER THE MODEL NAME FUNCTION

Press the ROLLER and hold while turning on the transmitter. When SETUP LIST appears on screen release the roller.

Alternatively the setup list can be accessed from the main screen by pressing the roller to access the ADJUST LIST then scrolling through the ADJUST LIST by rolling the roller to highlight SETUP LIST then press the roller.

MODEL TYPE appears on the lower section of the screen.

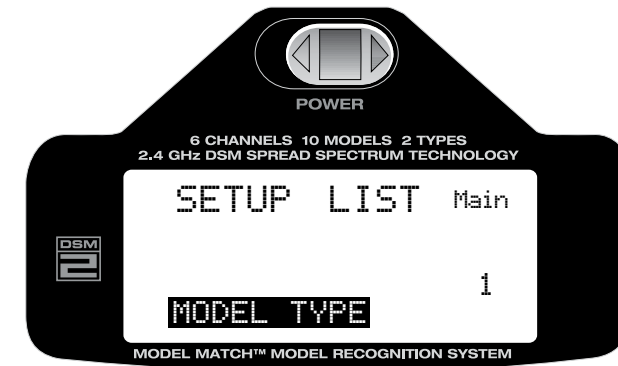

Rotate the roller to highlight MODEL NAME then press the roller to access the MODEL NAME function.

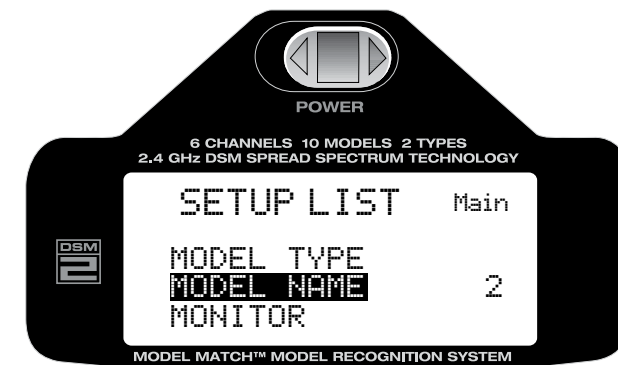

TO PROGRAM A MODEL NAME

Rotate the roller to highlight the block below the MODEL # shown on the screen then press the roller.

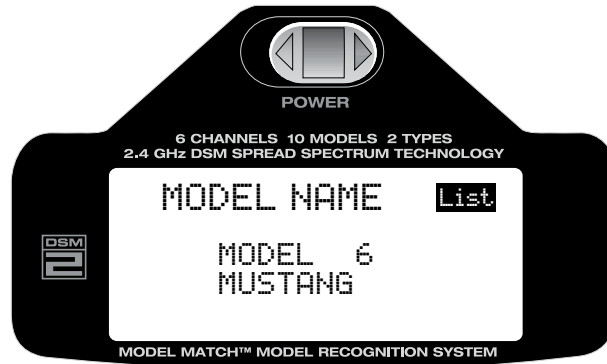

Rotate the roller to select the desired position that you wish to assign a letter or number then press the roller to access the numbers or letter characters.

Rotate the roller to scroll through the letters/ numbers and when the desired number is selected pressing the roller will assign it to the selected position.

Repeat this process to complete the model name then highlight OK! When finished.

TO RETURN TO THE MAIN SCREEN

Press and hold the roller for more than 3 seconds then release the roller and the system will return to the main screen.

TO RETURN TO THE SETUP LIST

Rotate the roller to highlight LIST in the upper right corner then pressing the roller will return the system to the SETUP LIST screen.

MONITOR

The servo monitor screen serves as a useful tool when programming your radio. It displays servo movement and direction when different programming functions, sticks and/or switches are moved.

TO ACCESS THE SERVO MONITOR

Press the ROLLER and hold while turning on the transmitter to enter the SETUP LIST. When SETUP LIST appears on screen release the roller.

Alternatively the setup list can be accessed from the main screen by pressing the roller to access the ADJUST LIST then scrolling through the ADJUST LIST by rolling the roller to highlight SETUP LIST then press the roller.



Rotate the ROLLER to the right until SERVO is highlighted on screen.

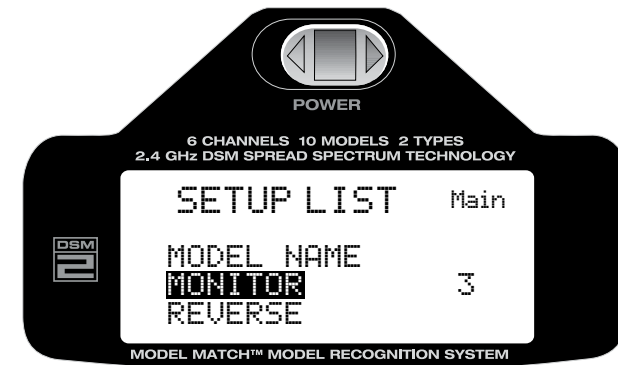

Press the roller to access the Servo monitor screen.

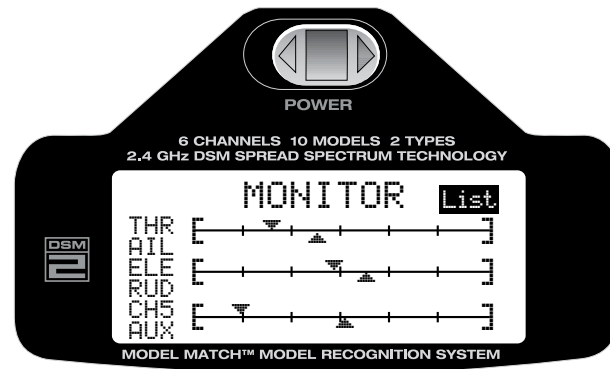

TO RETURN TO THE MAIN SCREEN

Press and hold the roller for more than 3 seconds then release the roller and the system will return to the main screen.

TO RETURN TO THE SETUP LIST

Rotate the roller to highlight LIST in the upper right corner then pressing the roller will return the system to the SETUP LIST screen.

REVERSE

The Reverse Switch function allows electronic means of reversing the servo's throw. Servo reversing is available for all six channels.

TO ACCESS THE REVERSE FUNCTION

Press the ROLLER and hold while turning on the transmitter. When SETUP LIST appears on screen release the roller.

Alternatively the setup list can be accessed from the main screen by pressing the roller to access the ADJUST LIST then scrolling through the ADJUST LIST by rolling the roller to highlight SETUP LIST then press the roller.

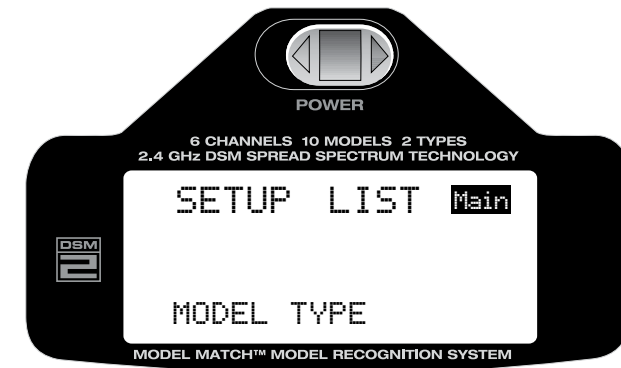

Rotate the roller to highlight REVERSE then press the roller to access the REVERSE function.

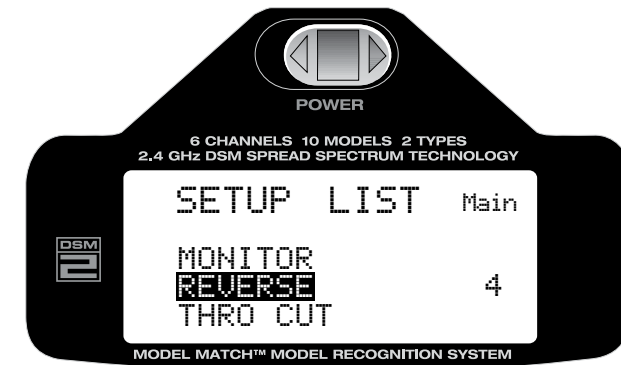

TO REVERSE A CHANNEL

Rotate the roller to highlight the desired channel then press the roller to select that channel.

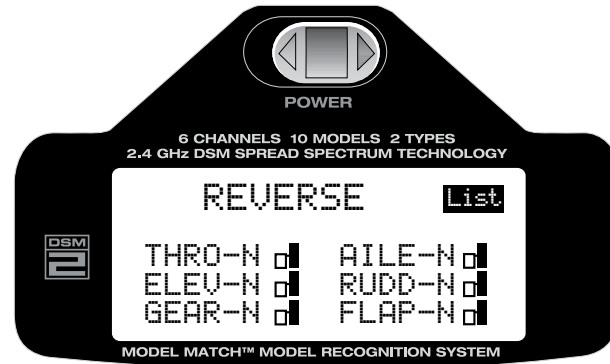

With the desired channel selected rotate the roller to select (N=Normal, R=Reverse).

- THRO: Throttle
- AILE: Aileron
- ELEV: Elevator
- RUDD: Rudder
- GEAR: Retractable Landing Gear
- FLAP: Flap

When the reverse direction is selected press the roller to deselect the channel.

TO RETURN TO THE MAIN SCREEN

Press and hold the roller for more than 3 seconds then release the roller and the system will return to the main screen.

TO RETURN TO THE SETUP LIST

Rotate the roller to highlight LIST in the upper right corner then pressing the roller will return the system to the SETUP LIST screen.

THROTTLE CUT

The DX6i offers a Throttle Cut function. When the Throttle Cut button is pressed, the throttle moves to the low throttle, low trim position, allowing the safe and convenient shut down of the engine.

TO ACTIVATE THE THROTTLE CUT FUNCTION

Press the ROLLER and hold while turning on the transmitter. When SETUP LIST appears on screen release the roller.

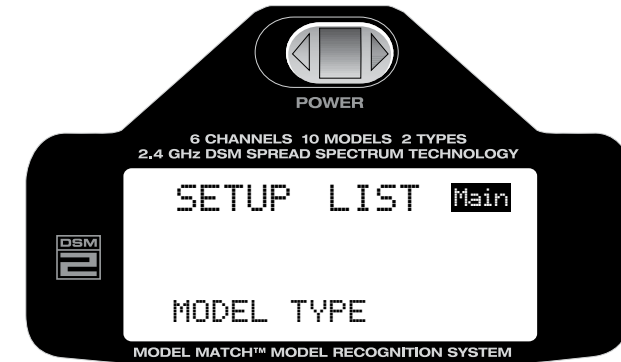

Alternatively the setup list can be accessed from the main screen by pressing the roller to access the ADJUST LIST, then scrolling through the ADJUST LIST by rolling the roller to highlight SETUP LIST, then pressing the roller.

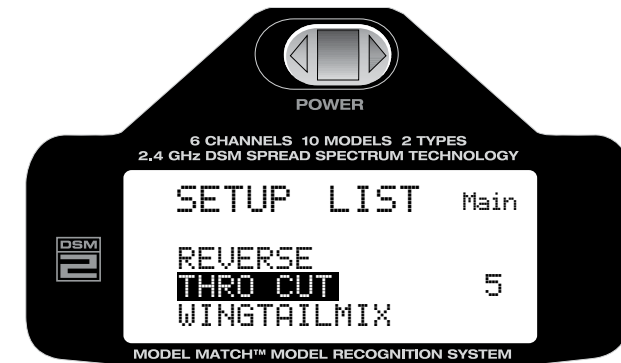

Rotate the roller to highlight THRO CUT then press the roller to access the Throttle Cut function.



TO PROGRAM A THROTTLE CUT

Rotate the roller to highlight INH then press the roller to highlight INH. Now rotate the roller to ACT or INH the Throttle Cut function.

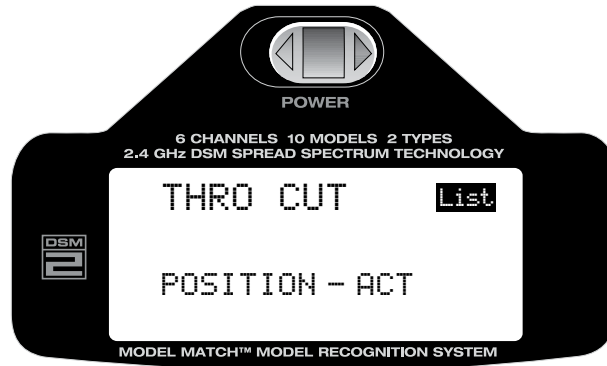

TO RETURN TO THE MAIN SCREEN

Press and hold the roller for more than 3 seconds then release the roller and the system will return to the main screen.

TO RETURN TO THE SETUP LIST

Rotate the roller to highlight LIST in the upper right corner then pressing the roller will return the system to the SETUP LIST screen.

WING TAIL MIX

The DX6i offers three different wing types to choose from: Normal, Dual aileron and Elevon (also called Delta mixing). In addition, V-Tail mixing is available from this screen.

NORMAL

When the DUALAILE and ELEVON wing function are INH, Normal wing type is selected. Use this wing type with common aircraft that utilize only one servo for both ailerons. Normal is the default setting.

When the V-tail function is INH, normal tail function (separate elevator and rudder) is selected.

DUAL AILERON WING TYPE SELECTION

Dual Ailerons require the use of one servo for each aileron and allow the use of ailerons as flaps or spoilers. This function also allows the precise independent adjustment of up and down travel, and independent sub-trim and differential of each aileron.

V-TAIL SELECTION

V-tail combines the elevator and rudder channel to provide pitch and yaw control when using a V-tail equipped airplane. This function also allows the precise independent adjustment of up and down travel, and independent sub-trim and dual rate adjustments of the V-tail's control surfaces.

ELEVON WING TYPE SELECTION

Elevon wing arrangements combine the function of ailerons with the function of the elevator to allow precise control of both roll and pitch.

TO ENTER THE WING TAIL MIX FUNCTION

Press the ROLLER and hold while turning on the transmitter. When SETUP LIST appears on screen release the roller.

Alternatively the setup list can be accessed from the main screen by pressing the roller to access the ADJUST LIST, then scrolling through the ADJUST LIST by rolling the roller to highlight SETUP LIST, then pressing the roller.

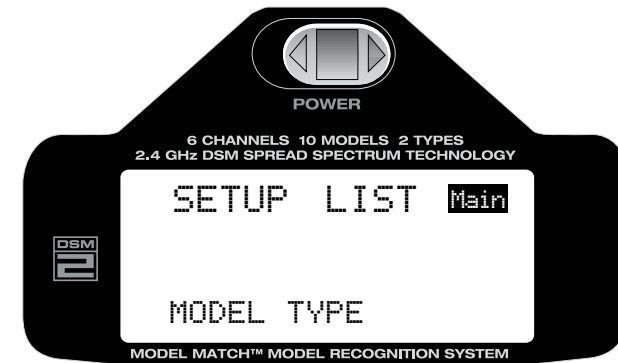

Rotate the roller to highlight WINGTAILMIX then press the roller to access the Wing tail mix function.



TO SELECT A WING/TAIL TYPE

Rotate the roller to highlight the desired wing or tail type then press the roller to highlight the desired function. Rotate the roller to inhibit (INH) or activate (ACT) the function.

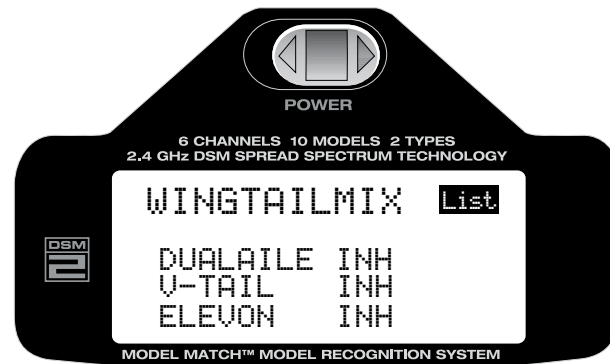

Note: When Flaperon or Delta Wing type is selected, the travel adjustment is used to adjust the individual servo throw, while the combined aileron travel is adjusted with the aileron dual rate. It is also possible to set aileron differential. Reverse switches are applicable for each servo. Neutral adjustments of each servo are made by the Sub Trim Function.

DUAL AILERON WING TYPE SERVO CONNECTIONS

- AILE servo port (right aileron)
- AUX1 servo port (left aileron)

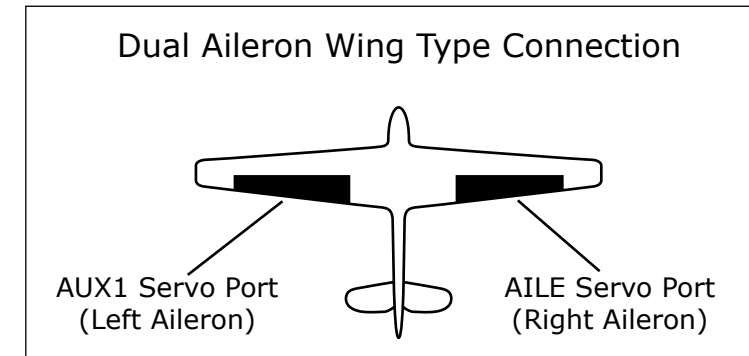

- RUDD servo port (right V-tail)
- ELEV servo port (left V-tail)

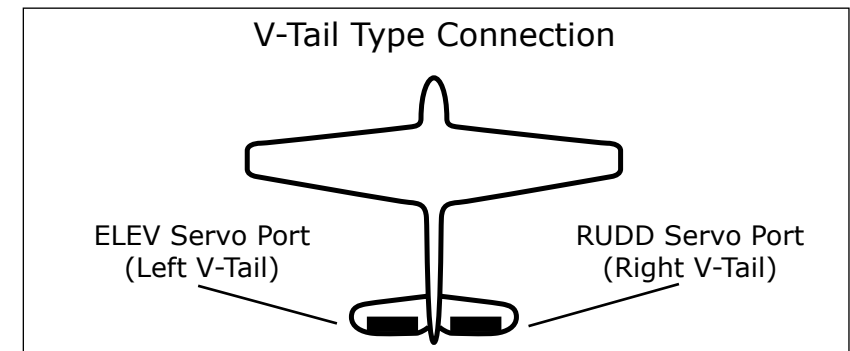

- ELEV servo port (right aileron)
- AILE servo port (left aileron)

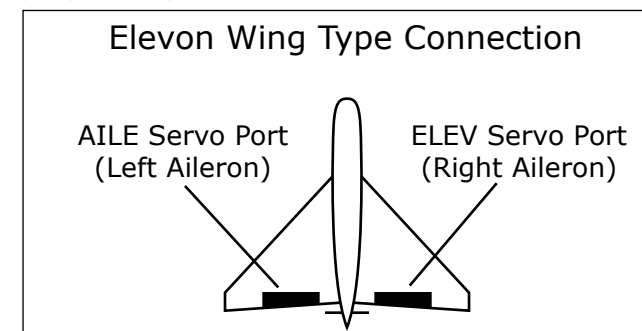

TO RETURN TO THE MAIN SCREEN

Press and hold the roller for more than 3 seconds then release the roller and the system will return to the main screen.

TO RETURN TO THE SETUP LIST

Rotate the roller to highlight LIST in the upper right corner then pressing the roller will return the system to the SETUP LIST screen.

D/R COMBI SWITCH ASSIGNMENT

The Dual Rate Combi switch assignment function allows the aileron, elevator and rudder dual rate and exponential functions to be assigned to one of four common switches such that the dual rates/expos for all three channels can be accessed using a single switch.

TO ACCESS DUAL RATE COMBI ASSIGNMENT

To access the dual rate combi function rotate the roller to highlight D/R COMBI then press the roller to access the Dual Rate Combi function.

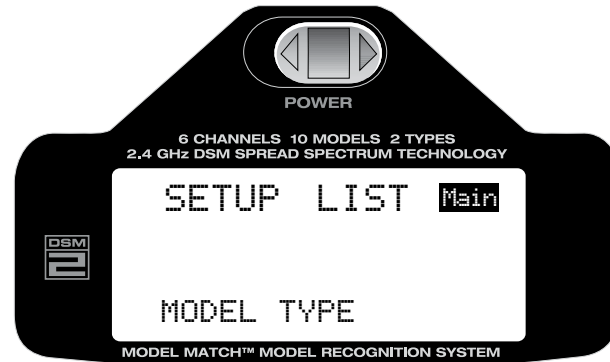

Rotate the roller to highlight INH then press the roller. Now rotate the roller to select AILE, ELEV, RUDD or GEAR.

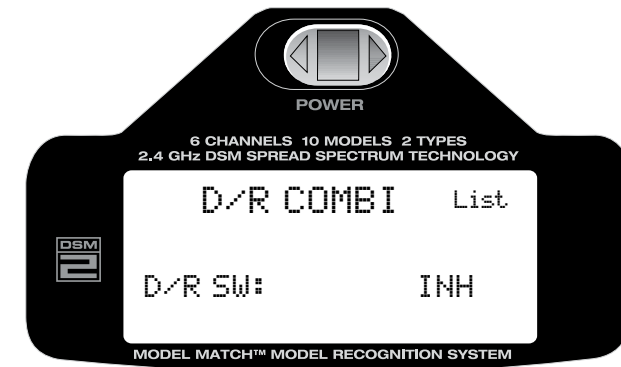

TO RETURN TO THE MAIN SCREEN

Press and hold the roller for more than 3 seconds then release the roller and the system will return to the main screen.

TO RETURN TO THE SETUP LIST

Rotate the roller to highlight LIST in the upper right corner then pressing the roller will return the system to the SETUP LIST screen.

Note: If INH is selected the aileron, elevator and rudder dual rate and expo functions independently operate using their respective switches.

TIMER

The DX6i features an on screen timer with two programming options:

DOWN-TIMER:

Down Timer - The countdown timer allows a preset time in ten-second intervals up to 59 minutes and 50 seconds to be programmed, and when that time expires, a beeper will sound five (5) beeps every five (5) seconds.

UP-TIMER:

Up Timer - The up timer function is a simple count-up timer that displays minutes and seconds up to 59 minutes and 59 seconds. The start time can be programmed. In most cases the default start setting of 00:00 is recommended.

When the DOWN-TIMER or UP-TIMER function is selected, the timer will be displayed on the main screen. The following buttons are used in conjunction to operate the timer function:

Trainer Timer button- when programmed Used to stop start and reset the timer.

Throttle Cut button- when programmed Used to start stop and reset the timer.

Note: To reset the timer press and hold the assigned timer switch (throttle cut or trainer) for more than 3 seconds.

TO SELECT THE TIMER FUNCTION

Press the ROLLER and hold while turning on the transmitter. When SETUP LIST appears on screen release the roller.

Alternatively the setup list can be accessed from the main screen by pressing the roller to access the ADJUST LIST then scrolling through the ADJUST LIST by rolling the roller to highlight SETUP LIST then press the roller.

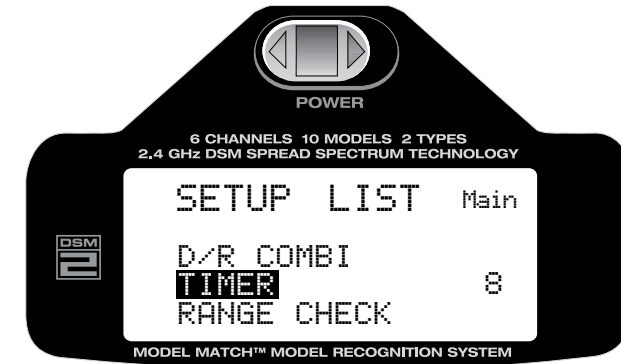
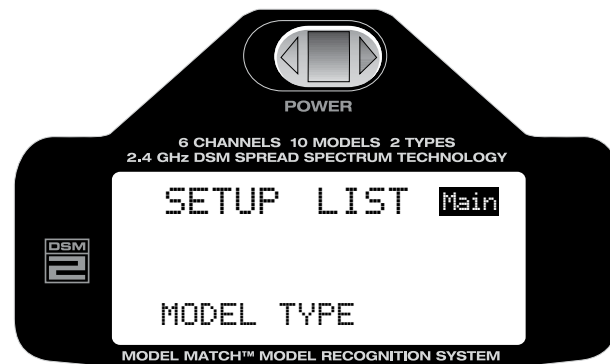

Rotate the roller to highlight TIMER then press the roller to access the Timer function.

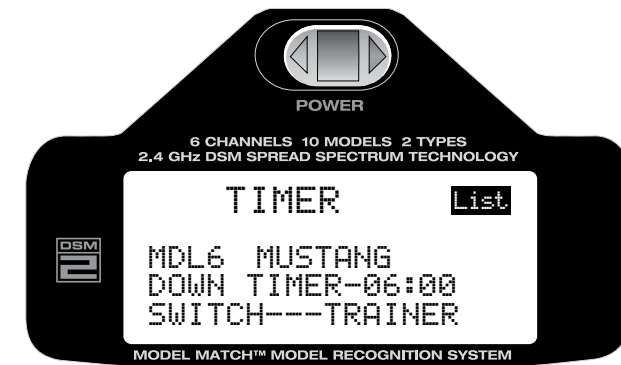

TO PROGRAM THE TIMER FUNCTION

Rotate the roller to highlight the desired timer function that you wish to change.

UP/ Down- selects the up or down timer function

TIME- in minutes or seconds

Switch Options- Trainer or Throttle Cut

When the desired function is highlighted press the roller to access the function.

Rotate the roller to change the option or value.

TO RETURN TO THE MAIN SCREEN

Press and hold the roller for more than 3 seconds then release the roller and the system will return to the main screen.

TO RETURN TO THE SETUP LIST

Rotate the roller to highlight LIST in the upper right corner then pressing the roller will return the system to the SETUP LIST screen.

RANGE CHECK

RANGE CHECK: When activated the Range Check screen allows for a range check by using the trainer switch to reduce the output power.

TO ENTER THE RANGE CHECK FUNCTION

Press the ROLLER and hold while turning on the transmitter. When SETUP LIST appears on screen release the roller.

Alternatively the setup list can be accessed from the main screen by pressing the roller to access the ADJUST LIST, then scrolling through the ADJUST LIST by rolling the roller to highlight SETUP LIST, then pressing the roller.

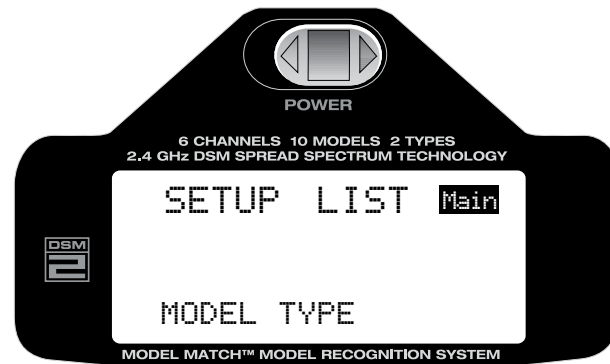

Rotate the roller to highlight RANGE CHECK then press the roller to access the RANGE CHECK function.

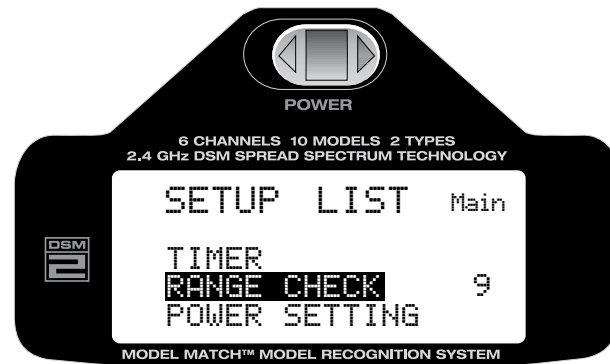

RANGE CHECKING A MODEL

Rotate the roller to highlight RANGE and press the roller to access the range function.

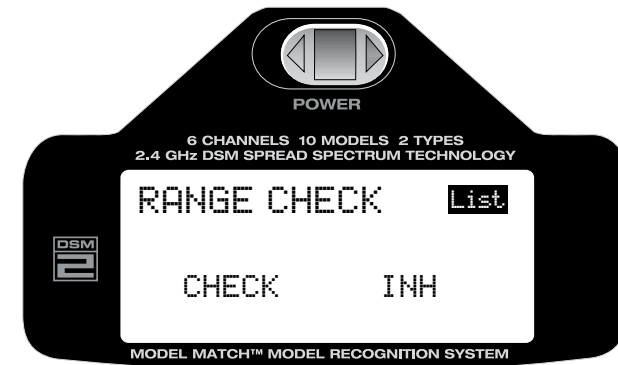

HOW TO RANGE TEST THE DX6I



RANGE TESTING THE DX6I

1. With the model on and resting on the ground, stand 30 paces (approx. 90 feet) away from the model.
2. Face the model with the transmitter in your normal flying position. Place the transmitter in the range test screen (see above) and pull and hold the trainer switch on the top of the transmitter. This causes reduced power output from the transmitter.
3. You should have total control of the model with the button depressed at 30 paces (90 feet).

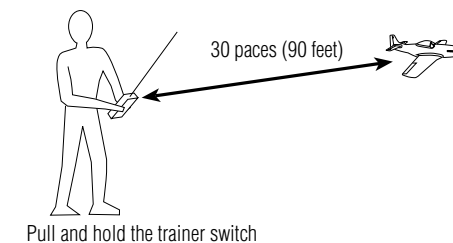

4. If control issues exist, call the Horizon Product Support Team at 1-877-504-0233 for further assistance.

POWER SETTING

The power setting screen is used to place the transmitter in one of two power settings. A-EU 328 is appropriate for most European countries conforming to EU 300-328, while B-US 247 should be selected for use in the United States and countries outside the EU.

TO ENTER THE POWER SETTING FUNCTION

Press the ROLLER and hold while turning on the transmitter. When SETUP LIST appears on screen release the roller.

Alternatively the setup list can be accessed from the main screen by pressing the roller to access the ADJUST LIST, then scrolling through the ADJUST LIST by rolling the roller to highlight POWER SETTING, then press the roller to access the POWER setting function.

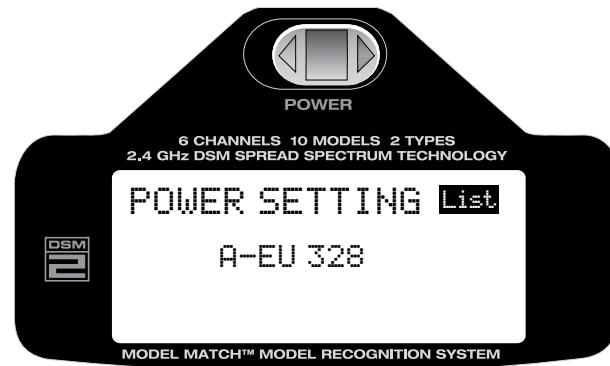
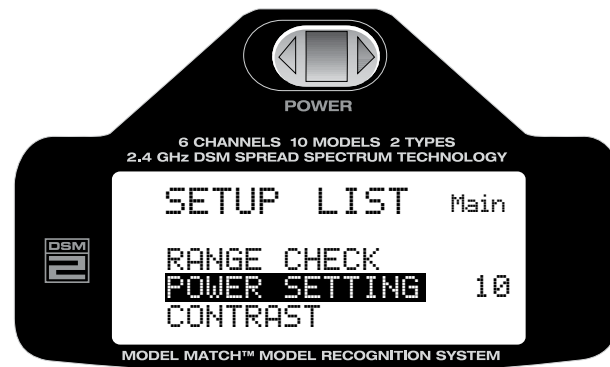

Rotate the roller to highlight the power setting then press the roller. Now rotate the roller to select A-EU 328 for EU countries outside of the US and B-US 247 if the system is to be used in the USA and in non EU countries.

TO RETURN TO THE MAIN SCREEN

Press and hold the roller for more than 3 seconds then release the roller and the system will return to the main screen.

TO RETURN TO THE SETUP LIST

Rotate the roller to highlight LIST in the upper right corner then pressing the roller will return the system to the SETUP LIST screen.

RF MODE

Std is the standard RF mode. FR is the France RF mode and should only be selected if the transmitter is used in France.

CONTRAST

The contrast function allows the adjustment of the screen contrast.

TO ACCESS THE CONTRAST SCREEN

Press the ROLLER and hold while turning on the transmitter. When SETUP LIST appears on screen release the roller.

Alternatively the setup list can be accessed from the main screen by pressing the roller to access the ADJUST LIST, then scrolling through the ADJUST LIST by rolling the roller to highlight SETUP LIST, then pressing the roller.

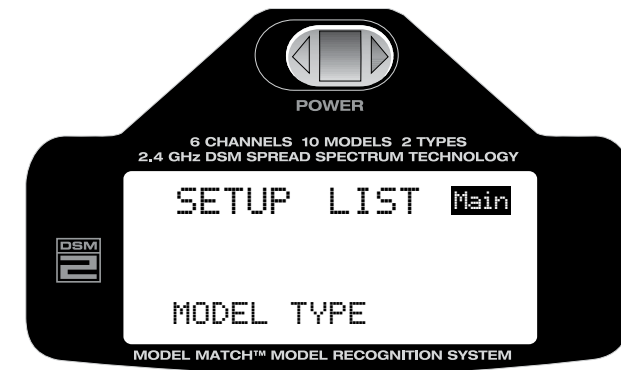

Rotate the roller to highlight CONTRAST then press the roller to access the contrast function.

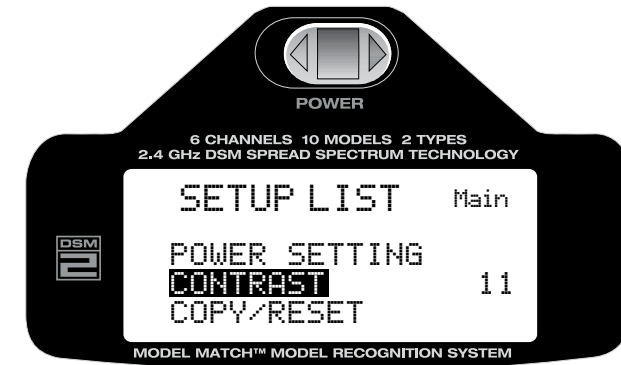

CONTRAST: Allows the adjustment of the screen contrast from 0 to 100%.

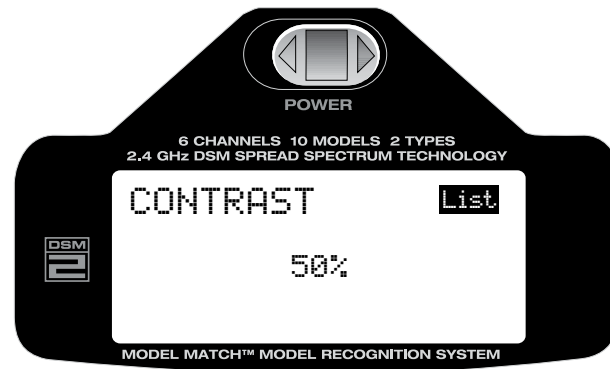

Rotate the roller to adjust the screen contrast from 0 to 100%.

TO RETURN TO THE MAIN SCREEN

Press and hold the roller for more than 3 seconds then release the roller and the system will return to the main screen.

TO RETURN TO THE SETUP LIST

Rotate the roller to highlight LIST in the upper right corner then pressing the roller will return the system to the SETUP LIST screen.

COPY/RESET

The COPY function allows the current model memory that is being used to be transferred to any of the other 9 available model memories. This is useful when experimenting with different model setups.

The Model Reset function allows the model memory of the current model to be reset to the factory default setting.

TO ENTER THE COPY/RESET FUNCTION

Press the ROLLER and hold while turning on the transmitter. When SETUP LIST appears on screen release the roller.

Alternatively the setup list can be accessed from the main screen by pressing the roller to access the ADJUST LIST, then scrolling through the ADJUST LIST by rolling the roller to highlight SETUP LIST, then pressing the roller.

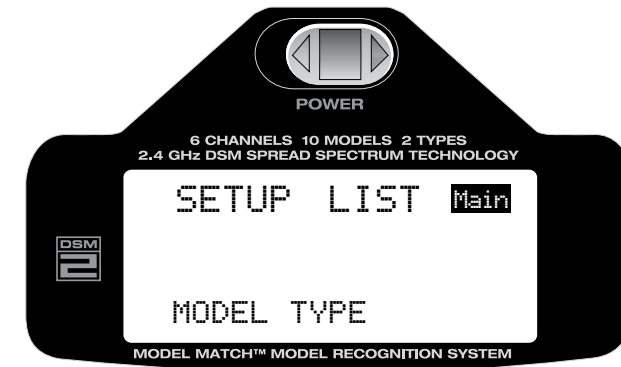

Rotate the roller to highlight COPY/RESET then press the roller to access the COPY/RESET function.

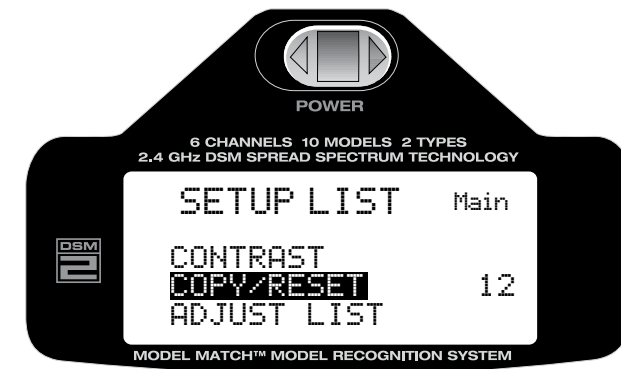

TO ACCESS THE COPY FUNCTION

Rotate the roller to highlight COPY then press the roller to enter the COPY function.

COPY SCREEN

Rotate the roller to COPY and select the model memory that you wish to copy by pressing and rotating the roller.

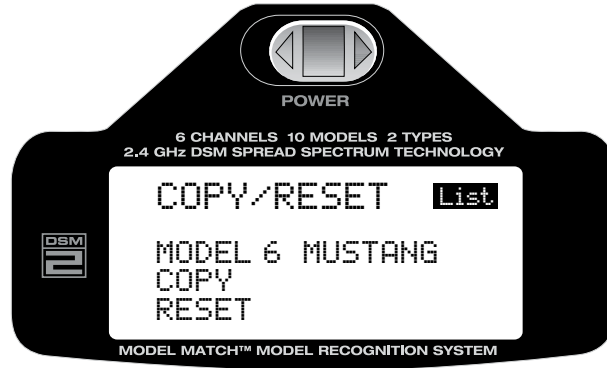

When the desired model memory is selected, press the roller to highlight YES, next to SURE, and then press the roller to copy the model to the selected memory.

Note: Be aware that the model you copy to will have its memory replaced with the new model's memory, and the programming information for the model to be copied to will be erased.

TO RETURN TO THE MAIN SCREEN

Press and hold the roller for more than 3 seconds then release the roller and the system will return to the main screen.

TO RETURN TO THE SETUP LIST

Rotate the roller to highlight LIST in the upper right corner then pressing the roller will return the system to the SETUP LIST screen.

TO PERFORM A RESET

Press the ROLLER and hold while turning on the transmitter to enter the SETUP LIST. When SETUP LIST appears on screen release the roller.

Alternatively the setup list can be accessed from the main screen by pressing the roller to access the ADJUST LIST then scrolling through the ADJUST LIST by rolling the roller to highlight SETUP LIST then press the roller.

SETUP LIST SCREEN

Rotate the roller to highlight COPY/RESET then press the roller to access the COPY/RESET function.

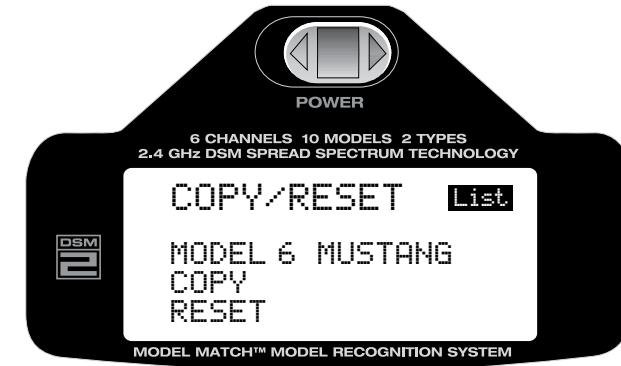

TO ACCESS THE RESET FUNCTION

Rotate the roller to highlight RESET then press the roller to enter the RESET function.

RESET SCREEN

Rotate the roller to YES, next to SURE, and then press the roller to reset the model to factory default settings.

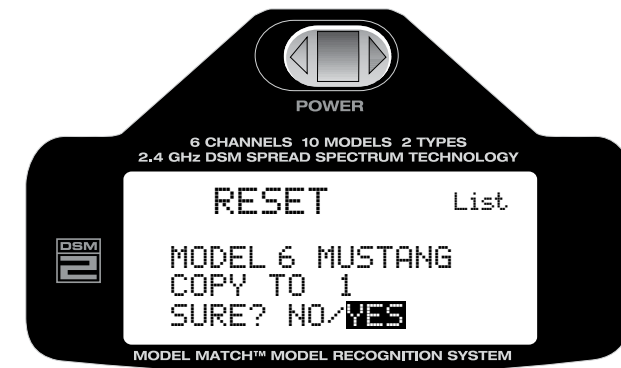

TO RETURN TO THE MAIN SCREEN

Press and hold the roller for more than 3 seconds then release the roller and the system will return to the main screen.

TO RETURN TO THE SETUP LIST

Rotate the roller to highlight LIST in the upper right corner, then pressing the roller will return the system to the SETUP LIST screen.

ADJUST LIST

The adjust list contains programming features that are commonly used to adjust flight characteristics. These functions included dual rate and expo, travel adjust, mixes, etc. The adjust list is accessible from the main screen by simply pressing the roller or is available through the SETUP LIST.



Model Select (Page 60)

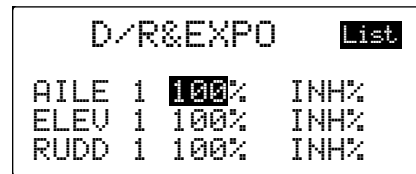

Dual Rate and Exponential (Page 62)

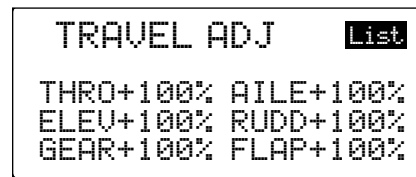

Travel Adjust (Page 64)

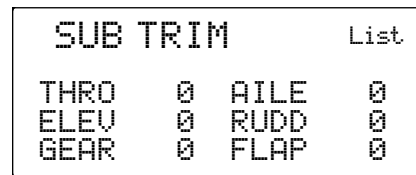

Sub Trim (Page 66)

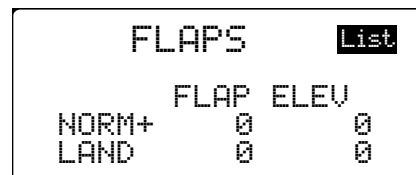

Flaps (Page 68)

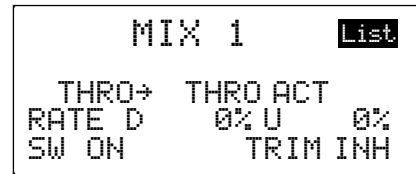

Mix 1 (Page 70)

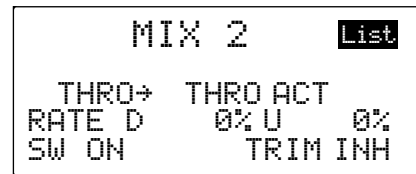

Mix 2 (Page 70)

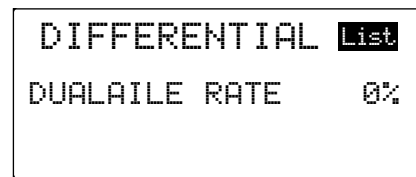

Differential (Page 75)

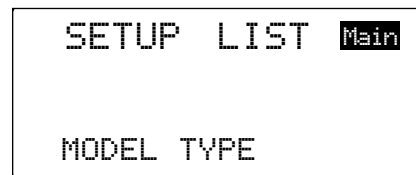

Setup List (Page 31)

ADJUST LIST includes programming functions that are frequently used to select or adjust the model.

TO ACCESS THE ADJUST LIST

With the transmitter already powered on and the main screen displayed, press and release the ROLLER to enter the ADJUST LIST.

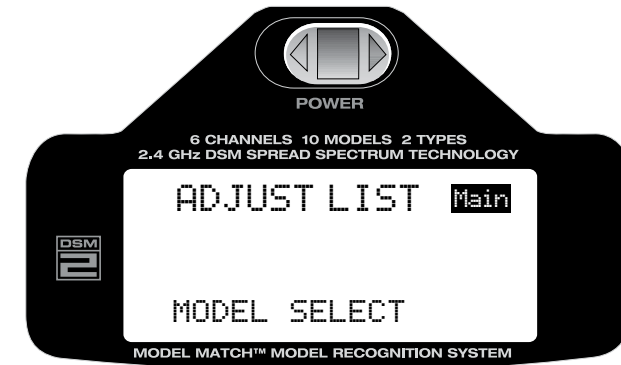

TO EXIT THE ADJUST LIST

Press and hold the roller for more than 3 seconds then release the roller and the system will return to the main screen.

Alternatively use the roller to highlight MAIN. Pressing the roller will return to the MAIN screen.

MODEL SELECT

The DX6i features a memory function that stores the programmed data for up to 10 models. Any combination of up to 10 airplanes and/or helicopters can be stored in memory. A model name feature with up to eight characters allows each model to be easily identified. (See page 35)

TO ENTER THE MODEL SELECT FUNCTION

With the transmitter already powered on and the main screen displayed, press and release the ROLLER to enter the ADJUST LIST.

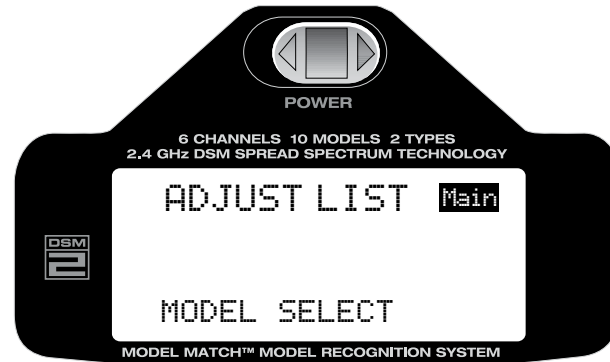

Rotate the ROLLER to the right until MODEL SELECT is highlighted on screen.

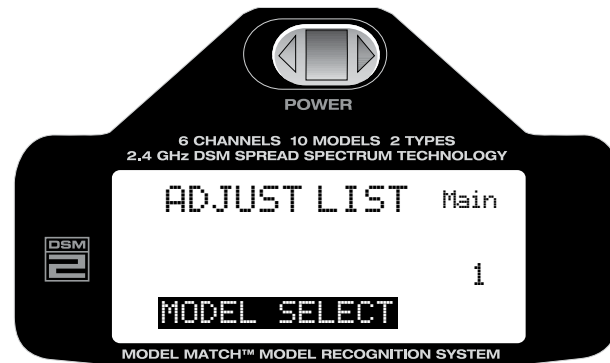

Press the roller to access the Model Select function.

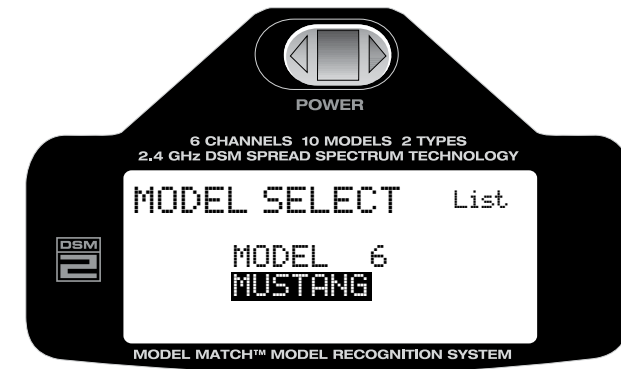

Rotate the roller to display the desired model that you wish to select. Ten models are available.

When the desired model is displayed press the roller to select the displayed model memory. DOWNLOAD... will appear for several seconds and the transmitter will beep indicating the model has been changed.

TO RETURN TO THE MAIN SCREEN

Press and hold the roller for more than 3 seconds then release the roller and the system will return to the main screen.

Alternatively highlighting MAIN with the roller and pressing the roller will return to the MAIN screen.

Turning the transmitter off then back on will also return to the main screen.

MODELMATCH

The DX6i features patented ModelMatch™ technology that prevents operating a model using the wrong memory. This feature can prevent stripped servo gears, broken linkages and even a crash due to trying to operate/ fly a model using the wrong memory.

HOW MODELMATCH WORKS

Each individual model memory has its own embedded code that is transferred to the receiver during binding. The receiver actually learns the code for the specific model memory that has been selected during binding and, when bound, will only operate when that model memory is selected. If a different (non-matching) model memory is selected, the receiver simply won't connect. This feature prevents trying to operate/ fly a model using the wrong model memory. The receiver can be re-programmed to operate with any other model memory by simply re-binding with the transmitter programmed to the desired model memory.

Note: If the receiver is turned on and the matching model memory is not selected, the system will not connect. Either select the matching model memory or rebind the receiver in the current model memory to resume operation.

DUAL RATE AND EXPONENTIAL

The Dual Rate and Exponential function allows two control rates to be programmed and selected with a switch. Dual rates and Expos are available on the aileron, elevator and rudder channels. Changing the dual rate value not only affects the maximum control authority but also affects the overall sensitivity of control. A higher rate yields a higher overall sensitivity. The sensitivity around center can be tailored using the Exponential function to precisely adjust control feel.

Dual and Expo rates can be controlled by their respective dual rate switches (aileron, elevator and rudder) or by one common switch (Aileron D/R, Elevator D/R, Rudder D/R or the Gear switch). See COMBI SWITCH screen on page 46 for detail on combining the Dual rate switches.

Dual rate values are adjustable from 0–100%. The factory default settings for both the 0 and 1 switch positions are 100%. Exponential values are adjustable from -100% to +100% with a factory default of 0% or inhibit. Either switch position may be selected as the low or high rate by placing the switch in the desired position and adjusting the value accordingly.

Note: A negative (-) Expo value will increase sensitivity around neutral, and a positive (+) Expo value will decrease sensitivity around neutral. Normally a positive value is used to desensitize control response around neutral.

TO ADJUST THE DUAL AND EXPO RATES

With the transmitter already powered on and the main screen displayed, press and release the ROLLER to enter the ADJUST LIST.

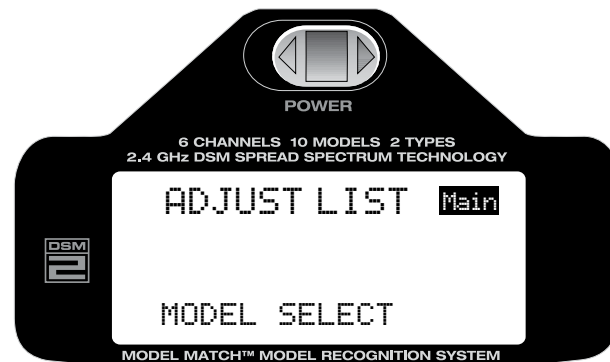

Rotate the ROLLER to the right until D/R&EXPO is highlighted on screen.

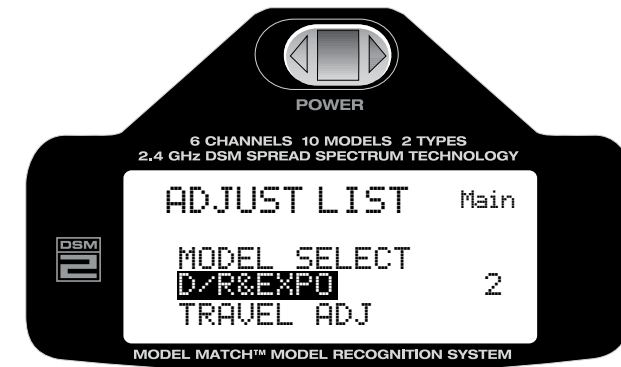

Press the roller to access the Dual Rate and Expo function.

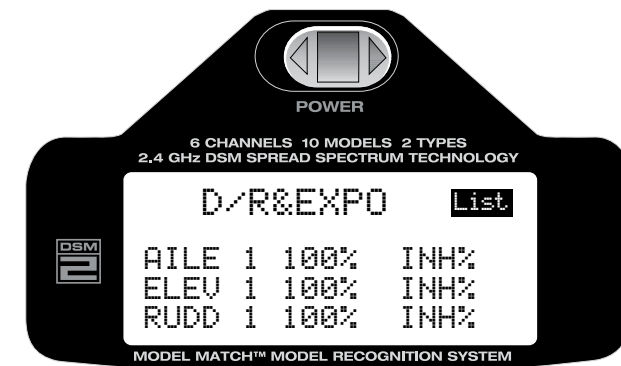

Move the respective D/R switch in the desired position (0 or 1) that you wish to change.

Rotate the roller to highlight the desired channel's EXPO or D/R value that you wish to adjust.

Press the roller to access the D/R or EXPO value.

Rotate the roller to adjust the D/R or Expo value.

After the desired value is programmed press the roller to deselect the value.

TO RETURN TO THE MAIN SCREEN

Press and hold the roller for more than 3 seconds then release the roller and the system will return to the main screen.

TO RETURN TO THE ADJUST LIST SCREEN

Rotate the roller to highlight LIST then press the roller.

The Dual Rate and Expo functions for aileron, elevator and rudder can be combined on a single switch conveniently allowing high or low rates to be selected via one switch. The choices for this are found on the COMBI SWITCH on page 46.

TRAVEL ADJUST

The Travel Adjust function allows the precise end-point adjustments of all six channels in each direction independently. The travel adjust range is from 0–125%.

Channels available for programming are:

- THRO: Throttle
- AILE: Aileron
- ELEV: Elevator
- RUDD: Rudder
- GEAR: Retractable Landing Gear
- FLAP: Flap

TO ACCESS THE TRAVEL ADJUST FUNCTION

With the transmitter already powered on and the main screen displayed, press and release the ROLLER to enter the ADJUST LIST.

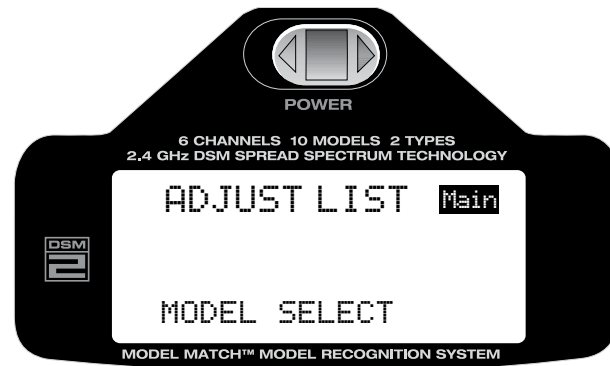

Rotate the ROLLER to the right until TRAVEL ADJ is highlighted on screen.



Press the roller to access the TRAVEL ADJ function.

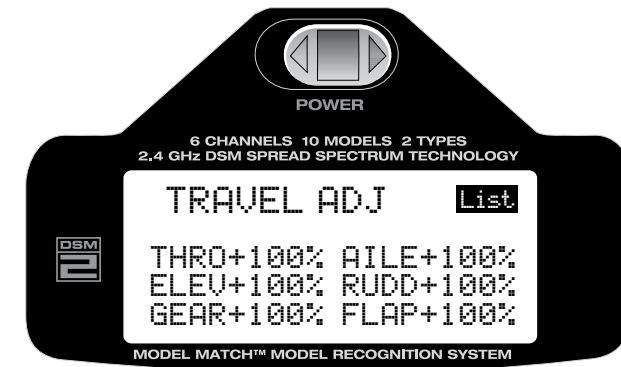

Move the respective stick or switch in the desired direction that you wish to change the travel adjust.

Rotate the roller to highlight the desired channel's value that you wish to adjust.

Press the roller to access the travel adjust value.

Rotate the roller to adjust the travel adjust value.

After the desired value is programmed press the roller to deselect the value.

TO RETURN TO THE MAIN SCREEN

Press and hold the roller for more than 3 seconds then release the roller and the system will return to the main screen.

TO RETURN TO THE ADJUST LIST SCREEN

Rotate the roller to highlight LIST then press the roller.

SUB-TRIM

The Sub-Trim function allows you to electronically adjust the centering of each servo. Sub trim is individually adjustable for all six channels, with a range of + or - 100% (+ or - 30 degrees servo travel).

Caution: Do not use excessive sub-trim values as it is possible to overdrive the servo's maximum travel.

The channels available are:

- THRO: Throttle
- AILE: Aileron
- ELEV: Elevator
- RUDD: Rudder
- GEAR: Retractable Landing Gear
- FLAP: Flap

TO ACCESS THE SUB-TRIM FUNCTION

With the transmitter already powered on and the main screen displayed, press and release the ROLLER to enter the ADJUST LIST.



Rotate the ROLLER to the right until SUB TRIM is highlighted on screen.



Press the roller to access the SUB TRIM function.

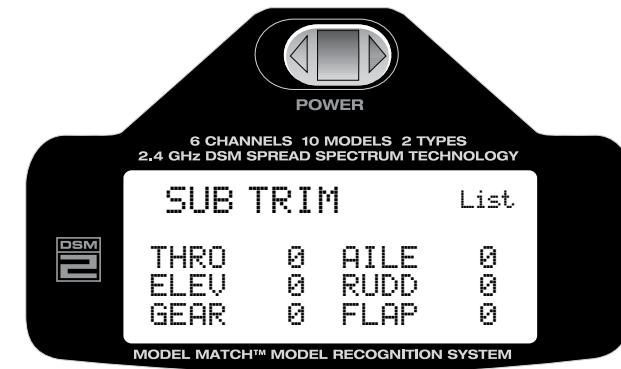

Rotate the roller to highlight the desired channel's value that you wish to adjust.

Press the roller to access the sub trim value.

Rotate the roller to adjust the sub trim value.

After the desired value is programmed press the roller to deselect the value.

TO RETURN TO THE MAIN SCREEN

Press and hold the roller for more than 3 seconds then release the roller and the system will return to the main screen.

TO RETURN TO THE ADJUST LIST SCREEN

Rotate the roller to highlight LIST then press the roller.

FLAP

The Flap System allows the flap and elevator positions to be programmed for landing and takeoff. This is accomplished by selecting values for the elevator and flaps to be activated when the Flap/ Gyro is engaged. Two flap and elevator positions are available. Normal and Land.

To access the FLAPS function

Press the ROLLER and hold while turning on the transmitter. When SETUP LIST appears on screen, release the roller.

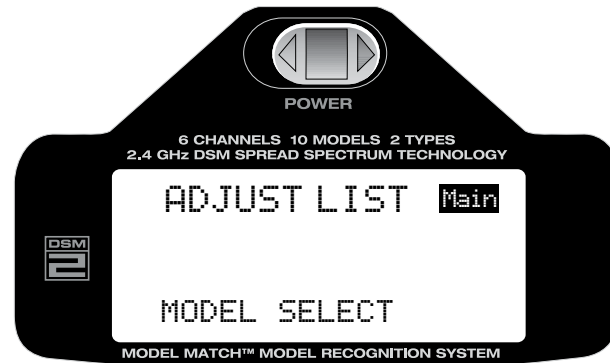

Alternately the setup screen can be accessed from the main screen by pressing the roller to access the ADJUST LIST list then scrolling through the ADJUST LIST using the roller to highlight SETUP LIST, then pressing the roller.



Rotate the roller to highlight FLAPS and press the roller to access the FLAPS function.

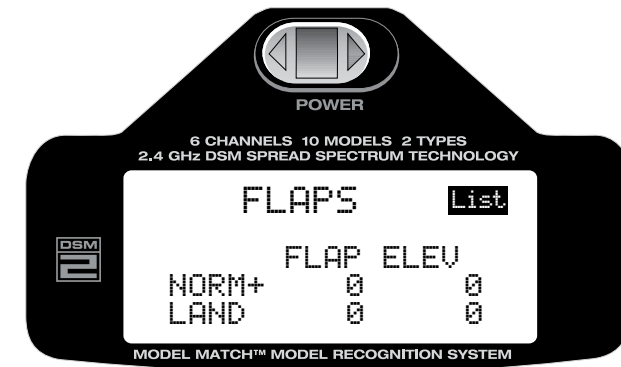

Rotate the roller to highlight the desired flap or elevator value that you wish to adjust then press the roller to access the selected value. Rotate the roller to change the value.

TO RETURN TO THE MAIN SCREEN

Press and hold the roller for more than 3 seconds then release the roller and the system will return to the main screen.

TO RETURN TO THE ADJUST LIST SCREEN

Rotate the roller to highlight LIST then press the roller.

PROGRAMMABLE MIXING 1 AND 2

The DX6i offers two programmable mixes that allow stick or switch inputs to control the output of two or more servos. This function allows mixing any one channel to any other channel, or the ability to mix a channel to itself. The mix can remain ON at all times, or it can be switched OFF in flight, using a number of different switches. Mix values are adjustable from -125% to +125%. Each channel is identified by a four-character name (i.e., Aileron - AILE, Elevator - ELEV, etc.). The channel appearing first is the master channel. The second channel is the slave channel. For example, AILE - RUDD would indicate aileron-to-rudder mixing. Each time the aileron stick is moved, the aileron will deflect, and the rudder will automatically move in the direction and to the position based on the value input in the programmable mix screen. Mixing is proportional, so small inputs of the master channel will produce small outputs of the slave channel. Both mixes offer a trim feature, that when activated, the master channel's trim also affects the slave channel.

ACCESSING PROGRAMMABLE MIX 1 OR MIX 2

With the transmitter already powered on and the main screen displayed, press and release the ROLLER to enter the ADJUST LIST.

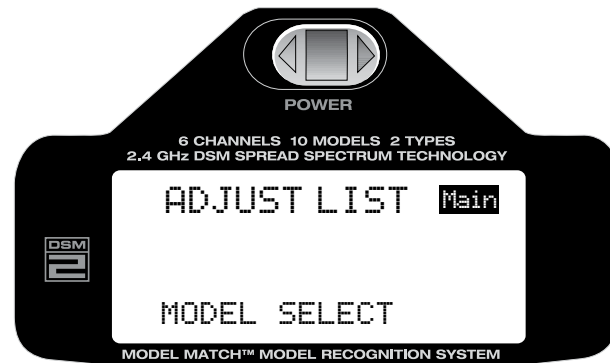

Rotate the ROLLER to the right until MIX 1 is highlighted on screen.



Press the roller to access the MIX 1 function.

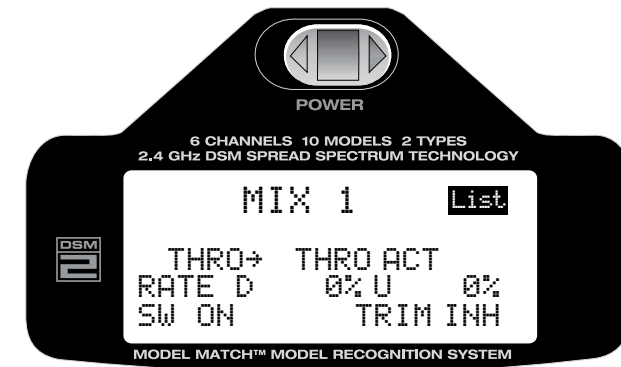

SELECTING MASTER AND SLAVE CHANNELS

Rotate the roller to highlight the master (left) channel in the screen.



Press the roller to access the master channel selection.

Rotate the roller to select the desired master channel.

- THRO: Throttle
- AILE: Aileron
- ELEV: Elevator
- RUDD: Rudder
- GEAR: Retractable Landing Gear
- FLAP: Flap

Press the roller to deselect the master channel then rotate the roller to select the slave channel.

Press the roller to access the slave channel selection.

Rotate the roller to select the desired slave channel.

- THRO: Throttle
- AILE: Aileron
- ELEV: Elevator
- RUDD: Rudder
- GEAR: Retractable Landing Gear
- FLAP: Flap

SELECTING THE MIXING VALUES

Rotate the roller to highlight the desired rate and direction.

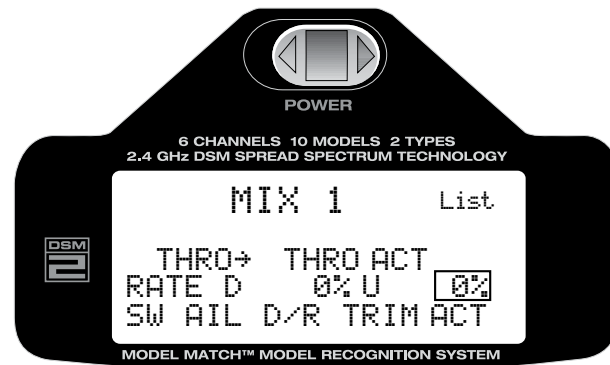

Press the roller to access the rate value.

Using the roller, rotate to adjust the desired mixing values. Note that positive (+) and negative (-) values are available and affect the direction of the slave servo travel.

After the desired value is programmed press the roller to deselect the value.

SWITCH FUNCTIONS

The Mixes can be turned off and on using one of the following switches:

- | | |
|----------|------------------------------|
| ON- | Always on |
| GEAR- | Gear switch forward |
| FLAP- | Flap switch down |
| AIL D/R- | Aileron Dual Rate switch up |
| ELE D/R- | Elevator Dual Fate switch up |
| MIX- | Mix switch forward |

TO PROGRAM THE MIX SWITCH

Rotate the roller to highlight SW.

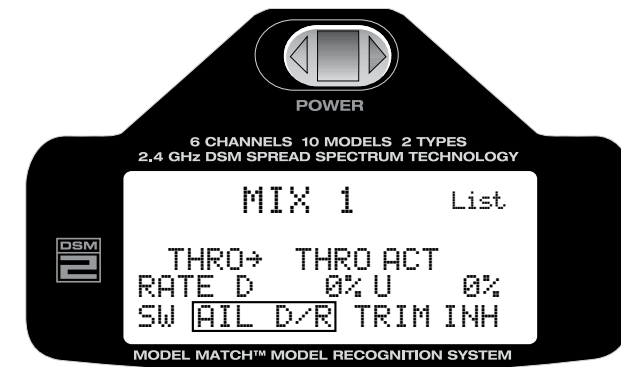

Press the roller to access the switch selection function.

Rotate the roller to select the desired switch.

After the desired switch is programmed press the roller to deselect the value.

TRIM INCLUDE FUNCTION

Both mixes offer a trim feature that, when activated, cause the master channel's trim to also affect the slave channel.

TO PROGRAM THE TRIM INCLUDE FUNCTION

Rotate the roller to highlight TRIM.

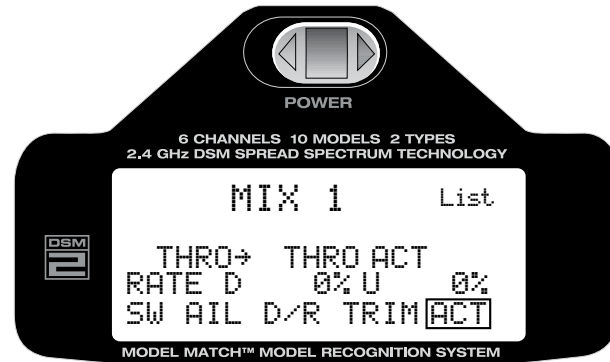

Press the roller to access the trim function.

Rotate the roller to select ACT (activate) or INH (inhibit).

After the trim function is programmed press the roller to deselect the value.

TO RETURN TO THE MAIN SCREEN

Press and hold the roller for more than 3 seconds then release the roller and the system will return to the main screen.

TO RETURN TO THE ADJUST LIST SCREEN

Rotate the roller to highlight LIST then press the roller.

DIFFERENTIAL

Note: Only available when Flaperon or Elevon is activated (see Wing Tail Mix Page 43).

The Differential Aileron function allows precise electronic adjustments of the up vs. down aileron travel of both ailerons. Aileron differential is used to reduce unwanted yaw characteristics during roll inputs. In order to access the Differential Function, flaperon or elevon wing mixing must be selected and two servos must be used to operate the ailerons. Note the Differential range is from 0% to + 100%.

TO ACCESS THE DIFFERENTIAL AILERON MIXING FUNCTION

With the transmitter already powered on and the main screen displayed, press and release the ROLLER to enter the ADJUST LIST.

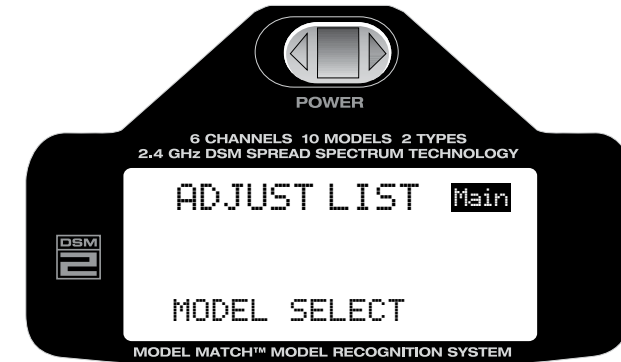

Rotate the ROLLER to the right until DIFFERENTIAL is highlighted on screen.



Press the roller to access the DIFFERENTIAL function.

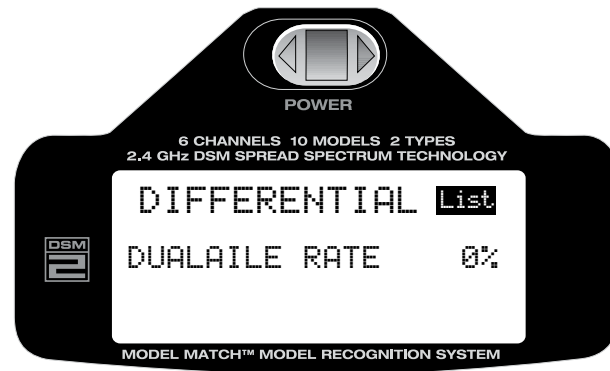

Rotate the roller to highlight the Differential value.

Press the roller to access the Differential value.

Rotate the roller to adjust the Differential value.

After the desired value is programmed press the roller to deselect the value.

TO RETURN TO THE MAIN SCREEN

Press and hold the roller for more than 3 seconds then release the roller and the system will return to the main screen.

TO RETURN TO THE ADJUST LIST SCREEN

Rotate the roller to highlight LIST then press the roller.

HELICOPTER PROGRAMMING GUIDE

TRANSMITTER CONTROL IDENTIFICATION AND LOCATION



GENERAL INFORMATION

THROTTLE ALT

The Throttle ALT function makes the throttle stick trim active only when the throttle stick is at less than half throttle. This allows accurate idle adjustments without affecting the mid to high throttle position.

LOW BATTERY ALARM

When the battery voltage drops below 4.3 volts an alarm will sound and the voltage bar will flash.

WARNING SCREEN FOR THROTTLE HOLD/STUNT MODE

When the DX6i is operated in the helicopter mode, there is a warning system that is employed to avoid hot starts (accidental high throttle startups) when the power switch is initially turned ON. If the flight mode switch or throttle hold is on, an alarm will sound and a warning message will be displayed on the LCD. When all switches are returned to the normal condition, the display will return to normal.

TRAINER

The DX6i offers a Trainer function that allows the transmitter to operate as a master or slave. The trainer switch is located on the back left of the transmitter.

MASTER

The transmitter can be used as a master but the slave transmitter must have the same programming (i.e. reverse, travel adjust, dual rates, mixes, sub trims, etc.) as the master.

SLAVE MODE (CONVENTIONAL)

When using the transmitter as a slave with another DX6i it's necessary to match all the programmable settings (i.e. reverse, travel adjust, etc.).

PROGRAMMING USING THE ROLLER

The roller is used to access all programming functions:

- Pressing and releasing the roller accesses/enters the selected function
- Rolling the roller changed values or selections

TO ACCESS THE MAIN SCREEN:

Anytime the transmitter is turned on the main screen will appear.

TO RETURN TO THE MAIN SCREEN:

From the SETUP LIST or SETUP LIST screens, pressing and holding the roller for more than three seconds then releasing the roller will return the display to the main screen.

TO RETURN TO THE LIST OR SETUP SCREEN:

From any program function screen, pressing and holding the roller for more than three seconds then releasing the roller will return the display to the LIST or SETUP screen.

SETUP LIST

The SETUP list contains the programming functions that are normally only used during the initial setup of the model (i.e. model type, servo reverse, model name).

SETUP LIST includes programming functions that are normally used during setup. System programming functions for helicopters include:

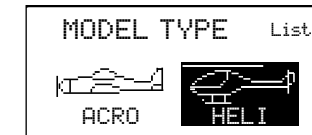

Model Type (Page 81)

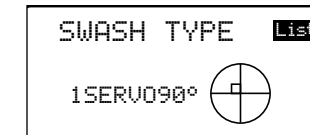

Swashplate Type (Page 89)

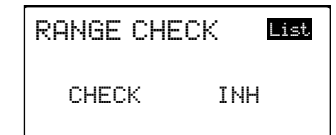

Range Check (Page 97)

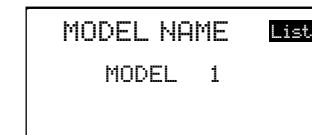

Model Name (Page 83)

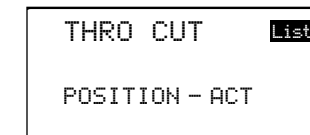

Throttle Cut (Page 91)

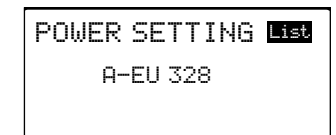

Power Setting (Page 99)

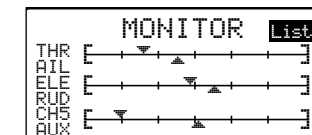

Monitor (Page 85)

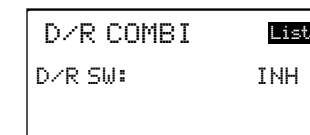

D/R Combi (Page 93)

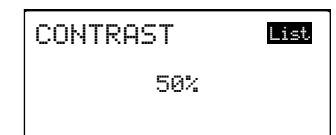

Contrast (Page 100)

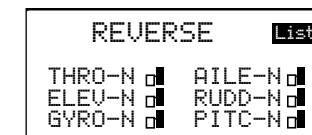

Reverse (Page 87)

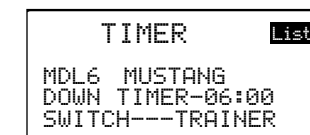

Timer (Page 95)



Copy/Reset (Page 102)

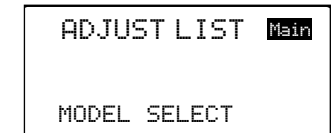

Adjust List (Page 105)

TO ENTER THE SETUP LIST

Press the ROLLER and hold while turning on the transmitter. When SETUP LIST appears on screen, release the roller.

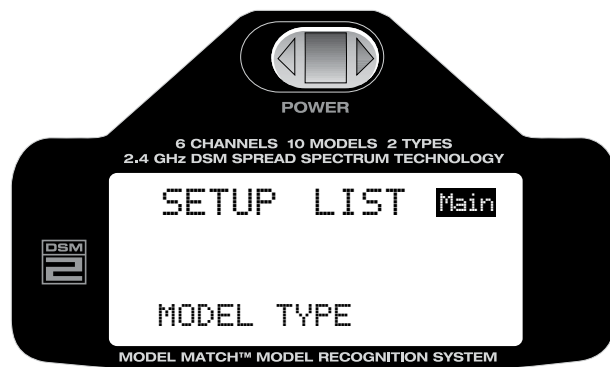

Alternatively the setup list can be accessed from the main screen by pressing the roller to access the ADJUST LIST then scrolling through the ADJUST LIST by rolling the roller to highlight SETUP LIST, then press the roller and the SETUP LIST will appear.

TO EXIT THE SETUP LIST

Press and hold the roller for more than 3 seconds then release the roller and the system will return to the main screen.

Alternatively rotating the roller to highlight MAIN in the upper right corner then pressing the roller will return the system to the main screen.

Turning the transmitter off then back on will return the transmitter to the main screen.

MODEL TYPE FUNCTION

The DX6i features two programming types: Airplane and Helicopter. The DX6i can memorize data for up to 10 models individually and the model type will automatically be stored with each model memory.

TO ENTER THE MODEL TYPE FUNCTION

Press the ROLLER and hold while turning on the transmitter. When SETUP LIST appears on screen, release the roller.

Alternatively the setup list can be accessed from the main screen by pressing the roller to access the ADJUST LIST then scrolling through the ADJUST LIST by rolling the roller to highlight SETUP LIST, then press the roller.

MODEL TYPE appears on the lower section of the screen.

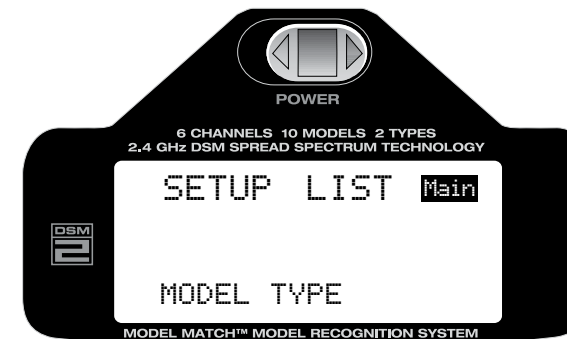

Rotate the roller to highlight MODEL TYPE then press then roller to access the MODEL TYPE function.

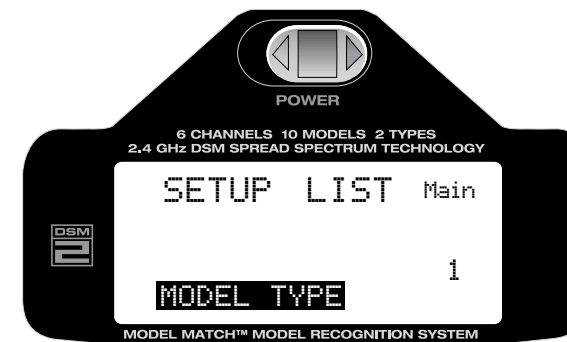

TO SELECT A MODEL TYPE

Rotate the roller to highlight the desired model type ACRO (airplane) or HELI helicopter then press the roller to program that model type in model memory. Note that when changing model type all programming from the previous model will be erased and the new model will be reset to factory default settings.

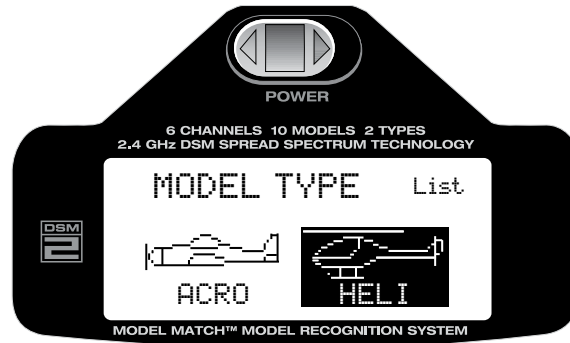

TO RETURN TO THE MAIN SCREEN

Press and hold the roller for more than 3 seconds then release the roller and the system will return to the main screen.

TO RETURN TO THE SETUP LIST

Rotate the roller to highlight LIST in the upper right corner then pressing the roller will return the system to the SETUP LIST screen.

MODEL NAME

The Model Name function is used to input and assign the model's name to a specific memory, allowing easy identification of each model's program. Each model's name is displayed on the main screen when that model is selected. Up to eight characters that include numbers and letters are available.

TO ENTER THE MODEL NAME FUNCTION

Press the ROLLER and hold while turning on the transmitter. When SETUP LIST appears on screen release the roller.

Alternatively the setup list can be accessed from the main screen by pressing the roller to access the ADJUST LIST, then scrolling through the ADJUST LIST by rolling the roller to highlight SETUP LIST, then pressing the roller.

MODEL TYPE appears on the lower section of the screen.

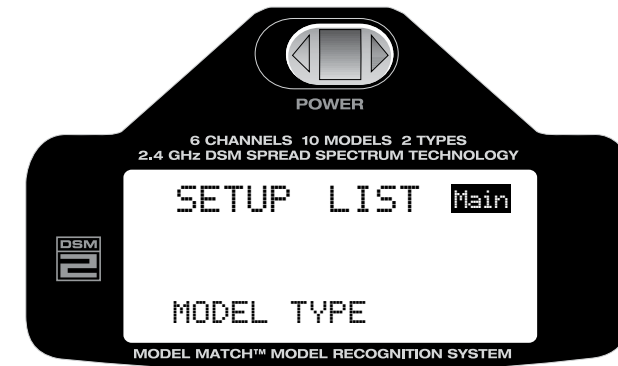

Rotate the roller to highlight MODEL NAME then press the roller to access the MODEL NAME function.

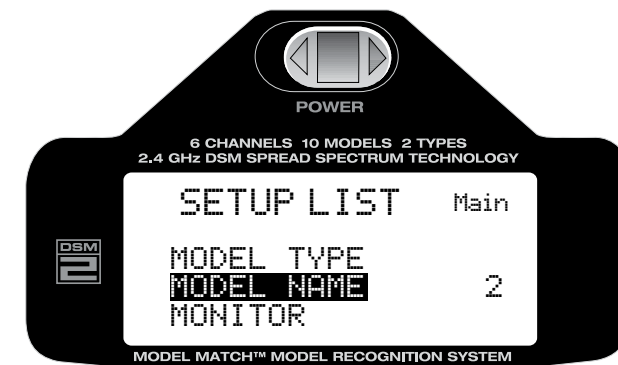

TO PROGRAM A MODEL NAME

Rotate the roller to highlight the block below the MODEL # shown on the screen then press the roller.

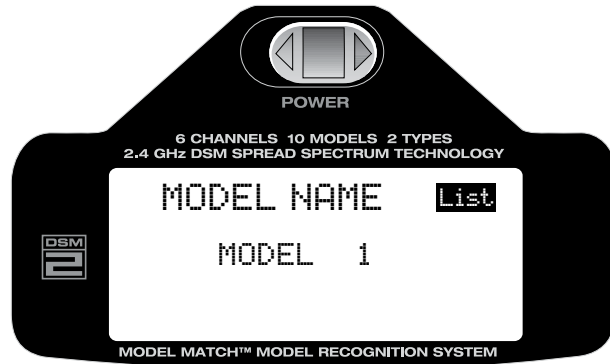

Rotate the roller to select the desired position that you wish to assign a letter or number to then press the roller to access the numbers or letter characters.

Rotate the roller to scroll through the letters/ numbers and when the desired number is selected pressing the roller will assign it to the selected position.

Repeat this process to complete the model name then highlight OK! when finished.

TO RETURN TO THE MAIN SCREEN

Press and hold the roller for more than 3 seconds then release the roller and the system will return to the main screen.

TO RETURN TO THE SETUP LIST

Rotate the roller to highlight LIST in the upper right corner then pressing the roller will return the system to the SETUP LIST screen.

MONITOR

The servo monitor screen serves as a useful tool when programming your radio. It displays servo movement and direction when different programming functions, sticks and/or switches are moved.

TO ACCESS THE MONITOR

Press the ROLLER and hold while turning on the transmitter to enter the SETUP LIST. When SETUP LIST appears on screen release the roller.

Alternatively the setup list can be accessed from the main screen by pressing the roller to access the ADJUST LIST, then scrolling through the ADJUST LIST by rolling the roller to highlight SETUP LIST, then pressing the roller.

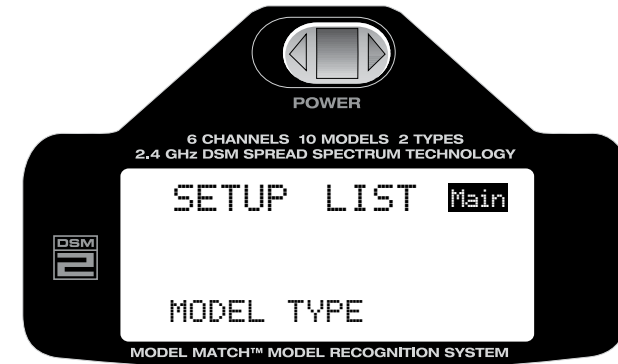

Rotate the ROLLER to the right until SERVO is highlighted on screen.

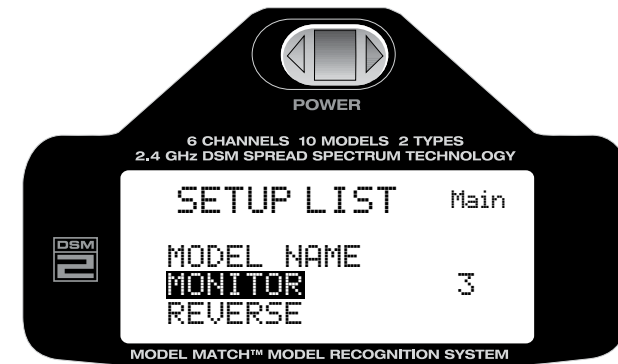

Press the roller to access the Servo monitor screen.

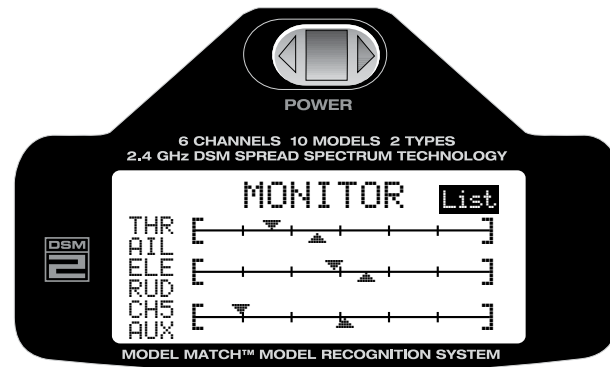

TO RETURN TO THE MAIN SCREEN

Press and hold the roller for more than 3 seconds then release the roller and the system will return to the main screen.

TO RETURN TO THE SETUP LIST

Rotate the roller to highlight LIST in the upper right corner then pressing the roller will return the system to the SETUP LIST screen.

REVERSE

The Reverse Switch function provides an electronic means of reversing the servo throw. Servo reversing is available for all six channels.

TO ACCESS THE REVERSE FUNCTION

Press the ROLLER and hold while turning on the transmitter. When SETUP LIST appears on screen release the roller.

Alternatively the setup list can be accessed from the main screen by pressing the roller to access the ADJUST LIST, then scrolling through the ADJUST LIST by rolling the roller to highlight SETUP LIST, then pressing the roller.

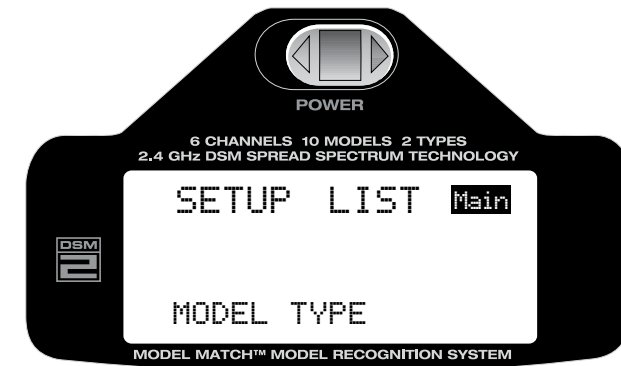

Rotate the roller to highlight REVERSE then press the roller to access the REVERSE function.

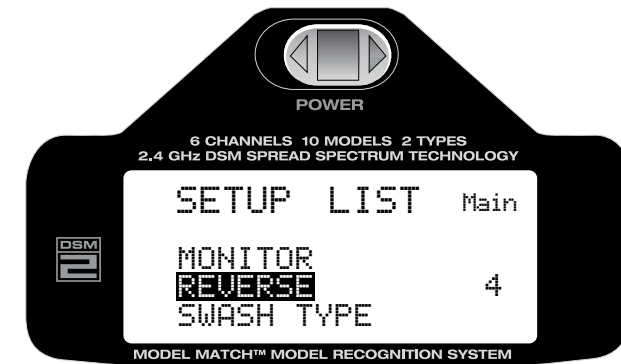

TO REVERSE A CHANNEL

Rotate the roller to highlight the desired channel then press the roller to select that channel.

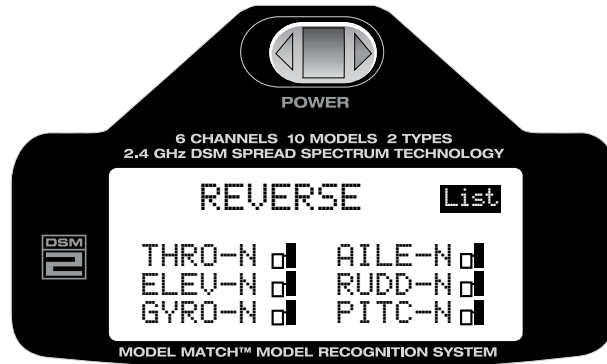

With the desired channel selected rotate the roller to select (N=Normal, R+Reverse).

- THRO: Throttle
- AILE: Aileron
- ELEV: Elevator
- RUDD: Rudder
- GYRO: Gyro
- PITC: Pitch

When the reverse direction is selected press the roller to deselect the channel.

TO RETURN TO THE MAIN SCREEN

Press and hold the roller for more than 3 seconds then release the roller and the system will return to the main screen.

TO RETURN TO THE SETUP LIST

Rotate the roller to highlight LIST in the upper right corner then pressing the roller will return the system to the SETUP LIST screen.

SWASH TYPE

The DX6i offers 2 swashplate types:

One Servo: 90 degrees (standard mechanical mix)

Three Servo: CCPM 120 degrees

Select the swashplate type to match your helicopter.

TO SELECT THE SWASHPLATE TYPE

Press the ROLLER and hold while turning on the transmitter. When SETUP LIST appears on screen release the roller.

Alternatively the setup list can be accessed from the main screen by pressing the roller to access the ADJUST LIST, then scrolling through the ADJUST LIST by rolling the roller to highlight SETUP LIST, then pressing the roller.

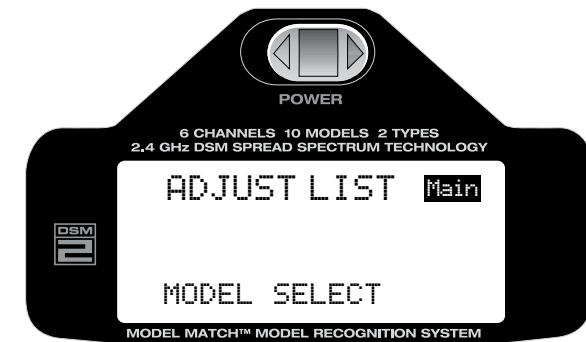

Rotate the roller to highlight SWASH TYPE then press the roller to access the swashplate type function.

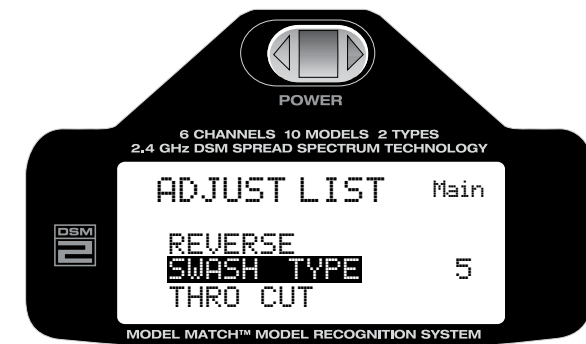

Rotate the roller to select 1 servo 90 degrees or CCPM 120 degrees swashplate mixing.

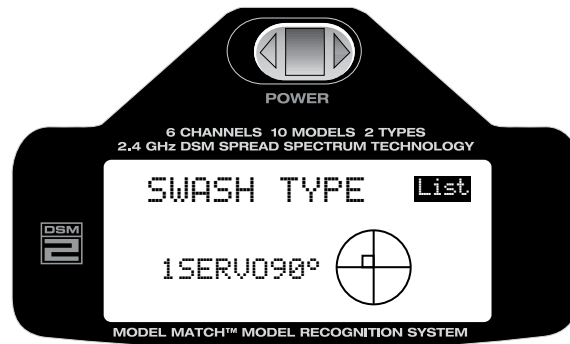

After the desired swashplate type is programmed press the roller to deselect the value.

TO RETURN TO THE MAIN SCREEN

Press and hold the roller for more than 3 seconds then release the roller and the system will return to the main screen.

TO RETURN TO THE SETUP LIST

Rotate the roller to highlight LIST in the upper right corner then pressing the roller will return the system to the SETUP LIST screen.

THROTTLE CUT

The DX6i offers a Throttle Cut function. When the Throttle Cut button is pressed, the throttle moves to a preprogrammed position (low throttle, low trim) allowing the safe and convenient shut down of the engine.

TO ACTIVATE THE THROTTLE CUT FUNCTION

Press the ROLLER and hold while turning on the transmitter. When SETUP LIST appears on screen release the roller.

Alternatively the setup list can be accessed from the main screen by pressing the roller to access the ADJUST LIST, then scrolling through the ADJUST LIST by rolling the roller to highlight SETUP LIST then pressing the roller.

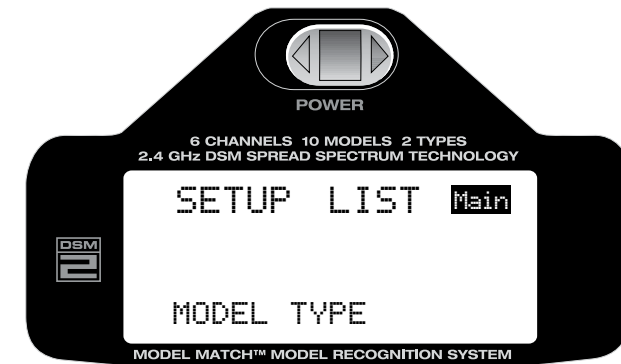

Rotate the roller to highlight THRO CUT then press the roller to access the Throttle Cut function.

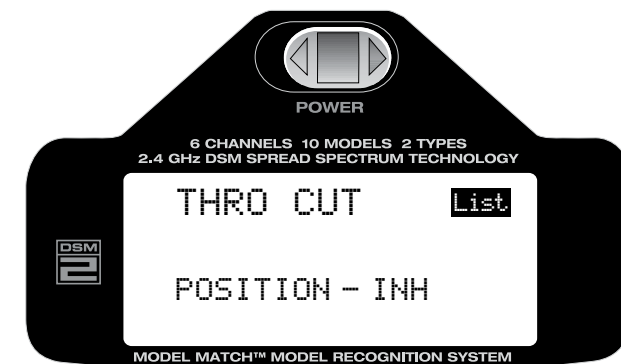
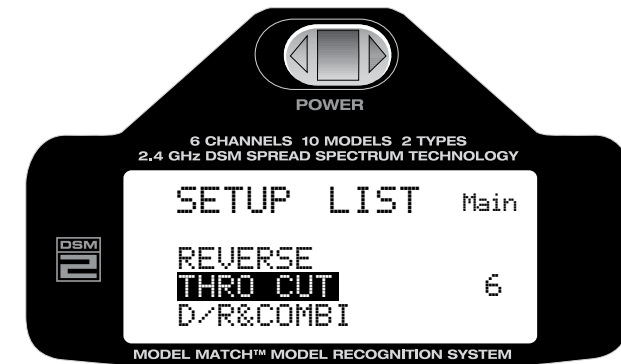

TO PROGRAM A THROTTLE CUT

Rotate the roller to highlight INH then press the roller to access INH. Now rotate the roller to ACT or INH the Throttle Cut function.

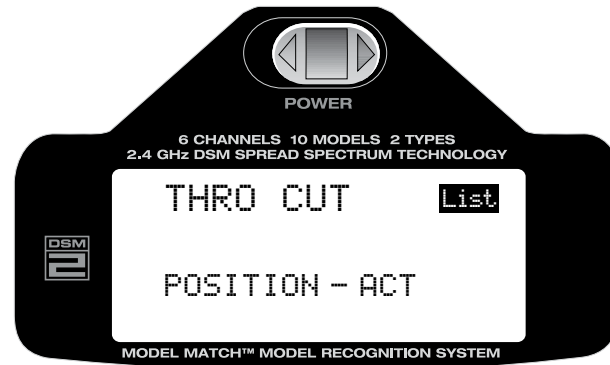

TO RETURN TO THE MAIN SCREEN

Press and hold the roller for more than 3 seconds then release the roller and the system will return to the main screen.

TO RETURN TO THE SETUP LIST

Rotate the roller to highlight LIST in the upper right corner then pressing the roller will return the system to the SETUP LIST screen.

D/R COMBI SWITCH ASSIGNMENT

The Dual Rate Combi switch assignment function allows the aileron, elevator and rudder dual rate and exponential functions to be assigned to one of four common switches such that the dual rates/expos for all three channels can be accessed using a single switch.

TO ACCESS DUAL RATE COMBI ASSIGNMENT

To access the Dual Rate Combi function rotate the roller to highlight D/R COMBI then press the roller to access the Dual Rate Combi function.

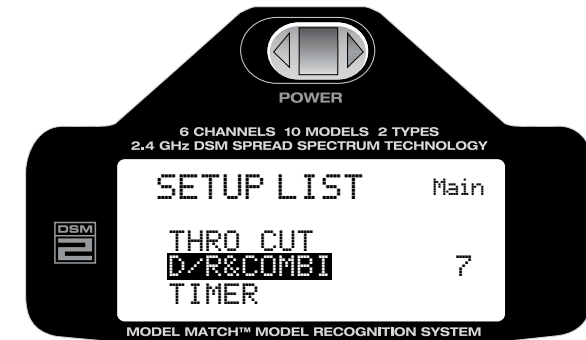
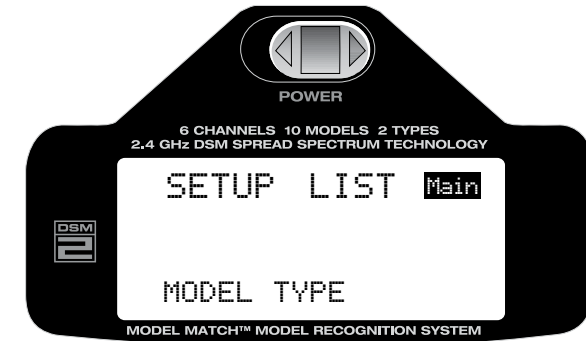

Rotate the roller to highlight IHN then press the roller. Now rotate the roller to select AILE, ELEV, RUDD or FM FLIGHT MODE.

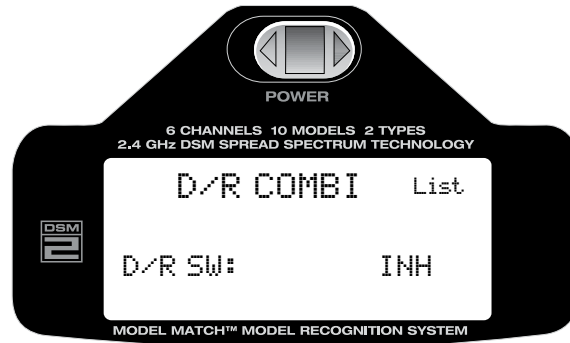

TO RETURN TO THE MAIN SCREEN

Press and hold the roller for more than 3 seconds then release the roller and the system will return to the main screen.

TO RETURN TO THE MAIN SCREEN

Press and hold the roller for more than 3 seconds then release the roller and the system will return to the main screen.

TO RETURN TO THE SETUP LIST

Rotate the roller to highlight LIST in the upper right corner then pressing the roller will return the system to the SETUP LIST screen.

Note: If INH is selected the aileron, elevator and rudder dual rate and expo functions independently operate using their respective switches.

TIMER

The DX6i features an on screen timer with two programming options:

DOWN-TIMER:

Down Timer - The countdown timer allows a preset time in ten-second intervals up to 59 minutes and 50 seconds to be programmed, and when that time expires, a beeper will sound five (5) beeps every five (5) seconds.

UP-TIMER:

Up Timer - The up timer function is a simple count-up timer that displays minutes and seconds up to 59 minutes and 59 seconds. The start time can be programmed. In most cases the default start setting of 00:00 is recommended.

When the DOWN-TIMER or UP-TIMER function is selected, the timer will be displayed on the main screen. The following buttons are used in conjunction to operate the timer function:

Trainer Timer button- when programmed Used to stop start and reset the timer.

Throttle Cut button- when programmed Used to start stop and reset the timer.

Note: To reset the timer press and hold the assigned timer switch (throttle cut or trainer) for more than 3 seconds.

TO SELECT THE TIMER FUNCTION

Press the ROLLER and hold while turning on the transmitter. When SETUP LIST appears on screen release the roller.

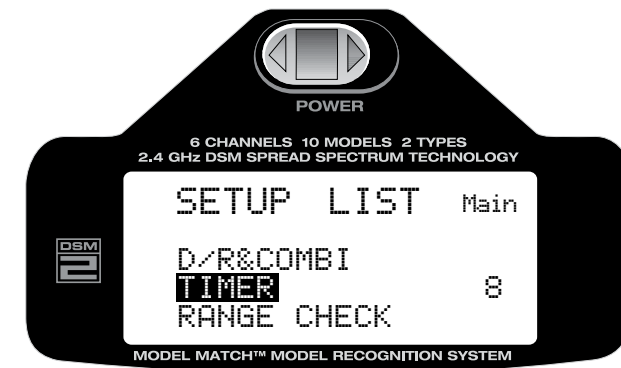

Alternatively the setup list can be accessed from the main screen by pressing the roller to access the ADJUST LIST then scrolling through the ADJUST LIST by rolling the roller to highlight SETUP LIST then press the roller.

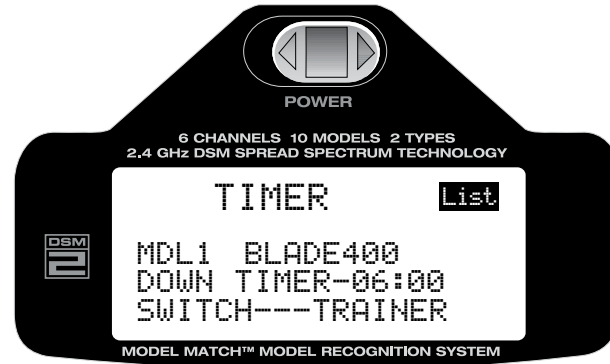

SETUP LIST SCREEN

Rotate the roller to highlight TIMER then press the roller to access the Timer function.

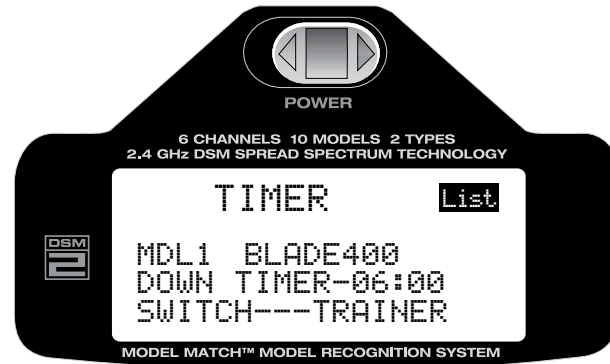

TO PROGRAM THE TIMER FUNCTION

Rotate the roller to highlight the desired timer function that you wish to change.

Up/Down- Selects the up or down timer function

Time- In minutes or seconds

Switch Options- Trainer or Throttle Cut

When the desired function is highlighted press the roller to access the function.

Rotate the roller to change the option or value.

TO RETURN TO THE MAIN SCREEN

Press and hold the roller for more than 3 seconds then release the roller and the system will return to the main screen.

TO RETURN TO THE SETUP LIST

Rotate the roller to highlight LIST in the upper right corner then pressing the roller will return the system to the SETUP LIST screen.

RANGE CHECK

RANGE CHECK: When activated the range check screen allows for a range check by using the trainer switch to reduce the output power.

TO ENTER THE RANGE CHECK FUNCTION

Press the ROLLER and hold while turning on the transmitter. When SETUP LIST appears on screen release the roller.

Alternatively the setup list can be accessed from the main screen by pressing the roller to access the ADJUST LIST, then scrolling through the ADJUST LIST by rolling the roller to highlight SETUP LIST then pressing the roller.

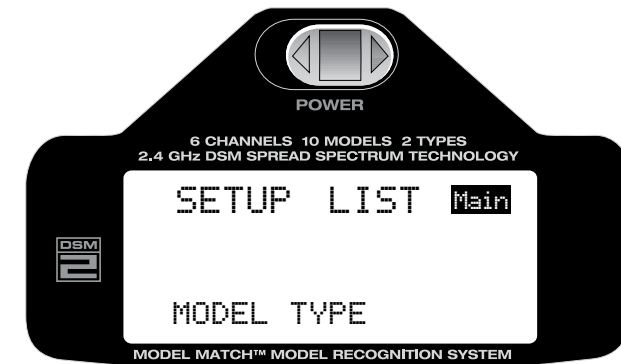

Rotate the roller to highlight RANGE CHECK then press the roller to access the RANGE CHECK function.

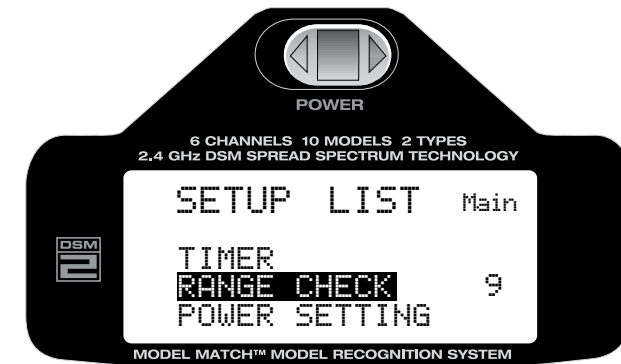

RANGE CHECKING A MODEL

Rotate the roller to highlight RANGE and press the roller to access the range function.

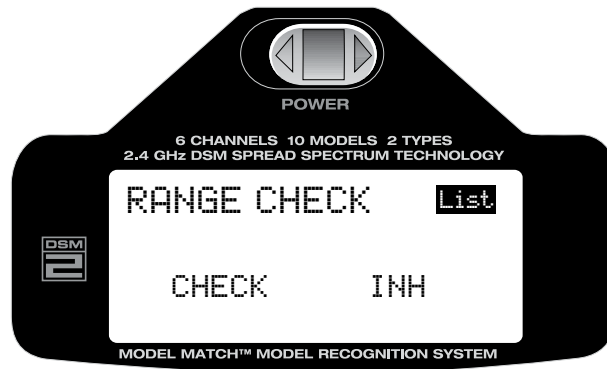

HOW TO RANGE TEST THE DX6I



RANGE TESTING THE DX6I

1. With the model on and resting on the ground, stand 30 paces (approx. 90 feet) away from the model.
2. Face the model with the transmitter in your normal flying position. Place the transmitter in the range test screen (see above) and pull and hold the trainer switch on the top of the transmitter. This causes reduced power output from the transmitter.
3. You should have total control of the model with the trainer switch pulled at 30 paces (90 feet).

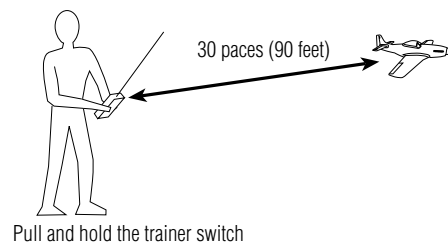

4. If control issues exist, call the Horizon Product Support Team at 1-877-504-0233 for further assistance.

POWER SETTING

The power setting screen is used to place the transmitter in one of two power settings. A-EU 328 is appropriate for most European countries conforming to EU 300-328, while B-US 247 should be selected for use in the United States and outside the EU.

TO ENTER THE POWER SETTING FUNCTION

Press the ROLLER and hold while turning on the transmitter. When SETUP LIST appears on screen release the roller.

Alternatively the setup list can be accessed from the main screen by pressing the roller to access the ADJUST LIST, then scrolling through the ADJUST LIST by rolling the roller to highlight POWER SETTING, then press the roller to access the POWER setting function.

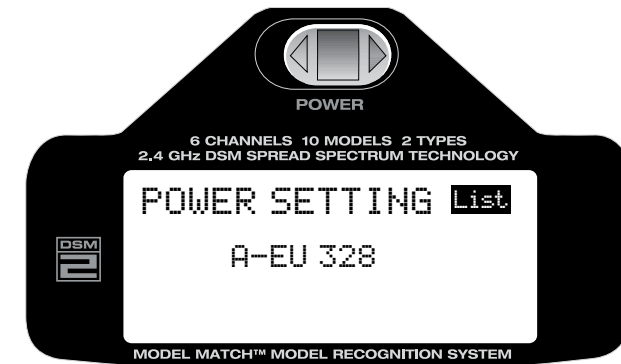
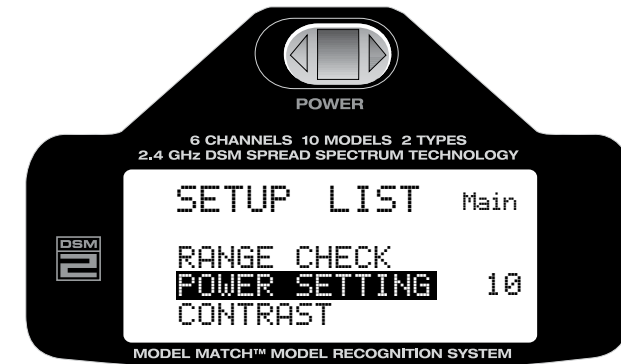

Rotate the roller to highlight the power setting then press the roller. now rotate the roller to select A-EU 328 for EU countries and or B-US247 if the system is to be used in the USA or non EU countries.

TO RETURN TO THE MAIN SCREEN

Press and hold the roller for more than 3 seconds then release the roller and the system will return to the main screen.

TO RETURN TO THE SETUP LIST

Rotate the roller to highlight LIST in the upper right corner then pressing the roller will return the system to the SETUP LIST screen.

CONTRAST

The contrast function allows the adjustment of the screen contrast.

TO ACCESS THE CONTRAST SCREEN

Rotate the roller to highlight CONTRAST then press the roller to access the contrast function.

Alternatively the setup list can be accessed from the main screen by pressing the roller to access the ADJUST LIST, then scrolling through the ADJUST LIST by rolling the roller to highlight SETUP LIST, then pressing the roller.

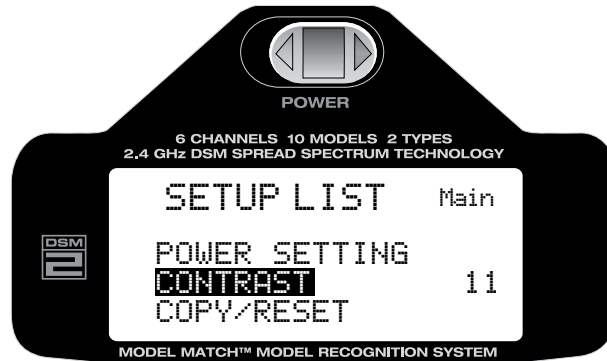
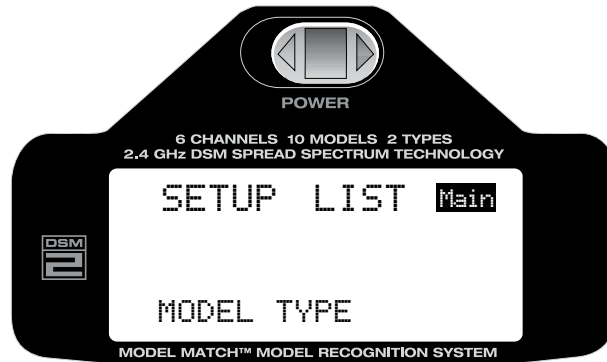

CONTRAST: Allows the adjustment of the screen contrast from 0 to 100%.

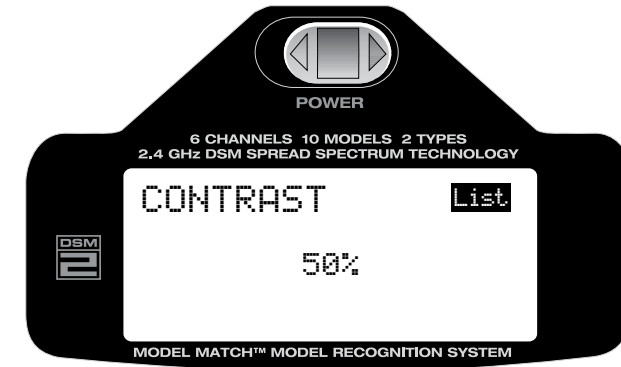

Rotate the roller to adjust the screen contrast from 0 to 100%.

TO RETURN TO THE MAIN SCREEN

Press and hold the roller for more than 3 seconds then release the roller and the system will return to the main screen.

TO RETURN TO THE SETUP LIST

Rotate the roller to highlight LIST in the upper right corner then pressing the roller will return the system to the SETUP LIST screen.

COPY/RESET

The COPY function allows the current model memory that is being used to be transferred to any of the other 9 available model memories. This is useful when experimenting with different model setups.

The Model Reset function allows the model memory of the current model to be reset to the factory default setting.

TO ENTER THE COPY/RESET FUNCTION

Press the ROLLER and hold while turning on the transmitter. When SETUP LIST appears on screen release the roller.



Alternatively the setup list can be accessed from the main screen by pressing the roller to access the ADJUST LIST, then scrolling through the ADJUST LIST by rolling the roller to highlight SETUP LIST, then pressing the roller.

SETUP LIST SCREEN

Rotate the roller to highlight COPY/RESET then press the roller to access the COPY/RESET function.

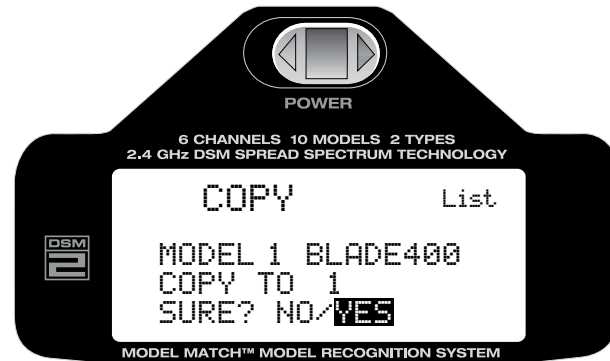

COPY/RESET SCREEN

TO ACCESS THE COPY FUNCTION

Rotate the roller to highlight COPY then press the roller to enter the COPY function.

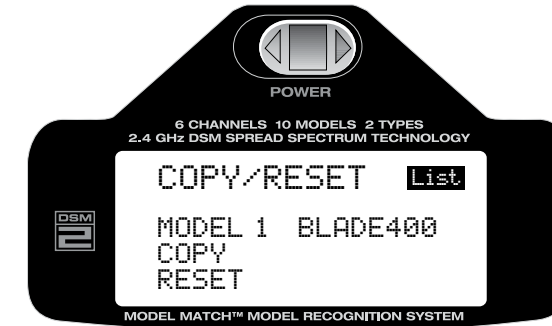

COPY SCREEN

Rotate the roller to COPY and select the model memory that you wish to copy by pressing the roller then rotating the roller.

When the desired model memory is selected press and rotate the roller to highlight YES next to SURE and then press the roller to copy the model to the selected memory.

Note: Be aware that the model you copy to will have its memory replaced with the new model's memory, and the programming information for the model to be copied to will be erased.

TO RETURN TO THE MAIN SCREEN

Press and hold the roller for more than 3 seconds then release the roller and the system will return to the main screen.

TO RETURN TO THE SETUP LIST

Rotate the roller to highlight LIST in the upper right corner then pressing the roller will return the system to the SETUP LIST screen.

TO PERFORM A RESET

Press the ROLLER and hold while turning on the transmitter to enter the SETUP LIST. When SETUP LIST appears on screen release the roller.

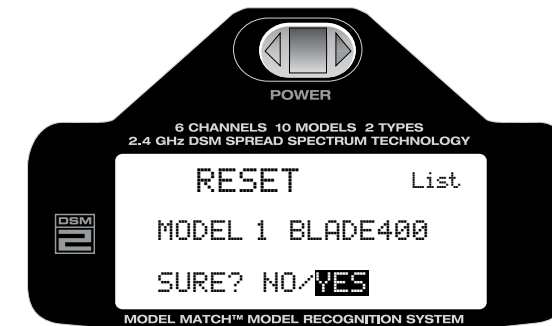

Alternatively the setup list can be accessed from the main screen by pressing the roller to access the ADJUST LIST, then scrolling through the ADJUST LIST by rolling the roller to highlight SETUP LIST, then pressing the roller.

SETUP LIST SCREEN

Rotate the roller to highlight COPY/RESET then press the roller to access the COPY/RESET function.

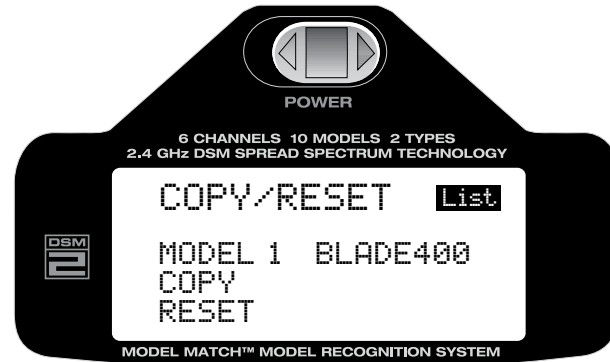

COPY/RESET SCREEN

TO ACCESS THE RESET FUNCTION

Rotate the roller to highlight RESET then press the roller to enter the RESET function.

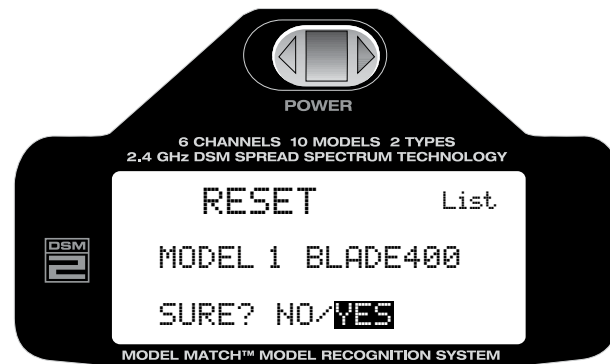

RESET SCREEN

Rotate the roller to YES, next to SURE, and then press the roller to reset the model to factory default settings.

TO RETURN TO THE MAIN SCREEN

Press and hold the roller for more than 3 seconds then release the roller and the system will return to the main screen.

TO RETURN TO THE SETUP LIST

Rotate the roller to highlight LIST in the upper right corner then pressing the roller will return the system to the SETUP LIST screen.

ADJUST LIST

The adjust list contains programming features that are commonly used to adjust flight characteristics. These functions included Dual Rate and Expo, Travel Adjust, Pitch and Throttle Curves, Mixes, etc. The Adjust List is accessible from the main screen by simply pressing the roller or is available through the SETUP LIST.

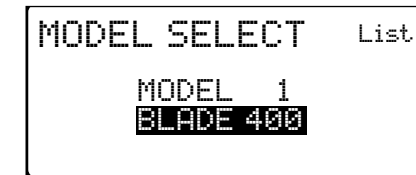

Model Select (Page 107)

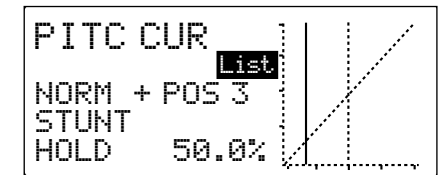

Pitch Curve (Page 121)

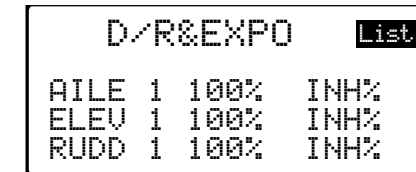

Dual Rate and Exponential (Page 109)

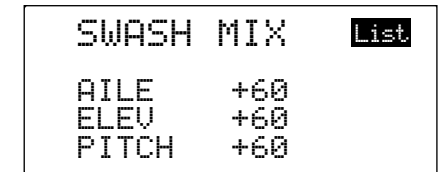

Swash Mix (Page 123)

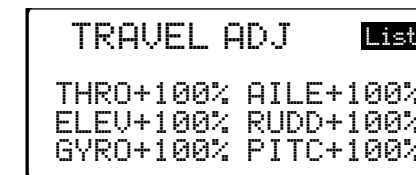

Travel Adjust (Page 111)

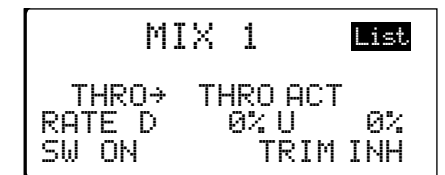

Mix 1 (Page 125)

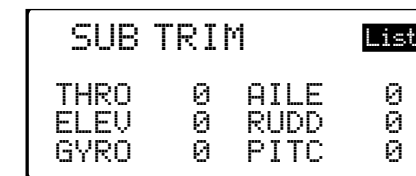

Sub Trim (Page 113)

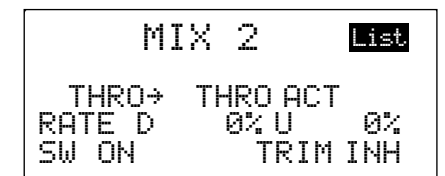

Mix 2 (Page 125)

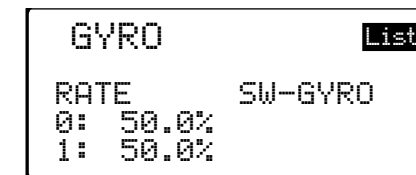

Gyro (Page 115)

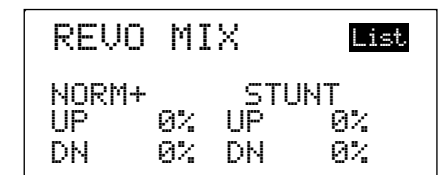

Revo Mix (Page 130)

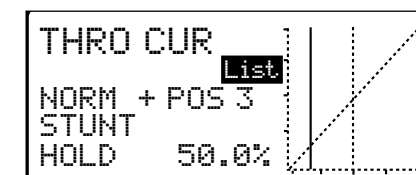

Throttle Curve (Page 118)

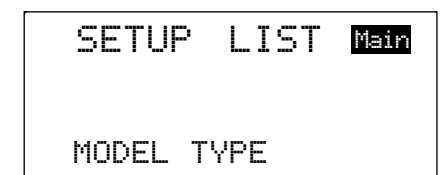

Setup List (Page 131)

TO ACCESS ADJUST LIST

With the transmitter already powered on and the main screen displayed, press and release the ROLLER to enter the ADJUST LIST.

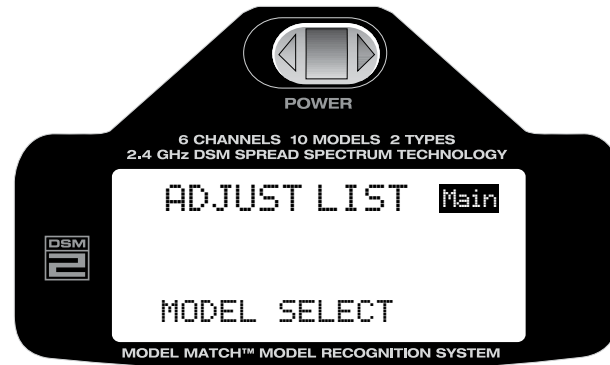

TO EXIT THE ADJUST LIST

Press and hold the roller for more than 3 seconds then release the roller and the system will return to the main screen.

Alternatively rotating the roller to highlight MAIN and pressing the roller will return to the MAIN screen.

MODEL SELECT

The DX6i features a memory function that stores the programmed data for up to 10 models. Any combination of up to 10 airplanes and/or helicopters can be stored in memory. A model name feature with up to eight characters allows each model to be easily identified. (See Page 83)

TO ENTER THE MODEL SELECT FUNCTION

With the transmitter already powered on and the main screen displayed, press and release the ROLLER to enter the ADJUST LIST.

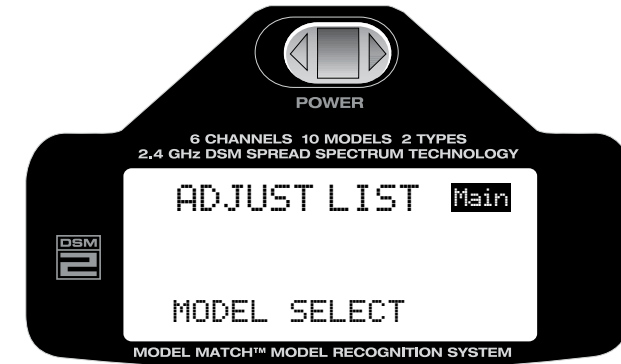

Rotate the ROLLER to the right until MODEL SELECT is highlighted on screen.

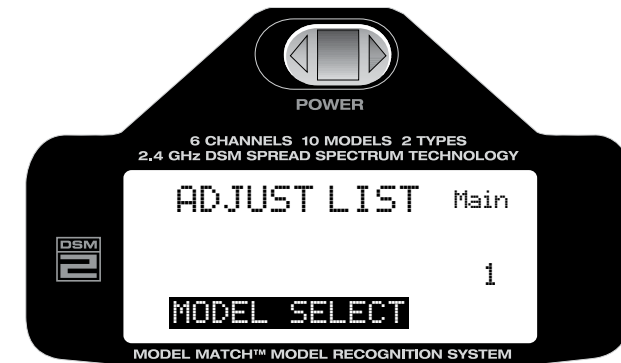

Press the roller to access the Model Select function.

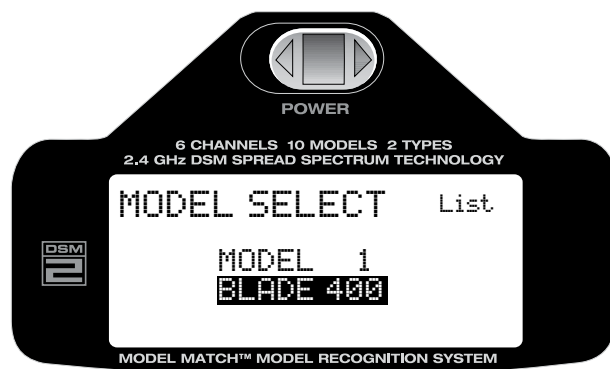

Rotate the roller to display the desired model that you wish to select. Ten models are available.

When the desired model is displayed press the roller to select the displayed model memory. DOWNLOAD... will appear for several seconds and the transmitter will beep indicating the model has been changed.

TO RETURN TO THE MAIN SCREEN

Press and hold the roller for more than 3 seconds then release the roller and the system will return to the main screen.

Alternatively highlighting MAIN with the roller and pressing the roller will return to the MAIN screen.

Turning the transmitter off then back on will also return to the main screen.

MODELMATCH

The DX6i features patented ModelMatch™ technology that prevents operating a model using the wrong memory. This feature can prevent stripped servo gears, broken linkages and even a crash due to trying to operate/ fly a model using the wrong memory.

HOW MODELMATCH WORKS

Each individual model memory has its own embedded code that is transferred to the receiver during binding. The receiver actually learns the code for the specific model memory that has been selected during binding and, when bound, will only operate when that model memory is selected. If a different (non-matching) model memory is selected, the receiver simply won't connect. This feature prevents trying to operate/ fly a model using the wrong model memory. The receiver can be re-programmed to operate with any other model memory by simply re-binding with the transmitter programmed to the desired model memory.

Note: If the receiver is turned on and the matching model memory is not selected, the system will not connect. Either select the matching model memory or rebind the receiver in the current model memory to resume operation.

DUAL RATE AND EXPONENTIAL

The Dual Rate and Exponential function allows two control rates to be programmed and selected with a switch. Dual rates and Expos are available on the aileron, elevator and rudder channels. Changing the dual rate value not only affects the maximum control authority but also affects the overall sensitivity of control. A higher rate yields a higher overall sensitivity. The sensitivity around center can be tailored using the Exponential function to precisely adjust control feel.

Dual and Expo rates can be controlled by their respective dual rate switches (aileron, elevator and rudder) or by 1 common switch (Aileron D/R, Elevator D/R, Rudder D/R or the Gear switch). See COMBI SWITCH screen on page 93 for detail on combining the Dual rate switches.

Dual rate values are adjustable from 0–100%. The factory default settings for both the 0 and 1 switch positions are 100%. Exponential values are adjustable from -100% to +100% with a factory default of 0% or inhibit. Either switch position may be selected as the low or high rate by placing the switch in the desired position and adjusting the value accordingly.

Note: A negative (-) Expo value will increase sensitivity around neutral, and a positive (+) Expo value will decrease sensitivity around neutral. Normally a positive value is used to desensitize control response around neutral.

TO ADJUST THE DUAL AND EXPO RATES

With the transmitter already powered on and the main screen displayed, press and release the ROLLER to enter the ADJUST LIST.

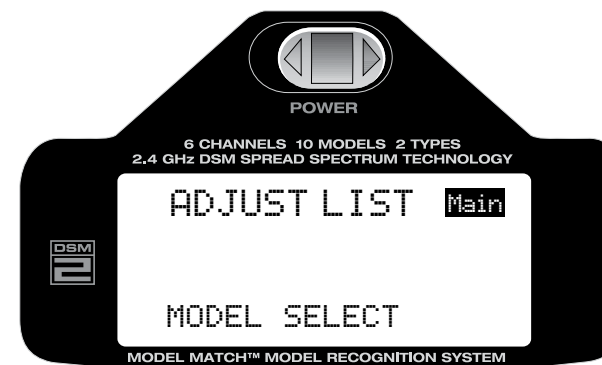

Rotate the ROLLER to the right until D/R&COMBI is highlighted on screen.

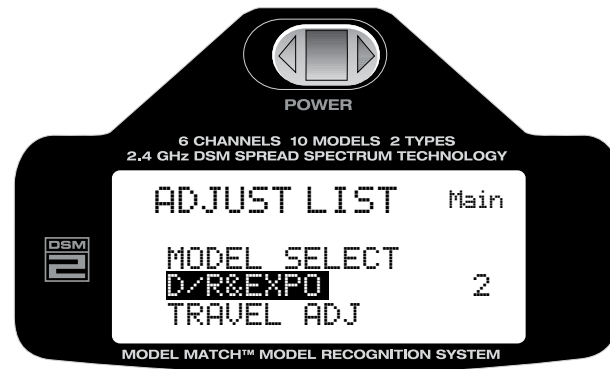

Press the roller to access the Dual Rate and Expo function.

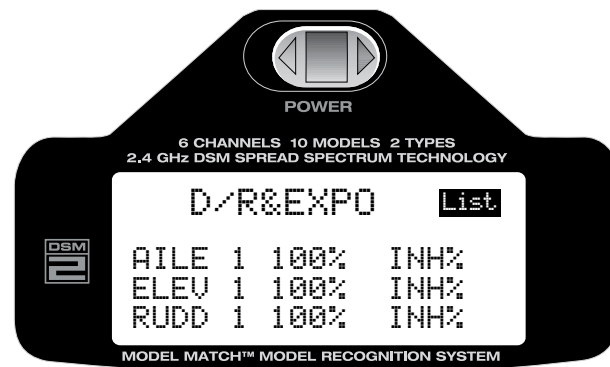

Move the respective D/R switch in the desired position (0 or 1) that you wish to change.

Rotate the roller to highlight the desired channel's EXPO or D/R value that you wish to adjust.

Press the roller to access the D/R or EXPO value.

Rotate the roller to adjust the D/R or EXPO value.

After the desired value is programmed press the roller to deselect the value.

TO RETURN TO THE MAIN SCREEN

Press and hold the roller for more than 3 seconds then release the roller and the system will return to the main screen.

TO RETURN TO THE ADJUST LIST SCREEN

Rotate the roller to highlight LIST then press the roller.

The Dual Rate and Expo functions for aileron, elevator and rudder can be combined on a single switch conveniently allowing high or low rates to be selected via one switch. The choices for this are found on the COMBI SWITCH on page 93.

TRAVEL ADJUST

The Travel Adjust function allows the precise end-point adjustments of all six channels in each direction independently. The travel adjust range is from 0–125%.

Channels available for programming are:

- THRO: Throttle
- AILE: Aileron
- ELEV: Elevator
- RUDD: Rudder
- GYRO: Gyro gain
- PITCH: Pitch

TO ACCESS THE TRAVEL ADJUST FUNCTION

With the transmitter already powered on and the main screen displayed, press and release the ROLLER to enter the ADJUST LIST.



Rotate the ROLLER to the right until TRAVEL ADJ is highlighted on screen.



Press the roller to access the TRAVEL ADJ function.

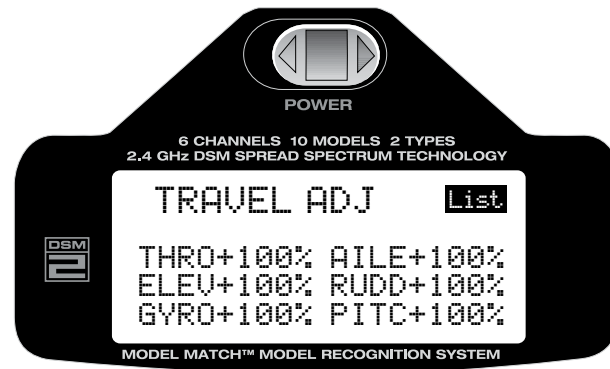

Move the respective stick or switch in the desired direction that you wish to change the travel adjust.

Rotate the roller to highlight the desired channel's value that you wish to adjust.

Press the roller to access the travel adjust value.

Rotate the roller to adjust the travel adjust value.

After the desired value is programmed press the roller to deselect the value.

TO RETURN TO THE MAIN SCREEN

Press and hold the roller for more than 3 seconds then release the roller and the system will return to the main screen.

TO RETURN TO THE ADJUST LIST SCREEN

Rotate the roller to highlight LIST then press the roller.

SUB-TRIM

The Sub-Trim function allows you to electronically adjust the centering of each servo. Sub trim is individually adjustable for all seven channels, with a range of + or - 100% (+ or - 30 degrees servo travel).

Caution: Do not use excessive sub-trim values as it is possible to overdrive the servo's maximum travel.

The channels available are:

- THRO: Throttle
- AILE: Aileron
- ELEV: Elevator
- RUDD: Rudder
- GYRO: Gyro gain
- PITCH: Pitch

TO ACCESS THE SUB-TRIM FUNCTION

With the transmitter already powered on and the main screen displayed, press and release the ROLLER to enter the ADJUST LIST.



Rotate the ROLLER to the right until SUB TRIM is highlighted on screen.



Press the roller to access the SUB TRIM function.

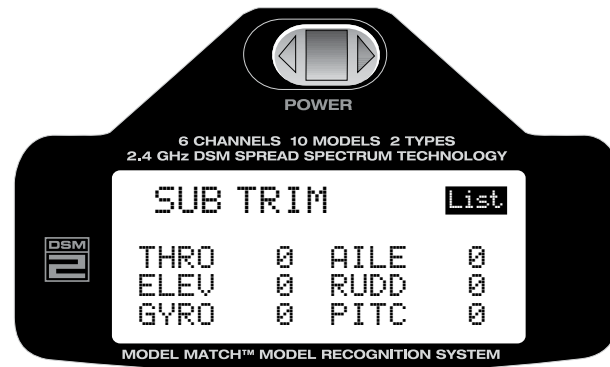

Rotate the roller to highlight the desired channel's value that you wish to adjust.

Press the roller to access the sub trim value.

Rotate the roller to adjust the sub trim value.

After the desired value is programmed press the roller to deselect the value.

TO RETURN TO THE MAIN SCREEN

Press and hold the roller for more than 3 seconds then release the roller and the system will return to the main screen.

TO RETURN TO THE ADJUST LIST SCREEN

Rotate the roller to highlight LIST then press the roller.

GYRO

The gyro function offers two selectable gyro gain values that can be selected via the flight mode switch or the gyro switch. When active the Gyro's gain channel is plugged into the gear channel/(channel 5).

ACCESSING THE GYRO FUNCTION

With the transmitter already powered on and the main screen displayed, press and release the ROLLER to enter the ADJUST LIST.



Rotate the ROLLER to the right until GYRO is highlighted on screen.



Press the roller to access the GYRO screen.

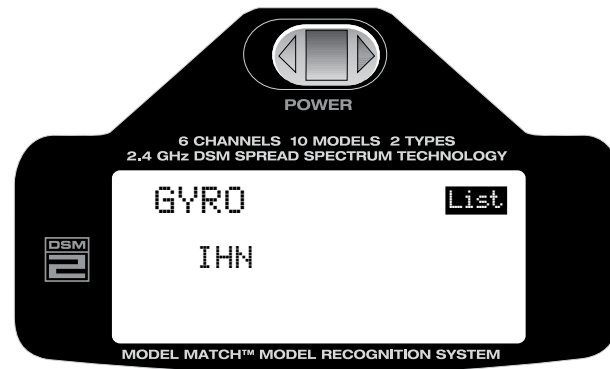

Rotating the roller Highlight INH then press the roller.

Rotate the roller to ACT then press the roller to activate the GYRO function.

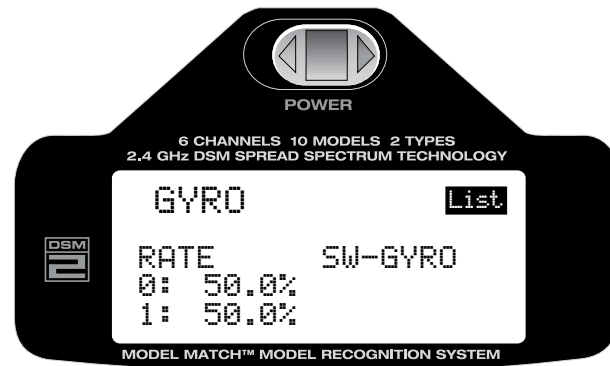

Rotate the roller to highlight the desired rate or switch that you wish to adjust.

Press the roller to access the selected Rate or Value.

Rotate the roller to select switch position values of 0 or 1.

SWITCH LOCATION GYRO, F.MODE OR INH

If F.MODE is selected the option of choosing either rate that is assigned to NORM or STUNT modes is available. By assigning 0 or 1 to NORM or STUNT, the gain value is automatically selected whenever the Normal or Stunt flight mode is selected.

After the desired value or switch is programmed press the roller to deselect the value.

TO RETURN TO THE MAIN SCREEN

Press and hold the roller for more than 3 seconds then release the roller and the system will return to the main screen.

TO RETURN TO THE ADJUST LIST SCREEN

Rotate the roller to highlight LIST then press the roller.

THROTTLE CURVE

The DX6i offers two (2) separate throttle curves with five (5) adjustable points per curve. This function allows you to adjust the throttle curve to optimize engine rpm at a particular pitch setting. Once the throttle curves are established, each can be activated in flight using the 2-position flight mode switch. The flight mode switch offers two (2) selectable curves: 0=Normal, 1=Stunt.

The 0, or Normal, position should be used for starting the engine and hovering. Position 1, or Stunt, should be used for aerobatic maneuvers and forward flight.

Each of the five (5) positions of the throttle curve are independently adjustable from 0–100%. These five (5) positions correspond to the position of the throttle stick.

The transmitter is factory preset to the throttle curve as indicated by the solid line in the figure below. Individual points can be activated and increased/decreased to suit your specific needs.

TO ACCESS THE THROTTLE CURVE FUNCTION

With the transmitter already powered on and the main screen displayed, press and release the ROLLER to enter the ADJUST LIST.



Rotate the ROLLER to the right until THRO CUR is highlighted on screen.



Press the roller to access the Throttle Curve function.

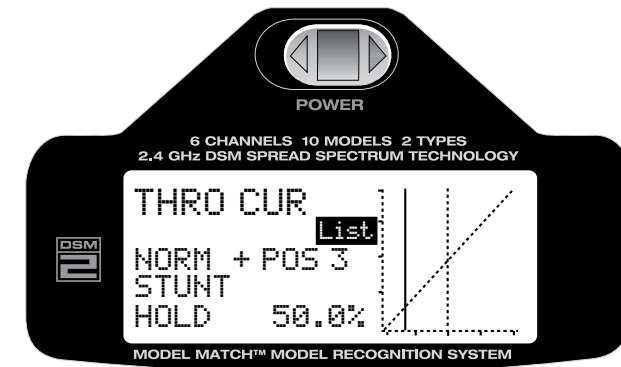

Rotate the roller to highlight the desired throttle curve that you wish to adjust.

NORM-	Normal
STUNT-	Stunt mode
HOLD-	Hold

Press the roller to access the selected throttle curve.

Rotate the roller to select the throttle curve position that you wish to adjust. Note the graph. The vertical line represents the selected position that you have selected. Position options are:

L=	Low throttle stick position
2=	25% stick position
3=	50% stick position
4=	75% stick position
H=	Full stick position

When selected press the roller to access the throttle value.

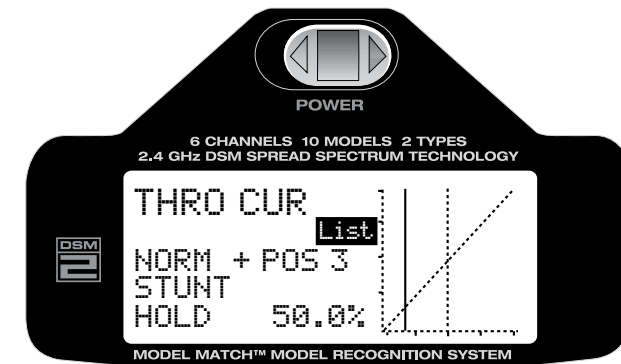

Rotate the roller to adjust the throttle value at the select stick position.

After the desired value is programmed press the roller to deselect the value.

Note: In Throttle Hold the throttle curve is a flat line representing a hold condition. The Hold position can be adjusted using the values as above.

Repeat this step for all stick positions and for all flight modes.

TO RETURN TO THE MAIN SCREEN

Press and hold the roller for more than 3 seconds then release the roller and the system will return to the main screen.

TO RETURN TO THE ADJUST LIST SCREEN

Rotate the roller to highlight LIST then press the roller.

THROTTLE TRIM SETTING

The throttle trim lever is only active when the flight mode switch is in the normal position. The throttle trim is used to increase or decrease the engine rpm to achieve a reliable idle when in the Normal Mode. The throttle trim lever has no effect in flight modes 1 (Stunt), or in throttle hold.

PITCH CURVE

Adjustment of the pitch curve is very similar to the throttle curve adjustment described in the preceding section. A thorough understanding of the throttle curve section will make pitch curve adjustment easier to understand.

The DX6i offers three (3) independent pitch curves: Normal, Stunt 1, Hold. Each pitch curve contains five (5) adjustable points — L, 1, 2, 3 and H.

TO ACCESS THE PITCH CURVE FUNCTION

With the transmitter already powered on and the main screen displayed, press and release the ROLLER to enter the ADJUST LIST.



Rotate the ROLLER to the right until PITC CUR is highlighted on screen.



Press the roller to access the Pitch Curve function.

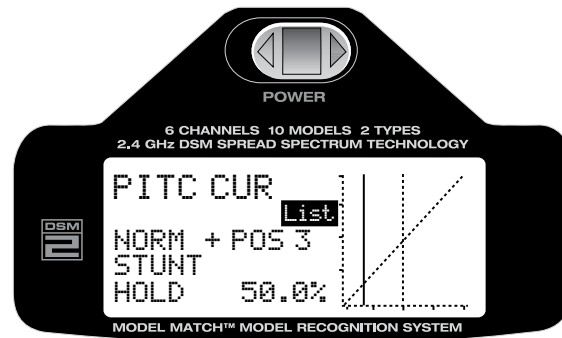

Rotate the roller to highlight the desired pitch curve that you wish to adjust.

- NORM- Normal
- STUNT- Stunt mode
- HOLD- Hold

Press the roller to access the selected pitch curve.

Rotate the roller to select the pitch curve position that you wish to adjust. Note the graph. The vertical line represents the selected position that you have chosen. Position options are:

- L= Low throttle stick position
- 2= 25% stick position
- 3= 50% stick position
- 4= 75% stick position
- H= Full stick position

When selected press the roller to access the pitch value.

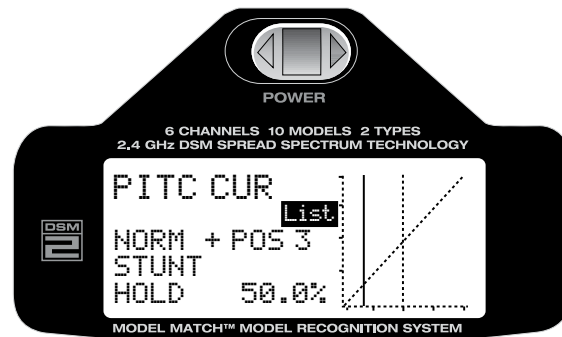

Rotate the roller to adjust the pitch value at the select stick position.
After the desired value is programmed press the roller to deselect the value.
Repeat this step for all stick positions and all flight modes.

TO RETURN TO THE MAIN SCREEN

Press and hold the roller for more than 3 seconds then release the roller and the system will return to the main screen.

TO RETURN TO THE ADJUST LIST SCREEN

Rotate the roller to highlight LIST then press the roller.

SWASHPLATE MIXING

The Swashplate Mix screen adjusts the amount and direction of travel for the aileron, elevator and pitch functions. For example, if more aileron travel is desired, increasing the aileron swashplate mix value will increase the overall travel of the servos necessary to achieve greater aileron throw. Defaults are set to +60%.

Note: Negative swashplate values are available which will reverse the direction of that function. Use Servo Reversing (page 87) to change the direction of individual servos in conjunction with positive or negative swashplate mix values to reverse the direction of all the servos associated with that function to achieve the correct travel direction of the swashplate.

ACCESSING THE SWASHPLATE MIX FUNCTION

With the transmitter already powered on and the main screen displayed, press and release the ROLLER to enter the ADJUST LIST.

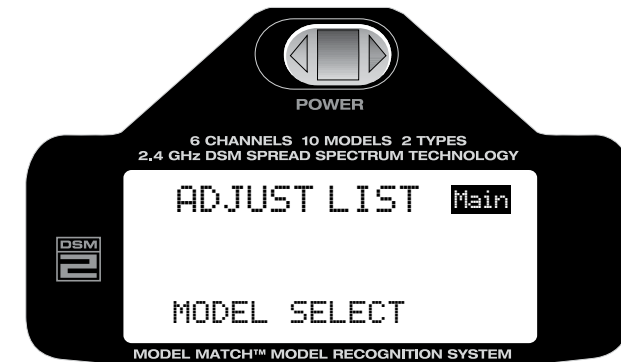

Rotate the ROLLER to the right until SWASH MIX is highlighted on screen.



Press the roller to access the Swashplate Mix function.

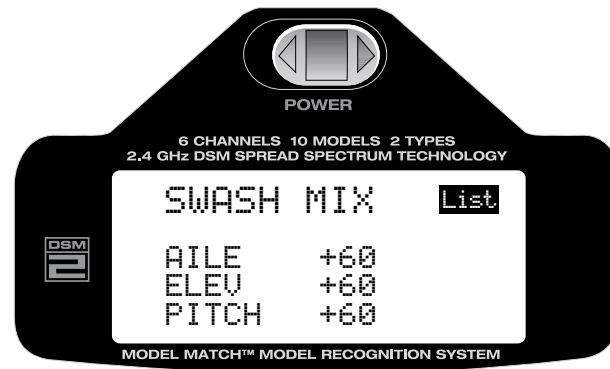

Rotate the roller to highlight the desired channel that you wish to adjust.

AILE- Aileron
ELEV- Elevator
PITC- Pitch

Press the roller to access the selected channel's value.

Rotate the roller to select adjust the selected value.

After the desired value is programmed press the roller to deselect the value.

TO RETURN TO THE MAIN SCREEN

Press and hold the roller for more than 3 seconds then release the roller and the system will return to the main screen.

TO RETURN TO THE ADJUST LIST SCREEN

Rotate the roller to highlight LIST then press the roller.

PROGRAMMABLE MIXING 1 AND 2

The DX6i offers two programmable mixes that allow stick or switch inputs to control the output of two or more servos. This function allows mixing any one channel to any other channel, or the ability to mix a channel to itself. The mix can remain ON at all times, or it can be switched OFF in flight, using a number of different switches. Mix values are adjustable from -125% to 125%. Each channel is identified by a four-character name (i.e., Aileron - AILE, Elevator - ELEV, etc.). The channel appearing first is the master channel. The second channel is the slave channel. For example, AILE - RUDD would indicate aileron-to-rudder mixing. Each time the aileron stick is moved, the aileron will deflect, and the rudder will automatically move in the direction and to the position based on the value input in the programmable mix screen. Mixing is proportional, so small inputs of the master channel will produce small outputs of the slave channel. Both mixes offer a trim feature that, when activated, affect the master channel's trim and also the slave channel.

ACCESSING PROGRAMMABLE MIX 1 OR MIX 2

With the transmitter already powered on and the main screen displayed, press and release the ROLLER to enter the ADJUST LIST.

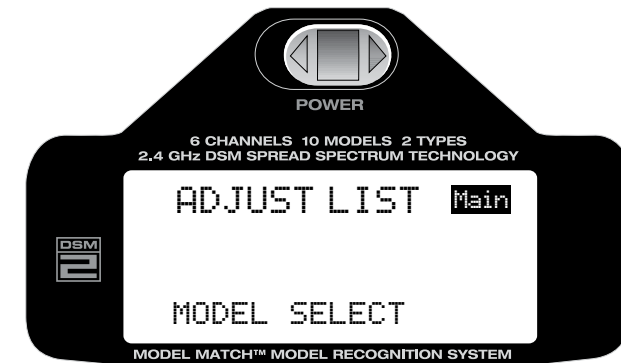

Rotate the ROLLER to the right until MIX 1 is highlighted on screen.

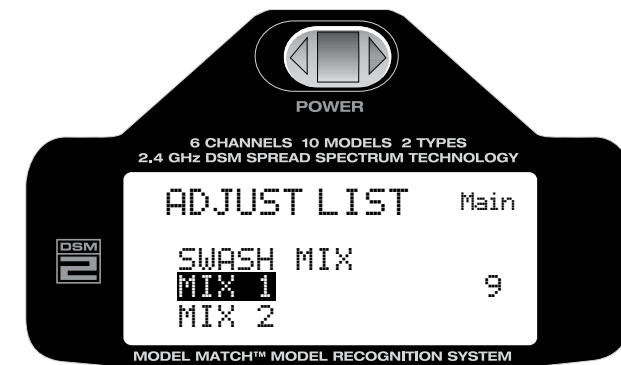

Press the roller to access the MIX 1 function.

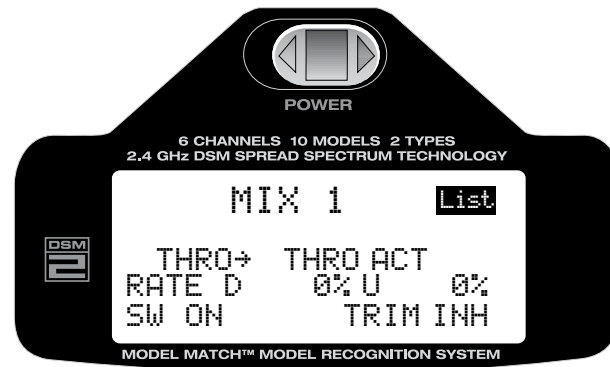

SELECTING MASTER AND SLAVE CHANNELS

Rotate the roller to highlight the master (left) channel in the screen.



Press the roller to access the master channel selection.

Rotate the roller to select the desired master channel.

- THRO: Throttle
- AILE: Aileron
- ELEV: Elevator
- RUDD: Rudder
- GYRO: Gyro
- PITC: Pitch

Press the roller to deselect the master channel then rotate the roller to select the slave channel.

Press the roller to access the slave channel selection.

Rotate the roller to select the desired slave channel.

- THRO: Throttle
- AILE: Aileron
- ELEV: Elevator
- RUDD: Rudder
- GYRO: Gyro
- PITC: Pitch

SELECTING THE MIXING VALUES

Rotate the roller to highlight the desired rate and direction.



Press the roller to access the rate value.

Using the roller, rotate to adjust the desired mixing values. Note that positive + and negative – values are available and affect the direction of the slave servo travel.

After the desired value is programmed press the roller to deselect the value.

SWITCH FUNCTIONS

The Mixes can be turned off and on using one of the following switches.

ON-	Always on
F MODE-	F switch forward
GYRO-	Gyro switch down
AIL D/R-	Aileron dual rate switch up
ELE D/R-	Elevator dual rate switch up
MIX-	Mix switch forward

TO PROGRAM THE MIX SWITCH

Rotate the roller to highlight SW.

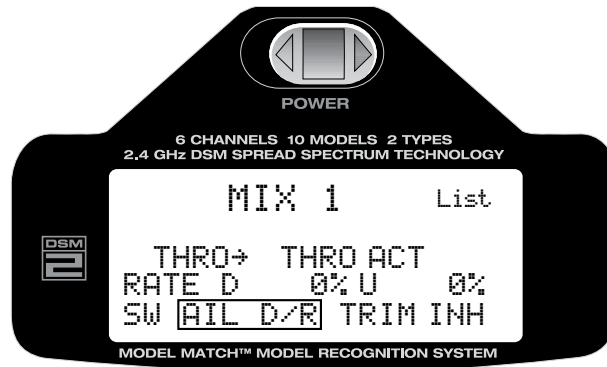

Press the roller to access the switch selection function.

Rotate the roller to select the desired switch.

After the desired switch is programmed press the roller to deselect the value.

TRIM INCLUDE FUNCTION

Both mixes offer a trim feature that, when activated, cause the master channel's trim to affect the slave channel.

TO PROGRAM THE TRIM INCLUDE FUNCTION

Rotate the roller to highlight TRIM.

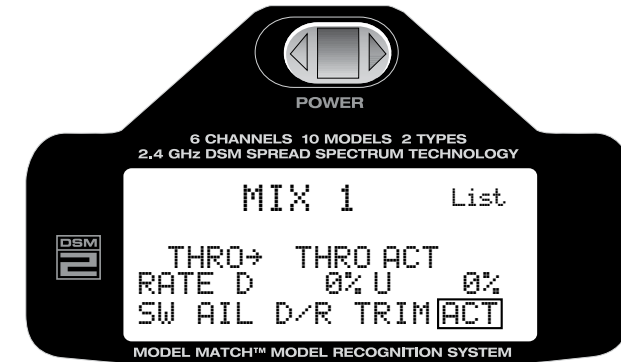

Press the roller to access the trim function.

Rotate the roller to select ACT (activate) or INH (inhibit).

After the trim function is programmed press the roller to deselect the value.

TO RETURN TO THE MAIN SCREEN

Press and hold the roller for more than 3 seconds then release the roller and the system will return to the main screen.

TO RETURN TO THE ADJUST LIST SCREEN

Rotate the roller to highlight LIST then press the roller.

REVOLUTION MIXING (ONLY USED WITH NON-HEADING HOLD GYROS)

The Revolution Mixing Function mixes tail rotor input with the Throttle/Collective function to counteract torque from the main rotor blades. When set up correctly, the helicopter should climb and descend without a tendency to yaw in either direction. Because torque reaction varies with different power settings, it is necessary to vary the tail rotor pitch at the same time. The DX6i offers two (2) separate revolution mixing programs with independent up and down mixing for each—one for flight mode position 0, and the other for Stunt mode. The U, or Up, mixing adjusts the tail rotor compensation for the mid to high throttle/stick setting, and the D, or Down, mixing adjusts the tail rotor compensation for the mid to low throttle/stick setting.

SETTING UP REVOLUTION MIXING

First, adjust the helicopter so that it will hover in a neutral position with the tail rotor trim at center. Next, establish the helicopter into a stable hover; then steadily increase the throttle to initiate a stable climb. The body of the helicopter will move in the opposite direction to the main rotor rotation. Increase the U, or Up, setting until the helicopter will climb with no tendency to turn or rotate. At a safe altitude, close the throttle and the helicopter will descend with the body turning in the same direction as the main rotor. Increase the D, or Down, mix until the helicopter descends with no tendency to turn or rotate. When attempting this procedure, throttle stick movements should be slow, and the initial acceleration and deceleration swings should be overlooked.

TO ACCESS REVOLUTION MIXING

With the transmitter already powered on and the main screen displayed, press and release the ROLLER to enter the ADJUST LIST.

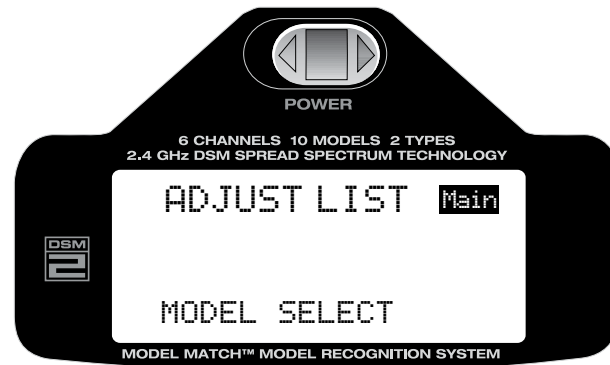

Rotate the ROLLER to the right until REVO MIX is highlighted on screen.



Press the roller to access the Revolution Mixing function.

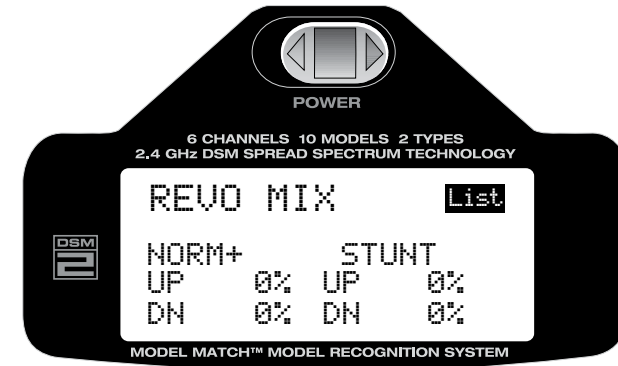

Rotate the roller to highlight the desired value that you wish to adjust.

Press the roller to access the selected value.

Rotate the roller to select adjust the selected value.

After the desired value is programmed press the roller to deselect the value.

TO RETURN TO THE MAIN SCREEN

Press and hold the roller for more than 3 seconds then release the roller and the system will return to the main screen.

TO RETURN TO THE ADJUST LIST SCREEN

Rotate the roller to highlight LIST then press the roller.

SETUP LIST

The SETUP list contains the programming functions that are normally only used during the initial setup of the model (i.e. model type, servo reverse, model name).

TO RETURN TO THE MAIN SCREEN

Press and hold the roller for more than 3 seconds then release the roller and the system will return to the main screen.

TO RETURN TO THE ADJUST LIST SCREEN

Rotate the roller to highlight LIST then press the roller.

GENERAL INFORMATION

Servo Precautions

- Do not lubricate servo gears or motors.
- Do not overload retract servos during retracted or extended conditions. Make sure they are able to travel their full deflection. Overloading or stalling a servo can cause excessive current drain.
- Make sure all servos move freely through their rotations and no linkages hang up or bind. A binding control linkage can cause a servo to draw excessive current. A stalled servo can drain a battery pack in a matter of minutes.
- Correct any control surface “buzz” or “flutter” as soon as it is noticed in flight, as this condition can destroy the feedback potentiometer in the servo. It may be extremely dangerous to ignore such “buzz” or “flutter.”
- Use the supplied rubber grommets and brass servo eyelets when mounting your servos. Do not over-tighten the servo mounting screws, as this negates the dampening effect of the rubber grommets.
- Ensure the servo horn is securely fastened to the servo. Use only the servo arm screws provided; the size is different from other manufacturers.
- Discontinue to use servo arms when they become “yellowed” or discolored. Such servo arms may be brittle and can snap at any time, possibly causing the aircraft to crash.
- Check all related mounting screws and linkages frequently. Aircraft often vibrate, causing linkages and screws to loosen.

General Notes

Radio controlled models are a great source of pleasure. Unfortunately, they can also pose a potential hazard if not operated and maintained properly.

It is imperative to install your radio control system correctly. Additionally, your level of piloting competency must be high enough to ensure that you are able to control your aircraft under all conditions. If you are a newcomer to radio controlled flying, please seek help from an experienced pilot or your local hobby store.

Safety Do's and Don'ts for Pilots

- Ensure that your batteries have been properly charged prior to your initial flight.
- Keep track of the time the system is turned on so you will know how long you can safely operate your system.
- Perform a ground range check prior to the initial flight of the day. See the “Daily Flight Checks Section” for information.
- Check all control surfaces prior to each takeoff.
- Do not fly your model near spectators, parking areas or any other area that could result in injury to people or damage of property.
- Do not fly during adverse weather conditions. Poor visibility can cause disorientation and loss of control of your aircraft. Strong winds can cause similar problems.
- Do not point the transmitter antenna directly toward the model. The radiation pattern from the tip of the antenna is inherently low.
- Do not take chances. If at any time during flight you observe any erratic or abnormal operation, land immediately and do not resume flight until the cause of the problem has been ascertained and corrected. Safety can never be taken lightly.

Federal Aviation Administration

Purpose

This advisory outlines safety standards for operations of model aircraft. We encourage voluntary compliance with these standards.

Background

Attention has been drawn to the increase in model aircraft operation. There is a need for added caution when operating free flight and radio controlled craft in order to avoid creating a noise nuisance or a potential hazard to full-scale aircraft and persons and/or property on the surface.

Operating Standards

Modelers generally are concerned with safety and exercise good judgment when flying model aircraft. However, in the interest of safer skies, we encourage operators of radio controlled and free flight models to comply with the following standards:

- a. Exercise vigilance in locating full-scale aircraft (get help if possible) so as not to create a collision hazard.
- b. Select an operating site at sufficient distance from populated areas so you do not create a noise problem or a potential hazard.
- c. Do not fly higher than 400 feet above the surface.
- d. Always operate more than three miles from the boundary of an airport unless you are given permission to be closer by the appropriate air traffic control facility in the case of an airport for which a control zone has been designated or by the airport manager in the case of other airports.
- e. Do not hesitate to ask for assistance in complying with these guidelines at the airport traffic control tower or air route traffic control center nearest the site of your proposed operation.

Information Provided By

Director, Air Traffic Service Federal Aviation Administration, Washington, D.C.

Daily Flight Checks

1. Check the battery voltage on both the transmitter and the receiver battery packs. Do not fly below 4.3V on the transmitter or below 4.7V on the receiver. To do so can crash your aircraft.

Note: When you check these batteries, ensure that you have the polarities correct on your expanded scale voltmeter.

2. Check all hardware (linkages, screws, nuts, and bolts) prior to each day's flight. Be sure that binding does not occur and that all parts are properly secured.
3. Ensure that all surfaces are moving in the proper manner.
4. Perform a ground range check before each day's flying session.
5. Prior to starting your aircraft, turn off your transmitter, then turn it back on. Do this each time you start your aircraft. If any critical switches are on without your knowledge, the transmitter alarm will warn you at this time.
6. Check that all trim levers are in the proper location.
7. All servo pigtails and switch harness plugs should be secured in the receiver. Make sure that the switch harness moves freely in both directions.

ONE-YEAR WARRANTY PERIOD

Exclusive Warranty- Horizon Hobby, Inc., (Horizon) warrants that the Products purchased (the "Product") will be free from defects in materials and workmanship for a period of One (1) year from the date of purchase by the Purchaser.

LIMITED WARRANTY

(a) This warranty is limited to the original Purchaser ("Purchaser") and is not transferable. REPAIR OR REPLACEMENT AS PROVIDED UNDER THIS WARRANTY IS THE EXCLUSIVE REMEDY OF THE PURCHASER. This warranty covers only those Products purchased from an authorized Horizon dealer. Third party transactions are not covered by this warranty. Proof of purchase is required for warranty claims. Further, Horizon reserves the right to change or modify this warranty without notice and disclaims all other warranties, express or implied.

(b) Limitations- HORIZON MAKES NO WARRANTY OR REPRESENTATION, EXPRESS OR IMPLIED, ABOUT NON-INFRINGEMENT, MERCHANTABILITY OR FITNESS FOR A PARTICULAR PURPOSE OF THE PRODUCT. THE PURCHASER ACKNOWLEDGES THAT THEY ALONE HAVE DETERMINED THAT THE PRODUCT WILL SUITABLY MEET THE REQUIREMENTS OF THE PURCHASER'S INTENDED USE.

(c) Purchaser Remedy- Horizon's sole obligation hereunder shall be that Horizon will, at its option, (i) repair or (ii) replace, any Product determined by Horizon to be defective. In the event of a defect, these are the Purchaser's exclusive remedies. Horizon reserves the right to inspect any and all equipment involved in a warranty claim. Repair or replacement decisions are at the sole discretion of Horizon. This warranty does not cover cosmetic damage or damage due to acts of God, accident, misuse, abuse, negligence, commercial use, or modification of or to any part of the Product. This warranty does not cover damage due to improper installation, operation, maintenance, or attempted repair by anyone other than Horizon. Return of any goods by Purchaser must be approved in writing by Horizon before shipment.

DAMAGE LIMITS

HORIZON SHALL NOT BE LIABLE FOR SPECIAL, INDIRECT OR CONSEQUENTIAL DAMAGES, LOSS OF PROFITS OR PRODUCTION OR COMMERCIAL LOSS IN ANY WAY CONNECTED WITH THE PRODUCT, WHETHER SUCH CLAIM IS BASED IN CONTRACT, WARRANTY, NEGLIGENCE, OR STRICT LIABILITY. Further, in no event shall the liability of Horizon exceed the individual price of the Product on which liability is asserted. As Horizon has no control over use, setup, final assembly, modification or misuse, no liability shall be assumed nor accepted for any resulting damage or injury. By the act of use, setup or assembly, the user accepts all resulting liability.

If you as the Purchaser or user are not prepared to accept the liability associated with the use of this Product, you are advised to return this Product immediately in new and unused condition to the place of purchase.

Law: These Terms are governed by Illinois law (without regard to conflict of law principals).

SAFETY PRECAUTIONS

This is a sophisticated hobby Product and not a toy. It must be operated with caution and common sense and requires some basic mechanical ability. Failure to operate this Product in a safe and responsible manner could result in injury or damage to the Product or other property. This Product is not intended for use by children without direct adult supervision. The Product manual contains instructions for safety, operation and maintenance. It is essential to read and follow all the instructions and warnings in the manual, prior to assembly, setup or use, in order to operate correctly and avoid damage or injury.

QUESTIONS, ASSISTANCE, AND REPAIRS

Your local hobby store and/or place of purchase cannot provide warranty support or repair. Once assembly, setup or use of the Product has been started, you must contact Horizon directly. This will enable Horizon to better answer your questions and service you in the event that you may need any assistance. For questions or assistance, please direct your email to productsupport@horizonhobby.com, or call 877.504.0233 toll free to speak to a service technician.

INSPECTION OR REPAIRS

If this Product needs to be inspected or repaired, please call for a Return Merchandise Authorization (RMA). Pack the Product securely using a shipping carton. Please note that original boxes may be included, but are not designed to withstand the rigors of shipping without additional protection. Ship via a carrier that provides tracking and insurance for lost or damaged parcels, as **Horizon is not responsible for merchandise until it arrives and is accepted at our facility**. A Service Repair Request is available at www.horizonhobby.com on the "Support" tab. If you do not have internet access, please include a letter with your complete name, street address, email address and phone number where you can be reached during business days, your RMA number, a list of the included items, method of payment for any non-warranty expenses and a brief summary of the problem. Your original sales receipt must also be included for warranty consideration. Be sure your name, address, and RMA number are clearly written on the outside of the shipping carton.

WARRANTY INSPECTION AND REPAIRS

To receive warranty service, you must include your original sales receipt verifying the proof-of-purchase date. Provided warranty conditions have been met, your Product will be repaired or replaced free of charge. Repair or replacement decisions are at the sole discretion of Horizon Hobby.

NON-WARRANTY REPAIRS

Should your repair not be covered by warranty the repair will be completed and payment will be required without notification or estimate of the expense unless the expense exceeds 50% of the retail purchase cost. By submitting the item for repair you are agreeing to payment of the repair without notification. Repair estimates are available upon request. You must include this request with your repair. Non-warranty repair estimates will be billed a minimum of ½ hour of labor. In addition you will be billed for return freight. Please advise us of your preferred method of payment. Horizon accepts money orders and cashiers checks, as well as Visa, MasterCard, American Express, and Discover cards. If you choose to pay by credit card, please include your credit card number and expiration date. Any repair left unpaid or unclaimed after 90 days will be considered abandoned and will be disposed of accordingly. **Please note: non-warranty repair is only available on electronics and model engines.**

United States:

Electronics and engines requiring inspection or repair should be shipped to the following address:

Horizon Service Center
4105 Fieldstone Road
Champaign, Illinois 61822
USA

All other Products requiring warranty inspection or repair should be shipped to the following address:

Horizon Product Support
4105 Fieldstone Road
Champaign, Illinois 61822
USA

Please call 877-504-0233 with any questions or concerns regarding this product or warranty.

United Kingdom:

Electronics and engines requiring inspection or repair should be shipped to the following address:

Horizon Hobby UK
Units 1-4 Ployters Rd
Staple Tye
Harlow, Essex
CM18 7NS
United Kingdom

Please call +44 (0) 1279 641 097 or e-mail us at sales@horizonhobby.co.uk with any questions or concerns regarding this product or warranty.

Germany:

Electronics and engines requiring inspection or repair should be shipped to the following address:

Horizon Technischer Service
Hamburger Strasse 10
25335 Elmshorn
Germany

Please call +49 4121 46199 66 or e-mail us at service@horizonhobby.de with any questions or concerns regarding this product or warranty.

FCC Information

This device complies with part 15 of the FCC rules. Operation is subject to the following two conditions: (1) This device may not cause harmful interference, and (2) this device must accept any interference received, including interference that may cause undesired operation.

Caution: Changes or modifications not expressly approved by the party responsible for compliance could void the user's authority to operate the equipment.

This product contains a radio transmitter with wireless technology which has been tested and found to be compliant with the applicable regulations governing a radio transmitter in the 2.400GHz to 2.4835GHz frequency range.

CE COMPLIANCE INFORMATION FOR THE EUROPEAN UNION

The associated regulatory agencies of the following countries recognize the noted certifications for this product as authorized for sale and use.

UK	DE	DK	BG	SE	FI	FR
EE	LV	LT	PL	CZ	SK	HU
RO	SI	AT	IT	ES	PT	IE
NL	LU	MT	CY	GR		

INSTRUCTIONS FOR DISPOSAL OF WEEE BY USERS IN THE EUROPEAN UNION

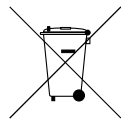

This product must not be disposed of with other waste. Instead, it is the user's responsibility to dispose of their waste equipment by handing it over to a designated collection point for the recycling of waste electrical and electronic equipment. The separate collection and recycling of your waste equipment at the time of disposal will help to conserve natural resources and ensure that it is recycled in a manner that protects human health and the environment. For more information about where you can drop off your waste equipment for recycling, please contact your local city office, your household waste disposal service or where you purchased the product.

DECLARATION OF CONFORMITY

(in accordance with ISO/IEC 17050-1)

No. HH20090630U

Product(s): Spektrum DX6i Transmitter
Item Number(s): SPM6600E, SPM66001E, SPM6620E, SPM66201E, SPMR6600E, SPMR66001E

The object of declaration described above is in conformity with the requirements of the specifications listed below, following the provisions of the European R&TTE directive 1999/5/EC:

EN 60950 Safety

EN 300-328 Technical requirements for Radio equipment.

EN 301 489-1, 301 489-17 General EMC requirements for Radio equipment

Signed for and on behalf of:
Horizon Hobby, Inc.
Champaign, IL USA
June 30, 2009

Steven A. Hall
Vice President
International Operations and Risk
Management
Horizon Hobby, Inc.

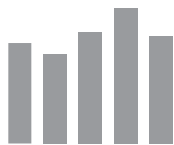

SPEKTRUM[®]

Leaders in Spread Spectrum Technology

HORIZON

H O B B Y

© 2009 Horizon Hobby, Inc.
4105 Fieldstone Road
Champaign, Illinois 61822
USA
(877) 504-0233
www.horizonhobby.com
www.spektrumrc.com

US patent 7,391,320

DSM and DSM2 are trademarks or registered trademarks of Horizon Hobby, Inc. The Spektrum trademark is used with permission of Bachmann Industries, Inc. Spektrum radios and accessories are exclusively available from Horizon Hobby, Inc.

Revised 8/09 11335.2