

 **BLADE**®

NANO S2



Instruction Manual
Bedienungsanleitung
Manuel d'utilisation
Manuale di istruzioni

SAFE®  **RTF** 

HORIZON®
H O B B Y

NOTICE

All instructions, warranties and other collateral documents are subject to change at the sole discretion of Horizon Hobby, LLC. For up-to-date product literature, visit www.horizonhobby.com or www.towerhobbies.com and click on the support or resources tab for this product.

Meaning of Special Language

The following terms are used throughout the product literature to indicate various levels of potential harm when operating this product:

WARNING: Procedures, which if not properly followed, create the probability of property damage, collateral damage, and serious injury OR create a high probability of superficial injury.

CAUTION: Procedures, which if not properly followed, create the probability of physical property damage AND a possibility of serious injury.

NOTICE: Procedures, which if not properly followed, create a possibility of physical property damage AND a little or no possibility of injury.



WARNING: Read the ENTIRE instruction manual to become familiar with the features of the product before operating. Failure to operate the product correctly can result in damage to the product, personal property and cause serious injury.

This is a sophisticated hobby product. It must be operated with caution and common sense and requires some basic mechanical ability. Failure to operate this Product in a safe and responsible manner could result in injury or damage to the product or other property. This product is not intended for use by children without direct adult supervision. Do not use with incompatible components or alter this product in any way outside of the instructions provided by Horizon Hobby, LLC. This manual contains instructions for safety, operation and maintenance. It is essential to read and follow all the instructions and warnings in the manual, prior to assembly, setup or use, in order to operate correctly and avoid damage or serious injury.

Age Recommendation: Not for children under 14 years. This is not a toy.

Safety Precautions and Warnings

- Always keep a safe distance in all directions around your model to avoid collisions or injury. This model is controlled by a radio signal subject to interference from many sources outside your control. Interference can cause momentary loss of control.
- Always operate your model in open spaces away from full-size vehicles, traffic and people.
- Always carefully follow the directions and warnings for this and any optional support equipment (chargers, rechargeable battery packs, etc.).
- Always keep all chemicals, small parts and anything electrical out of the reach of children.
- Always avoid water exposure to all equipment not specifically designed and protected for this purpose. Moisture causes damage to electronics.
- Never place any portion of the model in your mouth as it could cause serious injury or even death.
- Never operate your model with low transmitter batteries.
- Always keep aircraft in sight and under control.
- Always move the throttle fully down at rotor strike.
- Always use fully charged batteries.
- Always keep transmitter powered on while aircraft is powered.
- Always remove batteries before disassembly.
- Always keep moving parts clean.
- Always keep parts dry.
- Always let parts cool after use before touching.
- Always remove batteries after use.
- Never operate aircraft with damaged wiring.
- Never touch moving parts.

Table of Contents

Box Contents	3	Flying Checklist	11
Charging Warnings.....	4	Flying the Nano S2.....	11
Battery Charging.....	4	Troubleshooting Guide	12
Transmitter Setup Table (BNF).....	5	Drift Calibration.....	13
Transmitter Control (RTF)	7	Exploded View and Parts Listings	14
Installing the Flight Battery	7	Optional Parts	15
Transmitter and Receiver Binding.....	8	Limited Warranty	16
Control Tests.....	8	Warranty and Service Contact Information ...	17
Understanding the Primary Flight Controls	9	FCC Information.....	18
SAFE® Technology.....	10	IC Information	18
Flight Modes.....	10	Compliance Information	
Panic Recovery	11	for the European Union	18
First Flight Preparation.....	11		

Specifications

Length	200mm	Main Rotor Diameter	197mm
Height	79mm	Tail Rotor Diameter	40mm
Flying Weight	32g	<i>Visit www.bladehelis.com to register your helicopter</i>	

	Components	RTF	BNF
Airframe	Blade Nano S2	Included	Included
Motors	Brushed	Installed	Installed
Flybarless Unit	3-in-1 Control Unit with SAFE® technology	Installed	Installed
Battery	150mAh 1S 3.7V 45C Li-Po Battery	Included	Included
Charger	1S USB Li-Po Charger, 300mA	Included	Included
Transmitter	DSM2®/DSMX® Compatible Transmitter	MLP6DSM Included	Required
Transmitter Batteries	4 AA	Included	Required

Box Contents

- Blade Nano S2
- 150mAh 1S 3.7V 45C Li-Po Battery (EFLB1501S45)
- 1S USB Li-Po Charger, 300mA (EFLC1008)
- MLP6DSM Transmitter (RTF Only)
- 4 AA Batteries (RTF Only)

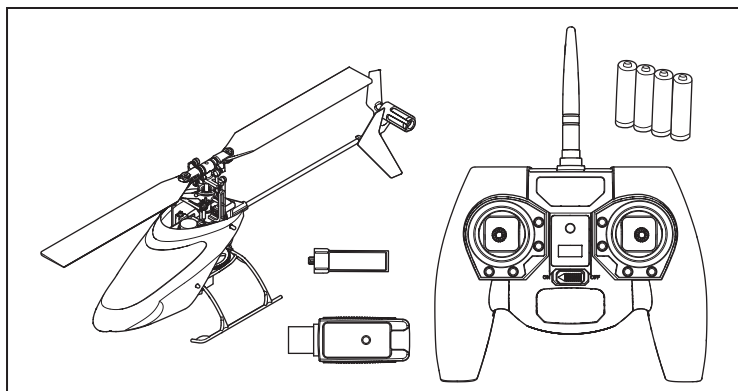

USB Charging Warnings

The Battery Charger (EFLC1008) included with your hovercraft has been designed to safely charge the Li-Po battery.



WARNING: Failure to exercise caution while using this product and comply with the following warnings could result in product malfunction, electrical issues, excessive heat, FIRE, and ultimately injury and property damage.

- **NEVER LEAVE CHARGING BATTERIES UNATTENDED.**
- **NEVER CHARGE BATTERIES OVERNIGHT.**
- Never attempt to charge dead, damaged or wet battery packs.
- Never attempt to charge a battery pack containing different types of batteries.
- Never allow children under 14 years of age to charge battery packs.
- Never charge batteries in extremely hot or cold places or place in direct sunlight.
- Never charge a battery if the cable has been pinched or shorted.
- Never connect the charger if the power cable has been pinched or shorted.
- Never attempt to dismantle the charger or use a damaged charger.
- Always use only rechargeable batteries designed for use with this type of charger.
- Always inspect the battery before charging.
- Always keep the battery away from any material that could be affected by heat.

- Always monitor the charging area and have a fire extinguisher available at all times.
- Always end the charging process if the battery becomes hot to the touch or starts to change form (swell) during the charge process.
- Always connect the positive leads (+) and negative leads (-) correctly.
- Always disconnect the battery after charging, and let the charger cool between charges.
- Always charge in a well-ventilated area.
- Always terminate all processes and contact Horizon Hobby if the product malfunctions.
- Charge only rechargeable batteries. Charging non-rechargeable batteries may cause the batteries to burst, resulting in injury to persons and/or damage to property.
- The USB outlet shall be installed near the equipment and shall be easily accessible.



CAUTION: Always ensure the battery you are charging meets the specifications of this charger. Not doing so can result in excessive heat and other related product malfunctions, which can lead to user injury or property damage. Please contact Horizon Hobby or an authorized retailer with compatibility questions.



CAUTION: If at any time during the charge process the battery pack becomes hot or begins to puff, disconnect the battery immediately and discontinue the charge process as batteries can cause fire, collateral damage and injuries.

Battery Charging

Your aircraft comes with a 1S 3.7V DC Li-Po battery charger and 1S 3.7V 150mAh 45C Li-Po battery. Refer to the charging warnings. It is recommended to charge the battery pack while you are inspecting the aircraft. The flight battery will be required to confirm proper aircraft operation in future steps.

NOTICE: Charge only batteries that are cool to the touch and are not damaged. Look at the battery to make sure it is not damaged e.g., swollen, bent, broken or punctured.

1. Insert the charger into a USB port. The charger only uses power from the USB port, it will not connect to your computer. USB power supplies, such as those used to charge cellular phones, can also be used.
2. Slide the battery into the slot on the charger and press it into the charge jack/connector located at the bottom of the slot. The end cap of the battery is specifically designed to allow the battery to fit into the slot one way (usually with the label on the battery facing outward) to prevent reverse polarity connection, however, check for proper alignment and polarity.
3. Always disconnect the flight battery from the

charger immediately upon completion of charging.



CAUTION: Only use chargers specifically designed to charge the included Li-Po battery. Failure to do so could result in fire, causing injury or property damage.



CAUTION: Never exceed the recommended charge rate.

LED Indications

When you make the connection successfully, the LED on the charger turns solid red, indicating charging has begun. Charging a fully discharged (not over-discharged) 150mAh battery takes approximately 30–40 minutes. The light goes out when the charge is complete.

Solid Red: Charging
OFF: Max Charge

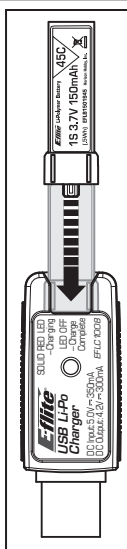

CAUTION: Once charging is complete, immediately remove the battery. Never leave a battery connected to the charger.

Transmitter Setup Table (BNF)

DX6i

SETUP LIST		ADJUST LIST						
Model Type	HELI	TRAVEL ADJ		D/R & Expo				
Swash Type	1 servo 90	Channel	Travel	Chan	Sw Pos	D/R	Expo	
REVERSE		THRO	100/100	AILE	0	100	0	
Channel	Direction	AILE	100/100		1	100	0	
THRO	N	ELEV	100/100	ELEV	0	100	0	
AILE	N	RUDD	100/100		1	100	0	
ELEV	N	GYRO	100/100	RUDD	0	100	0	
RUDD	N	PITC	100/100		1	100	0	
GYRO	N	Throttle Curve			Pitch Curve			
PITC	R	Switch Pos (F Mode)	Pos 1	Pos 2	Pos 3	Pos 4	Pos 5	
Modulation Type		NORM	0	25	50	75	100	
AUTO DSMX-ENABLE		STUNT	100	100	100	100	100	
D/R COMBI		HOLD	0					
D/R SW	AILE	Mixing			GYRO			
Timer		GYRO->GYRO	ACT					
Down Timer	4:00	Rate	D-80%	U+0%				
Switch	THR CUT	SW	GYRO	TRIM - INH				
Rate		0	90%	NORM	0			
Switch		1	15%	STUNT	1			

Panic Mode Operation

Gyro Switch: Pos 0 = Panic Mode Off, Pos 1 = Panic Mode On

DX7s, DX8

SYSTEM SETUP		FUNCTION LIST					
Model Type	HELI	Servo Setup					
Swash Type	1 servo Normal	Chan	Travel	Reverse	Chan	Travel	Reverse
F-Mode Setup		THR	100/100	Normal	GER	100/100	Normal
Flight Mode	F Mode	AILE	100/100	Normal	PIT	100/100	Normal
Hold	Hold	ELE	100/100	Normal	AX2	100/100	Normal
SW Select		RUD	100/100	Normal	Throttle Curve		
Trainer	Aux 2	D/R & Expo		Switch Pos (F Mode)			
F Mode	Gear	Chan	Switch Pos (Ail D/R)	D/R	Expo	DX7s	DX8
Gyro	INH	AILE	DX7s	DX8	D/R	Pt 1	Pt 2
Mix	INH		0	1	100/100	0	Pt 3
Hold	INH	1	2	100/100	0	Pt 5	
Knob	INH	2	1	100/100	0		
Frame Rate		ELEV	0	1	100/100	0	
22ms		1	2	100/100	0		
DSMX		RUDD	0	1	100/100	0	
		1	2	100/100	0		
		Gyro					
		INH					
		Mixing					
		Channels	AUX2 > GER				
		Rate	100%	20%			
		Offset	100%				
		Trim	INH				
		Position	N	I	H	M	
		Throttle Cut					
		Throttle 0%					
		Pitch Curve					
		Switch Pos (F Mode)	DX7s				
		DX7s	DX8	Pt 1	Pt 2	Pt 3	Pt 4
		N	N	0	25	50	75
		1	1	0	25	75	80
		2	100	100	100	100	100
		Timer					
		Mode	Count Down				
		Time	4:00 Tone				
		Start	Throttle Out				
		Over	25%				

Panic Mode Operation

Trainer/Bind Button
Pressed =
Panic Mode On
Released =
Panic Mode Off

DX6

SYSTEM SETUP		FUNCTION LIST										
Model Type	HELI	Servo Setup										
Swash Type	Normal	Chan	Travel	Reverse	Chan	Travel	Reverse					
F-Mode Setup		THR	100/100	Normal	RUD	100/100	Normal					
Switch 1	Switch B	AIL	100/100	Normal	GER	100/100	Normal					
Throttle Cut	-130%	ELE	100/100	Normal	PIT	100/100	Normal					
Channel Assign		D/R & Expo			Throttle Curve							
Channel Input		Chan	Sw (F) Pos	D/R	Expo	Sw (B) Pos	Pt 1	Pt 2	Pt 3	Pt 4	Pt 5	
1 Throttle	Throttle	AILE	0	100/100	0	N	0	25	50	75	100	
2 Aileron	Aileron		1	100/100	0	1	0	25	50	75	100	
3 Elevator	Elevator	ELEV	0	100/100	0	2	100	100	100	100	100	
4 Rudder	Rudder		1	100/100	0	HOLD	0	0	0	0	0	
5 Gear	Switch B	RUDD	0	100/100	0	Pitch Curve						
6 AUX 1	INH		1	100/100	0	Sw (B) Pos	Pt 1	Pt 2	Pt 3	Pt 4	Pt 5	
7 AUX 2		Mixing					N	0	25	50	75	100
Frame Rate		GER -> GER					1	0	25	50	75	100
22ms		Rate	100%	100%								
DSMX		Offset	20%									
		Switch	Switch I									
							2	0	25	50	75	100
							HOLD	0	25	50	75	100
							Timer					
							Mode	Count Down				
							Time	4:00				
							Start	Throttle Out				
							Over	25%				
							One Time	Inhibit				

Panic Mode Operation*Bind / I Button*

Pressed = Panic Mode On

Released = Panic Mode Off

DX7G2, DX8e, DX8G2, DX9, iX12, DX18, DX20

SYSTEM SETUP		FUNCTION LIST										
Model Type	HELI	Servo Setup										
Swash Type	Normal	Chan	Travel	Reverse	Chan	Travel	Reverse					
F-Mode Setup		THR	100/100	Normal	PIT	100/100	Normal					
Switch 1	Switch B	AIL	100/100	Normal	AX2	100/100	Normal					
Switch 2	Inhibit	ELE	100/100	Normal	AX3	100/100	Normal					
Throttle Cut	-130%	RUD	100/100	Normal	AX4	100/100	Normal					
Channel Assign		GER	100/100	Normal	Throttle Curve							
Channel Input		D/R & Expo			Sw (B) Pos	Pt 1	Pt 2	Pt 3	Pt 4	Pt 5		
1 Throttle	INH	AILE	0	100/100	0	N	0	25	50	75	100	
2 Aileron	INH		1	100/100	0	1	0	25	50	75	100	
3 Elevator	INH		2	100/100	0	2	100	100	100	100	100	
4 Rudder	INH	ELEV	0	100/100	0	HOLD	0	0	0	0	0	
5 Gear	Switch B		1	100/100	0	Pitch Curve						
6 AUX 1	INH	RUDD	2	100/100	0	Sw (B) Pos	Pt 1	Pt 2	Pt 3	Pt 4	Pt 5	
7 AUX 2			0	100/100	0	N	0	25	50	75	100	
Frame Rate		Mixing					1	0	25	50	75	100
22ms		GER -> GER					2	0	25	50	75	100
DSMX		Rate	100%	100%								
		Offset	20%									
		Switch	Switch I									
							HOLD	0	25	50	75	100
							Timer					
							Mode	Count Down				
							Time	4:00				
							Start	Throttle Out				
							Over	25%				
							One Time	Inhibit				

Panic Mode Operation*Bind / I Button*

Pressed = Panic Mode On

Released = Panic Mode Off

Transmitter Control (RTF)

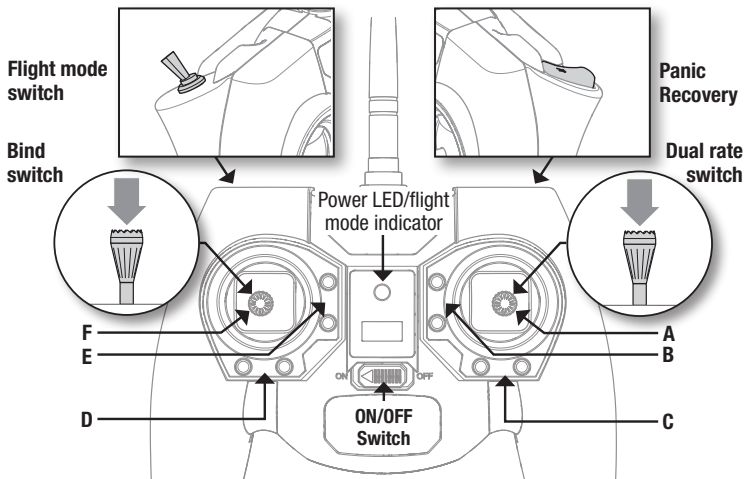

When pressed down, trim buttons make a sound that increases or decreases in pitch at each pressing. The middle or neutral trim position is heard as a middle tone in the pitch range of the sounds. The end of the control range is sounded by a series of beeps.

	A	B	C	D	E	F
Mode 1	Aileron (Left/Right) Throttle (Up/Down)	Throttle Trim	Aileron Trim	Rudder Trim	Elevator Trim	Rudder (Left/Right) Elevator (Up/Down)
Mode 2	Aileron (Left/Right) Elevator (Up/Down)	Elevator Trim	Aileron Trim	Rudder Trim	Throttle Trim	Rudder (Left/Right) Throttle (Up/Down)

Dual Rate Selection

The control sensitivity can be changed by pressing and releasing the right control stick. The LED on the transmitter will show solid for high sensitivity (default) and flashing for low sensitivity.

Installing the Flight Battery

1. Lower the throttle and throttle trim to the lowest settings.
2. Power on the transmitter.
3. Install the flight battery in the battery holder. Connect the battery cable to the 3-in-1 control unit.

NOTICE: Do not allow the helicopter to move until the blue LED on the 3-in-1 control unit is solid.

NOTICE: Always disconnect the Li-Po battery from the 3-in-1 control unit of the aircraft when not flying. Failure to do so may result in over discharge.

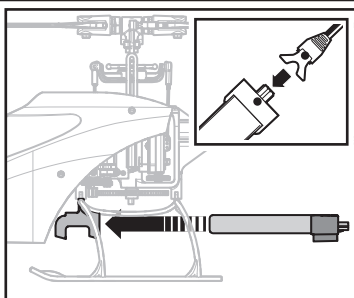

Transmitter and Receiver Binding

Binding is the process of programming the receiver of the control unit to recognize the GUID (Globally Unique Identifier) code of a single specific transmitter. You need to 'bind' your chosen Spektrum™ DSM2®/DSMX® technology equipped aircraft transmitter to the receiver for proper operation.

If you purchased an RTF model, the transmitter is bound to the model at the factory.

If for any reason you need to re-bind your Nano S2 to the MLP6DSM, follow the directions below:

Binding Procedure for the MLP6DSM (RTF)

1. Disconnect the flight battery from the helicopter.
2. Power off the transmitter and move all switches to the 0 position.
3. Connect the flight battery to the helicopter. The 3-in-1 Control unit LED flashes after 5 seconds.
4. Push and hold the bind/panic button/trigger and hold the rudder control stick to full left while powering on the transmitter.
5. Release the bind/panic button/trigger. Continue to hold the rudder control stick to full left until the LED on the 3-in-1 control unit is solid.
6. Release the rudder control stick.
7. Disconnect the flight battery and power the transmitter off.

NOTICE: If the swashplate moves up and down when the trainer switch is moved, the helicopter is in computer transmitter mode. Repeat the binding procedure.

To bind your Nano S2 to your chosen transmitter, follow the directions below:

Binding Procedure for Computer Radios (BNF)

1. Disconnect the flight battery from the helicopter.
2. Power off the transmitter and move all switches to the 0 position.
3. Connect the flight battery to the helicopter. The 3-in-1 Control unit LED flashes after 5 seconds.
4. Push the bind switch/button while powering on the transmitter.
5. After 2–3 seconds, release the bind switch/button.
6. Move the rudder control stick to full right. Continue to hold the rudder control stick to full right until the blue LED on the 3-in-1 control unit is solid.
7. Release the rudder control stick.
8. Disconnect the flight battery and power the transmitter off.

NOTICE: The throttle will not arm if the transmitter's throttle control is not put at the lowest position and the stunt mode switch is not in the 0 position.

If you encounter problems, refer to the troubleshooting guide for other instructions. If needed, contact the appropriate Horizon Hobby Product Support office.

Control Tests

Ensure the throttle hold is ON when doing the direction control tests. Test the controls prior to the first flight to ensure the servos, linkages and parts operate correctly.

If the controls do not react as shown in the illustrations below, confirm the transmitter is programmed correctly.

Elevator

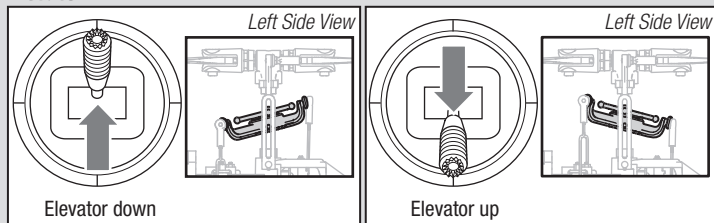

Aileron

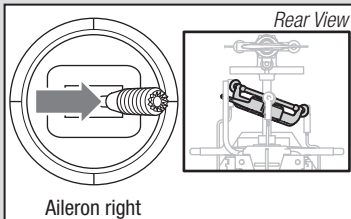
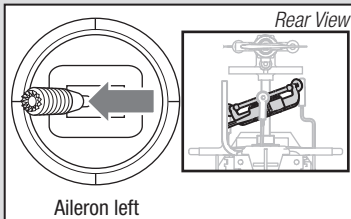

Collective Pitch

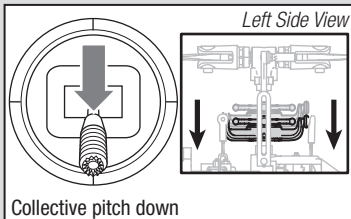
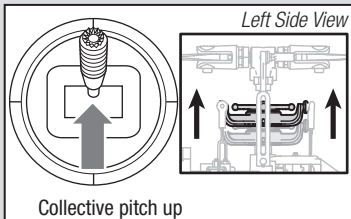

Understanding the Primary Flight Controls

If you are not familiar with the controls of your Nano S2, take a few minutes to familiarize yourself with them before attempting your first flight.

Throttle

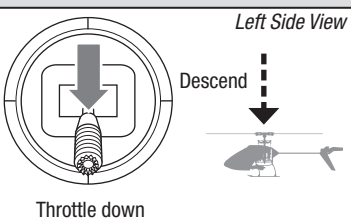
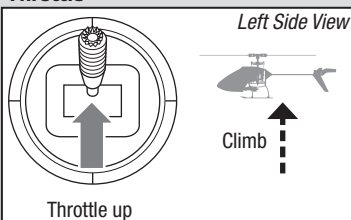

Rudder

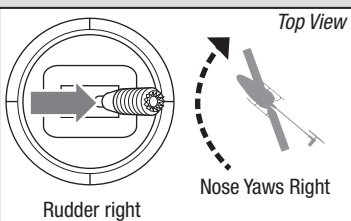
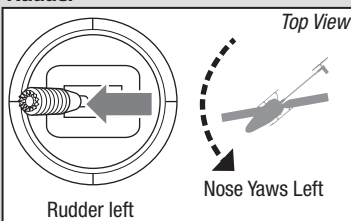

Elevator

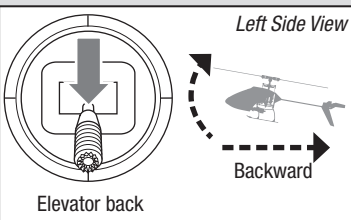
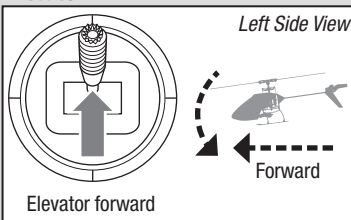

Aileron

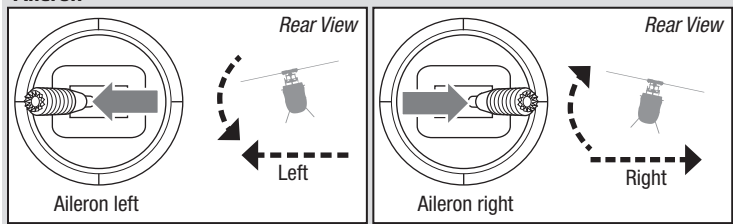

Flight Modes

The Nano S2 RTF comes with the Blade MLP6DSM transmitter. This transmitter has a flight mode switch that lets the pilot change among the following flight modes.

Throttle Hold (switch position 0)

Throttle hold is used to turn off the helicopter motors if the helicopter is out of control, in danger of crashing or both. Activate throttle hold anytime the helicopter is in danger to reduce the chance of damaging the helicopter in a crash.

Stability Mode Z (switch position 1)

- Stability Mode is typically preferred by pilots with less experience flying collective pitch helicopters.
- The helicopter will limit the bank angle, even with full control input, and return the aircraft to a level flight attitude when the controls are released.
- The yaw rate is slowed for ease of control.
- The Panic Recovery button returns the helicopter to upright, level attitude.
- The throttle mode is normal.
Low throttle stick position = 0% throttle.
- The helicopter uses the stability sensor to help control ascent and descent rates.

3D Mode (switch position 2)

- 3D Mode is intended for pilots with experience with collective pitch helicopters.

- The model will NOT return to a level attitude position when you release the controls.
- The helicopter has no bank angle limit.
- Both the cyclic and yaw controls are at fast, aerobatic rate.
- The Panic Recovery button returns the helicopter to a level attitude, either upright or inverted, whichever is closer.
- The throttle mode is "Idle up." The motor remains at a constant speed, regardless of the throttle stick position. The throttle stick controls the pitch of the main rotor blades.

If you choose to use a computer radio, programmed as shown in the *Transmitter Setup Table* section, the flight mode switch gives the pilot the choice between the following flight modes:

Stability Mode Z (switch position 0) as previously described.

Stability Mode (switch position 1)

- Stability Mode shares the same characteristics as Stability Z mode but without the stability sensor to help control the ascent and descent rates.

3D Mode (switch position 2) as previously described.

Activate **Throttle Hold** with the *Hold switch*.

Panic Recovery

If you get into distress while flying in any mode, push and hold the Bind/Panic Switch and move the control sticks to their neutral position. SAFE technology will immediately return the aircraft to an upright level attitude, if the aircraft is at a sufficient height with no obstacles in its path. Return the collective stick to 50% and release the Panic Switch to turn off Panic Recovery and return to the current flight mode.

- This mode is intended to provide the pilot with the confidence to continue to improve their flight skills.

- Move the collective stick to 50% and return all other transmitter controls to neutral for the quickest recovery.
- Once the model has reached a level upright attitude the negative collective is reduced preventing the user from pushing the model into the ground.

NOTICE: Before releasing the panic switch, make sure the collective stick has been returned to the 50% position. Once the panic switch has been released, full negative collective becomes available, which could cause the Nano S2 to descend rapidly.

First Flight Preparation

- Remove and inspect contents
- Begin charging the flight battery
- Program your computer transmitter (BNF)
- Install the flight battery in the helicopter (once it has been fully charged)
- Bind your transmitter (BNF)
- Familiarize yourself with the controls
- Find a suitable area for flying

Flying Checklist

- Always turn the transmitter on first**
- Plug the flight battery into the lead from the ESC
- Allow the receiver and ESC to initialize and arm properly
- Fly the model
- Land the model
- Unplug the flight battery from the ESC
- Always turn the transmitter off last**

Flying the Nano S2

Consult your local laws and ordinances before choosing a location to fly your aircraft. We recommend flying your aircraft outside in calm winds or inside a large gymnasium. Always avoid flying near houses, trees, wires and buildings. You should also be careful to avoid flying in areas where there are many people, such as busy parks, schoolyards or soccer fields.

It is best to fly from a smooth flat surface as this will allow the model to slide without tipping over. Keep the helicopter approximately 2 ft (600mm) above the ground. Keep the tail pointed toward you during initial flights to keep the control orientation consistent. Releasing the stick in Beginner Mode will allow the helicopter to level itself and activating the Panic Recovery button will level the helicopter quickly. If you become disoriented while in Beginner Mode, slowly lower the throttle stick to land softly. During initial flights, only attempt takeoff, landing and hovering in one spot.

Takeoff

Place the model onto a flat, level surface free of obstacles and walk back 30 feet (10 meters). Slowly increase the throttle until

the model is approximately 2 ft. (600mm) off the ground and check the trim so the model flies as desired. Once the trim is adjusted, begin flying the model.

Hovering

Making small corrections on the transmitter, try to hold the helicopter in one spot. If flying in calm winds, the model should require almost no corrective inputs. After moving the cyclic stick and returning it to center the model should level itself. The model may continue to move due to inertia. Move the cycle stick in the opposite direction to stop the movement.

After you become comfortable hovering, you can progress into flying the model to different locations, keeping the tail pointed towards you at all times. You can also ascend and descend using the throttle stick. Once you're comfortable with these maneuvers, you can attempt flying with the tail in different orientations. It is important to keep in mind that the flight control inputs will rotate with the helicopter, so always try to picture the control inputs relative to the nose of the helicopter. For example, forward will always drop the nose of the helicopter.

Low Voltage Cutoff (LVC)

LVC decreases the power to the motors when the battery voltage gets low. When the motor power decreases and the red LED on the ESC flashes, land the aircraft immediately and recharge the flight battery. LVC does not prevent the battery from over-discharge during storage.

NOTICE: Repeated flying to LVC will damage the battery.

Landing

To land, slowly decrease the throttle while in a low-level hover. After landing, disconnect and remove the battery from the aircraft after use to prevent trickle discharge. Fully charge your battery before storing it. During storage, make sure the battery charge does not fall below 3V per cell.

Troubleshooting Guide

Problem	Possible Cause	Solution
Helicopter will not initialize	Throttle at high position	Reset controls with throttle stick and throttle trim at center or lowest setting
	Switches not in normal position	Set flight mode to OFF/0 and exit throttle hold
	Pitch or throttle servo reversing improperly configured	Reset servo reversing <i>Refer to "Programming your Transmitter"</i>
Helicopter will not spool up	Throttle hold on	Turn off HOLD with throttle low and trim centered or low. <i>Refer to "Throttle Hold"</i>
	Low battery voltage	Completely recharge flight battery
Motor power decreases during flight	Receiver uses default soft Low Voltage Cutoff (LVC)	Recharge the flight battery or replace if the battery performance is poor
Cannot turn off throttle hold	Stunt Mode switch still on	Set flight mode to OFF/ 0 and exit throttle hold
	Throttle not at low position	Reset controls with throttle stick and throttle trim at center or lowest setting
Powers off when flying upside down (inverted)	Flight mode is set to Beginner Mode	Switch the flight mode switch to Intermediate or Experienced Mode before flying inverted
Will not bind properly to non-computer radio	Helicopter binds differently to non-computer radios	Release bind button/ switch after applying left rudder. Do not hold the bind button/ switch after applying left rudder
Poor tail authority	Tail boom is cracked	Replace tail boom
	The tail rotor blade is warped or bent	Twist rotor blade back into position or replace
Climb out rate is greatly reduced	Main gear has slipped on the main shaft	Push main gear back into position

Problem	Possible Cause	Solution
LED on receiver flashes rapidly and aircraft will not bind to transmitter (during binding)	Transmitter is too near aircraft during binding process	Power off transmitter, move transmitter a larger distance from aircraft, disconnect and reconnect flight battery to aircraft and follow binding instructions
	Bind switch or button was not held while transmitter was powered on	Power off transmitter and repeat bind process
	Aircraft or transmitter is too close to large metal object, wireless source or another transmitter	Move aircraft and transmitter to another location and attempt binding again
LED on receiver flashes rapidly and aircraft will not respond to transmitter (after binding)	Less than a 5-second wait between first powering on transmitter and connecting flight battery to aircraft	Leaving transmitter on, disconnect and reconnect flight battery to aircraft
	Aircraft is bound to a different model memory (<i>ModelMatch™</i> radios only)	Select correct model memory on transmitter and disconnect and reconnect flight battery to aircraft
	Flight battery/transmitter battery charge is too low	Replace/recharge batteries
	Transmitter may have been bound to a different model (or with a different DSM® Protocol)	Select the right transmitter or bind to the new one
Aircraft or transmitter is too close to large metal object, wireless source or another transmitter	Move aircraft and transmitter to another location and attempt connecting again	
Helicopter vibrates or shakes in flight	Damaged rotor blades, spindle or blade grips	Check main rotor blades and blade grips for cracks or chips. Replace damaged parts. Replace bent spindle

Drift Calibration

The helicopter has been calibrated in the factory before shipment, but it is possible that a crash will cause mechanical distortion of the frame, resulting in a slight drift in Stability mode. In this situation, please follow the calibration procedure.

Before beginning the calibration procedure, fully charge the flight battery and ensure the helicopter and transmitter are bound properly, per the binding instructions.

To calibrate the Blade Nano S2:

1. After initialization, move the transmitter sticks to the bottom, outside corners, as shown in the illustration.

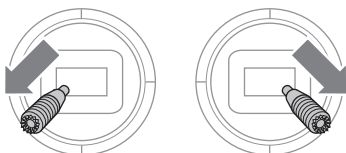

When the red and blue LEDs on the main control board flash slowly, calibration mode is active.

2. Release the sticks.
3. Slowly advance the throttle to bring the helicopter into a low hover. The red and blue LEDs flash rapidly to indicate the calibration process has begun. Hold the hover for approximately 15 seconds, using as little control input as possible to keep the helicopter steady.
4. Land the helicopter by slowly lowering the throttle.
5. After Landing, press the bind/panic button to complete the calibration process. The LED will show solid blue.

Exploded View and Parts Listings

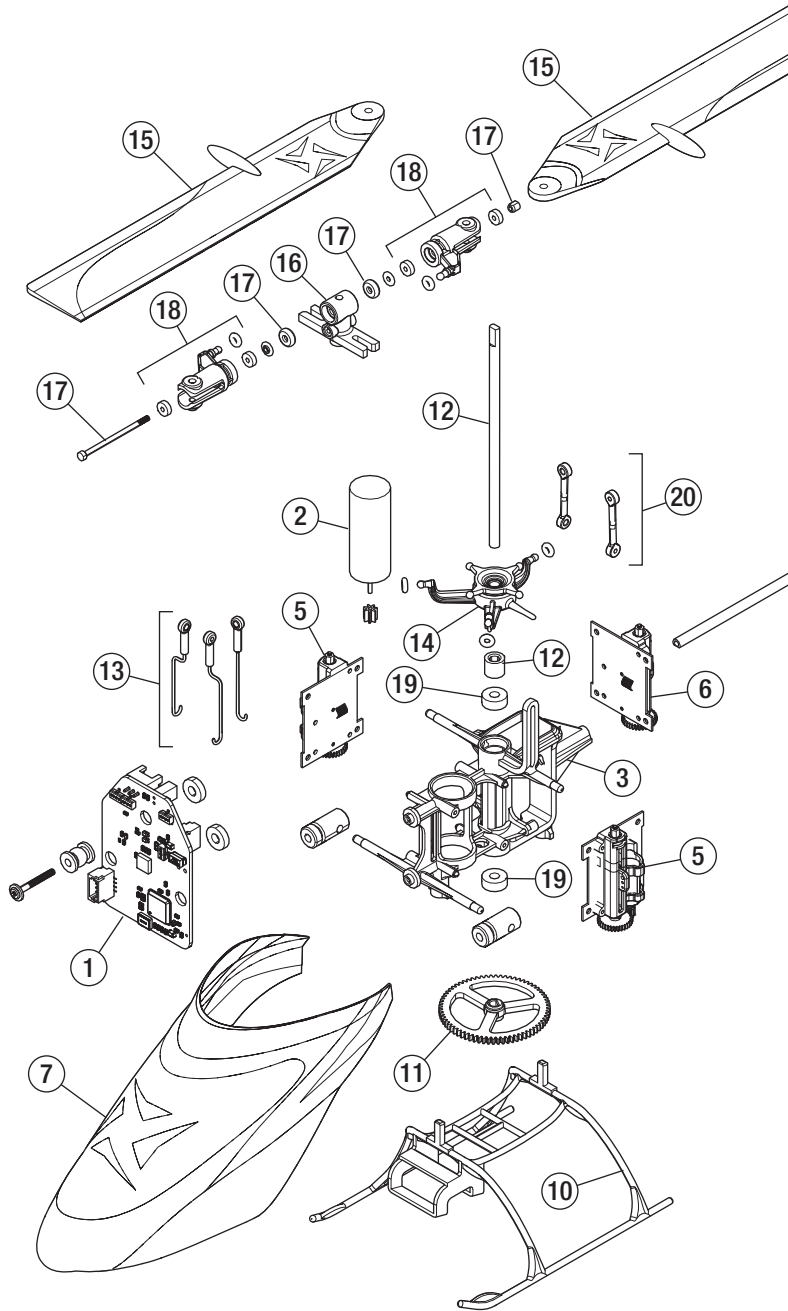

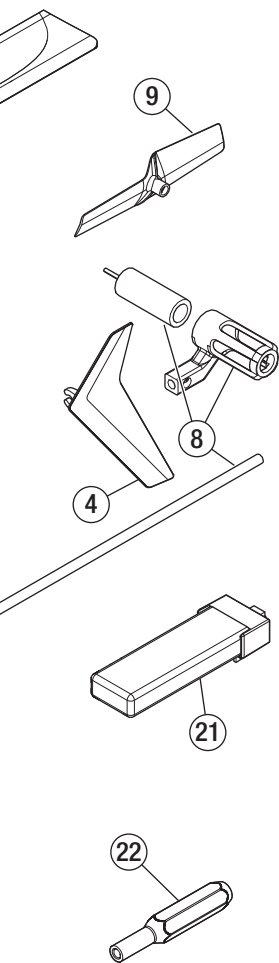

	Part #	Description
1	BLH1301	Nano S2 Main board
2	BLH2402	nCP S Main motor
3	BLH1302	Nano S2 Main plastic frame
4	BLH1304	Nano S2 Tail Fin
5	SPMSH2027L	DSV40LBC-35 Servo *1
6	SPMSH2028L	DSV40LBC-50 Servo *1
7	BLH1303	Nano S2 Canopy
8	BLH3302	Nano CP X Tail Boom and Motor
9	BLH3603	Tail Rotor
10	EFLH3004	Landing Skid & Battery mount
11	BLH3306	Main Gear
12	BLH3307	Carbon Fiber Main Shaft with Collar & Hardware
13	BLH3308	Servo Pushrod set with Ball Links
14	BLH3309	Complete Precision Swashplate
15	BLH1305	Main Rotor Blade Set: Nano S2
16	BLH3312	Main Rotor Hub with Hardware
17	BLH3313	Feathering Spindle with O-rings and Hardware
18	BLH3314	Main Blade Grips with Bearings
19	BLH3315	2 x 5 x 2 Bearings (2)
20	BLH3322	Rotor Head Linkage Set (4)
21	EFLB1501S45	1-Cell 3.7v 45C LiPo Battery
22	BLH3324	Spindle Tool Set
	BLH3323	Hardware Set
	EFLC1008	1s USB LiPo charger, 300mAh
	SPM6836	Replacement Servo Mechanics
	EFLRMLP6H	MPL6DSM Heli SAFE transmitter
	BLH3021	Canopy Mounting Grommets (8)
	BLH2507	Bearing m2.5x6x1.8 Apache AH-64
	BLH2508	Bearing m2.5x6x2.5 Apache AH-64

Optional Parts

Part #	Description
	DX6i DSMX 6-Channel Transmitter Only
	DX7s DSMX 7-Channel Transmitter Only
	DX6 DSMX 6-Channel Transmitter Only
	DX7 DSMX 7-Channel Transmitter Only
	DX8 DSMX 8-Channel Transmitter Only
	DX9 DSMX 9-Channel Transmitter Only
	DX18 DSMX 18-Channel Transmitter Only

Limited Warranty

What this Warranty Covers

Horizon Hobby, LLC, (Horizon) warrants to the original purchaser that the product purchased (the "Product") will be free from defects in materials and workmanship at the date of purchase.

What is Not Covered

This warranty is not transferable and does not cover (i) cosmetic damage, (ii) damage due to acts of God, accident, misuse, abuse, negligence, commercial use, or due to improper use, installation, operation or maintenance, (iii) modification of or to any part of the Product, (iv) attempted service by anyone other than a Horizon Hobby authorized service center, (v) Product not purchased from an authorized Horizon dealer, (vi) Product not compliant with applicable technical regulations, or (vii) use that violates any applicable laws, rules, or regulations.

OTHER THAN THE EXPRESS WARRANTY ABOVE, HORIZON MAKES NO OTHER WARRANTY OR REPRESENTATION, AND HEREBY DISCLAIMS ANY AND ALL IMPLIED WARRANTIES, INCLUDING, WITHOUT LIMITATION, THE IMPLIED WARRANTIES OF NON-INFRINGEMENT, MERCHANTABILITY AND FITNESS FOR A PARTICULAR PURPOSE. THE PURCHASER ACKNOWLEDGES THAT THEY ALONE HAVE DETERMINED THAT THE PRODUCT WILL SUITABLY MEET THE REQUIREMENTS OF THE PURCHASER'S INTENDED USE.

Purchaser's Remedy

Horizon's sole obligation and purchaser's sole and exclusive remedy shall be that Horizon will, at its option, either (i) service, or (ii) replace, any Product determined by Horizon to be defective. Horizon reserves the right to inspect any and all Product(s) involved in a warranty claim. Service or replacement decisions are at the sole discretion of Horizon. Proof of purchase is required for all warranty claims. SERVICE OR REPLACEMENT AS PROVIDED UNDER THIS WARRANTY IS THE PURCHASER'S SOLE AND EXCLUSIVE REMEDY.

Limitation of Liability

HORIZON SHALL NOT BE LIABLE FOR SPECIAL, INDIRECT, INCIDENTAL OR CONSEQUENTIAL DAMAGES, LOSS OF PROFITS OR PRODUCTION OR COMMERCIAL LOSS IN ANY WAY, REGARDLESS OF WHETHER SUCH CLAIM IS BASED IN CONTRACT, WARRANTY, TORT, NEGLIGENCE, STRICT LIABILITY OR ANY OTHER THEORY OF LIABILITY, EVEN IF HORIZON HAS BEEN ADVISED OF THE POSSIBILITY OF SUCH DAMAGES. Further, in no event shall the liability of Horizon exceed the individual price of

the Product on which liability is asserted. As Horizon has no control over use, setup, final assembly, modification or misuse, no liability shall be assumed nor accepted for any resulting damage or injury. By the act of use, setup or assembly, the user accepts all resulting liability. If you as the purchaser or user are not prepared to accept the liability associated with the use of the Product, purchaser is advised to return the Product immediately in new and unused condition to the place of purchase.

Law

These terms are governed by Illinois law (without regard to conflict of law principals). This warranty gives you specific legal rights, and you may also have other rights which vary from state to state. Horizon reserves the right to change or modify this warranty at any time without notice.

WARRANTY SERVICES

Questions, Assistance, and Services

Your local hobby store and/or place of purchase cannot provide warranty support or service. Once assembly, setup or use of the Product has been started, you must contact your local distributor or Horizon directly. This will enable Horizon to better answer your questions and service you in the event that you may need any assistance. For questions or assistance, please visit our website at www.horizonhobby.com, submit a Product Support Inquiry, or call the toll free telephone number referenced in the Warranty and Service Contact Information section to speak with a Product Support representative.

Inspection or Services

If this Product needs to be inspected or serviced and is compliant in the country you live and use the Product in, please use the Horizon Online Service Request submission process found on our website or call Horizon to obtain a Return Merchandise Authorization (RMA) number. Pack the Product securely using a shipping carton. Please note that original boxes may be included, but are not designed to withstand the rigors of shipping without additional protection. Ship via a carrier that provides tracking and insurance for lost or damaged parcels, as Horizon is not responsible for merchandise until it arrives and is accepted at our facility. An Online Service Request is available at http://www.horizonhobby.com/content/service-center_render-service-center. If you do not have internet access, please contact Horizon Product Support to obtain a RMA number along with instructions for submitting your product for service. When calling Horizon, you will be asked to provide your complete name, street address, email address and phone number

where you can be reached during business hours. When sending product into Horizon, please include your RMA number, a list of the included items, and a brief summary of the problem. A copy of your original sales receipt must be included for warranty consideration. Be sure your name, address, and RMA number are clearly written on the outside of the shipping carton.

NOTICE: Do not ship Li-Po batteries to Horizon. If you have any issue with a Li-Po battery, please contact the appropriate Horizon Product Support office.

Warranty Requirements

For Warranty consideration, you must include your original sales receipt verifying the proof-of-purchase date. Provided warranty conditions have been met, your Product will be serviced or replaced free of charge. Service or replacement decisions are at the sole discretion of Horizon.

Non-Warranty Service

Should your service not be covered by warranty, service will be completed and payment will be required without notification or estimate of the expense unless the expense exceeds 50% of the retail purchase cost. By submitting the item for

service you are agreeing to payment of the service without notification. Service estimates are available upon request. You must include this request with your item submitted for service. Non-warranty service estimates will be billed a minimum of ½ hour of labor. In addition you will be billed for return freight. Horizon accepts money orders and cashier's checks, as well as Visa, MasterCard, American Express, and Discover cards. By submitting any item to Horizon for service, you are agreeing to Horizon's Terms and Conditions found on our website http://www.horizonhobby.com/content/service-center_render-service-center.

ATTENTION: Horizon service is limited to Product compliant in the country of use and ownership. If received, a non-compliant Product will not be serviced. Further, the sender will be responsible for arranging return shipment of the un-serviced Product, through a carrier of the sender's choice and at the sender's expense. Horizon will hold non-compliant Product for a period of 60 days from notification, after which it will be discarded.

10/15

Warranty and Service Contact Information

Country of Purchase	Horizon Hobby	Contact Information	Address
USA	Horizon Service Center (Repairs and Repair Requests)	servicecenter.horizonhobby.com/RequestForm/	2904 Research Rd Champaign, Illinois 61822 USA
	Horizon Product Support (Product Technical Assistance)	productsupport@horizonhobby.com 877-504-0233	
	Sales	websales@horizonhobby.com 800-338-4639	
EU	Horizon Technischer Service	service@horizonhobby.eu	Hanskampring 9 D 22885 Barsbüttel, Germany
	Sales: Horizon Hobby GmbH	+49 (0) 4121 2655 100	

FCC Information

FCC ID: BRWDXMTX10

FCC ID: BRWBLH1301

This device complies with part 15 of the FCC rules. Operation is subject to the following two conditions: (1) This device may not cause harmful interference, and (2) this device must accept any interference received, including interference that may cause undesired operation.



CAUTION: Changes or modifications not expressly approved by the party responsible for compliance could void the user's authority to operate the equipment.

This product contains a radio transmitter with wireless technology which has been tested and found to be compliant with the applicable regulations governing a radio transmitter in the 2.400GHz to 2.4835GHz frequency range.

Supplier's Declaration of Conformity Blade Nano CP S V2 RTF (BLH1300)

BRWDXMTX10 | BRWBLH1301



This device complies with part 15 of the FCC Rules. Operation is subject to the following two conditions: (1) This device may not cause harmful interference, and (2) this device must accept any interference received, including interference that may cause undesired operation.



CAUTION: Changes or modifications not expressly approved by the party responsible for compliance could void the user's authority to operate the equipment.

NOTE: This equipment has been tested and found to comply with the limits for a Class B digital device, pursuant to part 15 of the FCC Rules. These limits are designed to provide reasonable protection against harmful interference in a residential installation. This equipment generates, uses and can radiate radio frequency energy and, if not installed and used in accordance with the instructions, may cause harmful interference to radio communications. However, there is no guarantee that interference will not occur in a particular installation. If this equipment does cause harmful interference to radio or television reception, which can be determined by turning the equipment off and on, the user is encouraged to try to correct the interference by one or more of the following measures:

- Reorient or relocate the receiving antenna.
- Increase the separation between the equipment and receiver.
- Connect the equipment into an outlet on a circuit different from that to which the receiver is connected.
- Consult the dealer or an experienced radio/TV technician for help.

Horizon Hobby, LLC

2904 Research Rd.

Champaign, IL 61822

Email: compliance@horizonhobby.com

Web: HorizonHobby.com



IC Information

IC ID: 6175A-BRWDXMT | **IC ID:** 6175A-BLH1301

This device complies with Industry Canada license-exempt RSS standard(s). Operation is subject to the following two conditions: (1) this device may not cause interference, and (2) this device must accept any interference, including interference that may cause undesired operation of the device.

Compliance Information for the European Union



EU Compliance Statement: Horizon Hobby, LLC hereby declares that this product is in compliance with the essential requirements and other relevant provisions of the RED and EMC Directives.

A copy of the EU Declaration of Conformity is available online at:

<http://www.horizonhobby.com/content/support-render-compliance>.



Instructions for disposal of WEEE by users in the European Union

This product must not be disposed of with other waste. Instead, it is the user's responsibility to dispose of their waste equipment by handing it over to a designated collections point for the recycling of waste electrical and electronic equipment. The separate collection and recycling of your waste equipment at the time of disposal will help to conserve natural resources and ensure that it is recycled in a manner that protects human health and the environment. For more information about where you can drop off your waste equipment for recycling, please contact your local city office, your household waste disposal service or where you purchased the product.



©2019 Horizon Hobby, LLC.

Blade, the Blade logo, E-flite, the BNF logo, DSM, DSM2, DSMX, Safe, the SAFE logo, ModelMatch and the Horizon Hobby logo are trademarks or registered trademarks of Horizon Hobby, LLC.

The Spektrum trademark is used with permission of Bachmann Industries, Inc.

All other trademarks, service marks and logos are property of their respective owners. US 8,672,726.
Updated 05/19 59725.1 BLH1300 / BLH1380