

READY-TO-RUN

RR10TM BOMBER

1/10th SCALE ELECTRIC 4WD



 **axial**[®]

www.axialracing.com



CAUTIONS

 **To prevent serious personal injury and/or property damage, operate all remotely controlled models in a responsible manner as outlined herein.**

CHOOSE THE RIGHT PLACE TO OPERATE YOUR R/C MODEL.

- Do not run on public streets or highways. This could cause serious accidents, personal injuries, and/or property damage.
- Never run R/C models near people or animals.
- To avoid injury, do not run in confined spaces.
- Do not run where loud noises can disturb others, such as hospitals and residential areas.
- Never run indoors. There is a high risk of fire and/or damage.

INSPECT YOUR MODEL BEFORE OPERATION.

- Make sure that all screws and nuts are properly tightened. It is also a good idea to use removable thread lock wherever metal screws go into metal, especially for engine mounts and the engine pilot shaft.
- Always use fresh batteries for your transmitter and for your receiver to avoid losing control of the model.
- Always test the brakes and throttle before starting your engine to avoid losing control of the model.

AFTER OPERATION OF YOUR R/C MODEL

- Disconnect battery in vehicle first, then turn off transmitter, this will prevent runaways.
- Be careful when handling batteries, they will be hot after running.
- Replace any batteries that have been dented or have frayed wires, short circuits can cause fire.
- Be sure to keep your R/C model clean and free of excess dirt and grease, this will increase the life.

VORSICHT!

 **Um Verletzungen an Personen und/oder Sachschäden zu vermeiden, sollten alle ferngesteuerten Modelle sorgfältig und verantwortungsbewusst bedient werden, wie nachfolgend beschrieben.**

Wählen Sie den richtigen Platz zum Fahren

- Fahren Sie niemals auf öffentlichen Straßen. Dies könnte Verkehrsunfälle, Personen schäden oder Sachschäden verursachen.
- Fahren Sie niemals in der Nähe von anderen Personen oder Tieren.
- Fahren Sie niemals auf belebten Straßen.
- Fahren Sie nie in der Nähe von Wohnhäusern oder Krankenhäusern. Der Lärm könnte andere Personen stören.
- Fahren Sie niemals in Innenräumen. Dort könnte etwas beschädigt werden.

Überprüfen Sie Ihr Modell, bevor Sie es in Betrieb nehmen.

- Gehen Sie sicher, dass alle Schrauben und Muttern festgezogen sind. Verwenden Sie überall dort Schrauben-Sicherungslack, wo Metallschrauben in ein Metallgewinde greifen, besonders bei den Motorhaltern.
- Um Störungen zu vermeiden, benutzen Sie immer voll geladene Akkus in Ihrem Sender und Empfänger.
- Bevor Sie den Motor starten, sollten Sie immer die Funktion der Bremse und des Gashebels testen.

Nach Betrieb des RC Modells:

- Zuerst den Empfänger abdrehen, dann den Sender abdrehen um unkontrolliertes Durchgehen zu vermeiden.
- Seien Sie vorsichtig mit gebrauchten Akkus, sie können nach dem Gebrauch heiß sein.
- Ersetzen Sie Akkus/Batterien die beschädigt sind oder schadhafte Kabel aufweisen, sie können Kurzschlüsse oder Feuer verursachen.
- Halten Sie Ihr Fahrzeug sauber und entfernen Sie Schmutz und Schmierfett, damit erhöhen Sie die Lebensdauer Ihres Modells.

PRECAUTIONS

 **Afin d'éviter toutes blessures corporelles et/ou dommages environnants, veuillez procéder en toute responsabilité comme indiqué ci-dessous**

Choisir le lieu adéquat pour faire rouler votre modèle.

- Ne jamais rouler dans les rues ou sur les routes ouvertes au public. Ceci peut provoquer de graves accidents.
- Ne jamais rouler près de personnes ou d'animaux.
- Pour éviter les blessures, ne pas rouler dans des espaces confinés.
- Ne jamais rouler où le bruit peut déranger, comme aux abords des hôpitaux ou des quartiers résidentiels.
- Ne jamais rouler à l'intérieur: les gaz d'échappement sont nocifs.

Controler votre modèle avant chaque utilisation.

- Vérifier que les vis et les écrous sont bien serrés. Il est très fortement conseillé d'utiliser du frein filet pour bloquer les vis qui sont en contact avec du métal et tout particulièrement les vis du moteur.
- Toujours utiliser des batteries bien chargées pour l'émission et la réception.
- Toujours vérifier les freins et la commande des gaz avant de démarrer.

Après l'Opération De Votre Modèle de R/C

- Le virage du récepteur premier, alors virage de l'émetteur, ceci empêchera des fugitifs.
- Faire attention en contrôlant des piles, ils auront chaud après avoir couru.
- Remplacer n'importe quelles piles qui ont été cabossées ou a éraillé des fils, les court-circuits peuvent causer le feu.
- Etre sûr de garder votre modèle de R/C nettoie et libère de terre et la graisse supplémentaires, ceci augmentera la vie.

Included items / Im Baukasten enthalten / Outils inclus dans le kit

Radio control car
Ferngesteuertes Modellauto
Voiture radio-commandée

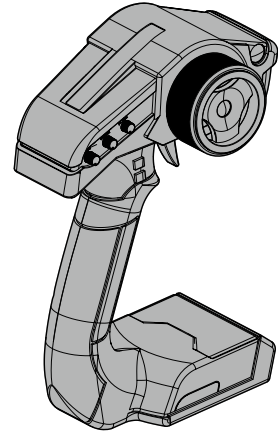
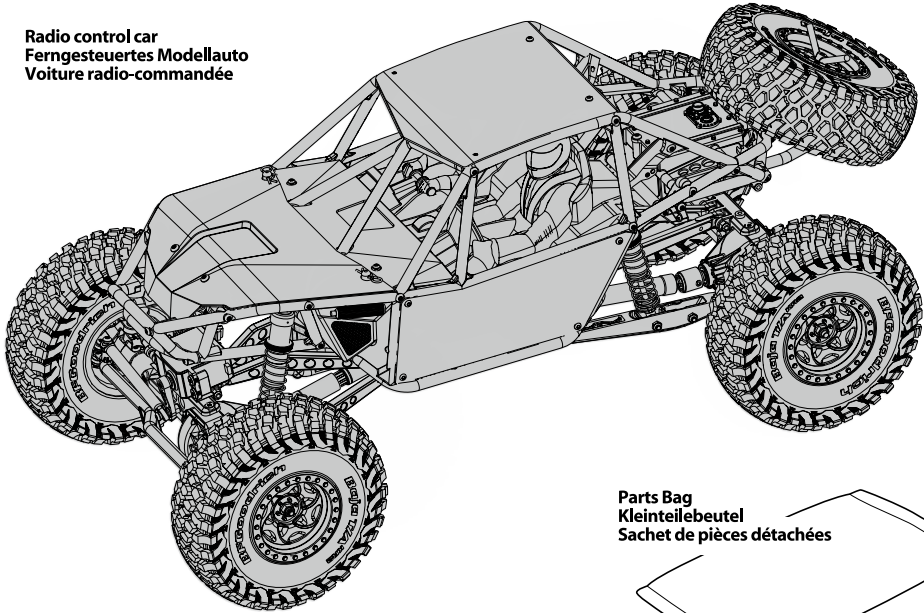

2.4GHz
Transmitter
Sender
Emetteur

Parts Bag
Kleinteilebeutel
Sachet de pièces détachées

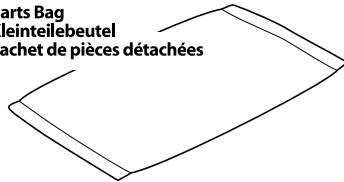

Cross wrench
Steckschlüssel
Clé à tube

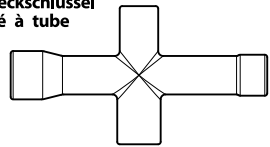

Equipment needed / Benötigtes Zubehör / Equipement nécessaire

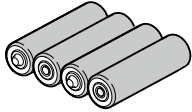

x4

4 AA Alkaline Dry Batteries.
4 St. AA Trockenbatterien.
4 piles type R6 pour votre
radio commande.

Li-Po or Ni-MH Battery Pack
Akku-Pack
Pack de batterie

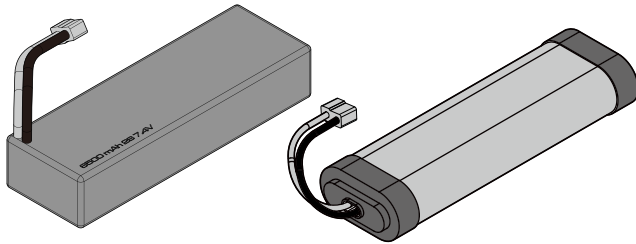

T-Style Battery Connector Required.

Charger
Ladegerät
Chargeur

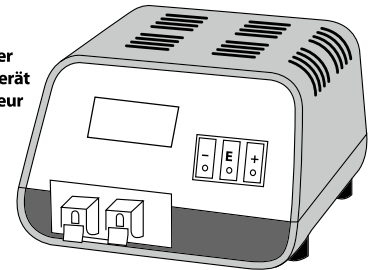

Tools Recommended / Benötigte Werkzeuge / Outillage

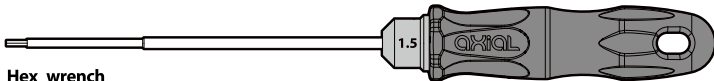

Hex wrench
Inbusschlüssel
Clé Allen

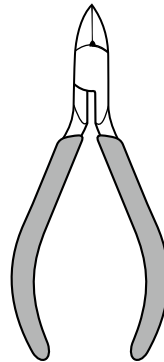
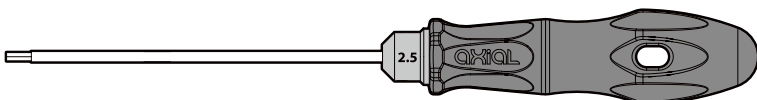
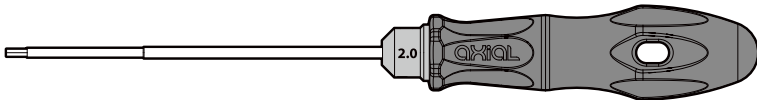

Side cutter
Seitenschneider
Pincès coupantes

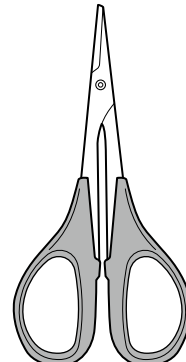

Curved scissors
Schere
Ciseaux

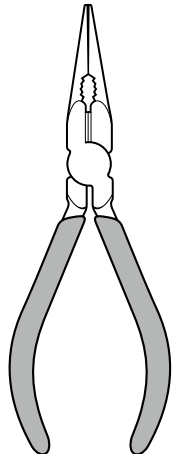

Long nose pliers
Flachzange
Pincès à becs longs

Modeling knife
Modelliermesser
Couteau de modéliste

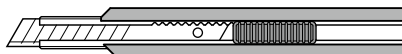

Charge your battery / Laden des Fahrakkus / Chargement de la batterie

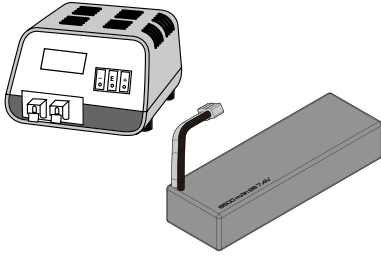

Follow the manufacturer's directions for the charger you purchased to properly charge your batteries.

Folgen Sie den Herstelleranweisungen für den Auflader Ihres gekauften, ordentlich, Ihre Batterien zu laden.

Suivre les directions de fabricants pour le chargeur votre a acheté convenablement pour charger vos piles.

Make sure charger is correct for battery type selected for use. Examples: Do NOT charge Lipo batteries with Nickel Metal Hydride charger. Do NOT charge Nickel Cadmium batteries Lipo charger.

Stellen Sie sicher, Ladegerät ist korrekt für Batterietyp zur Verwendung ausgewählt. Beispiele: Laden Sie keine Lipo-Akkus mit Nickel-Metall-Hybrid-Ladegerät. Laden Sie keine Nickel-Cadmium-Akkus Lipo Ladegerät.

Assurez-vous que le chargeur est correcte pour le type de batterie sélectionné à l'emploi. Exemples: Ne pas charger les batteries Lipo avec chargeur hydrure métallique de nickel. Ne chargez pas les batteries au nickel-cadmium Lipo chargeur.

1 Turn on the transmitter.

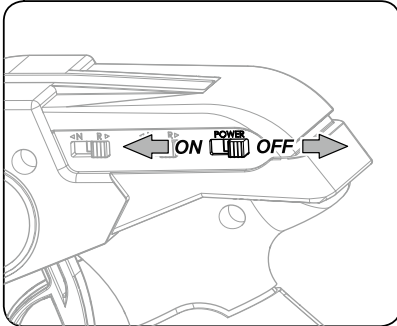

2 Connect the battery.

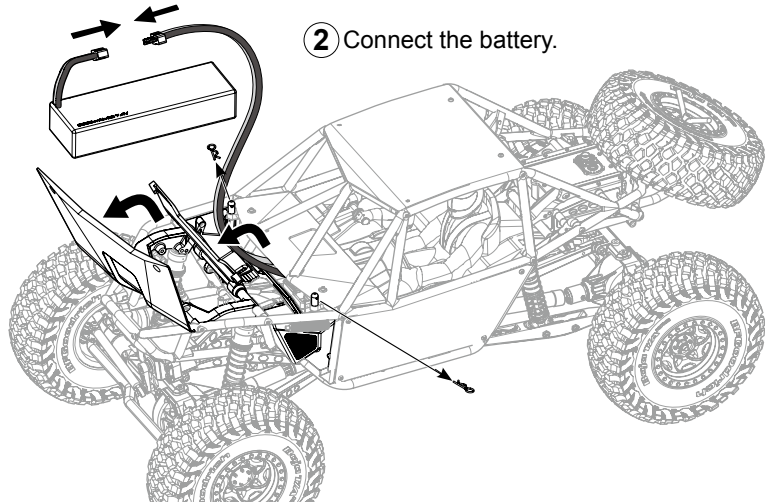

3 Install the battery

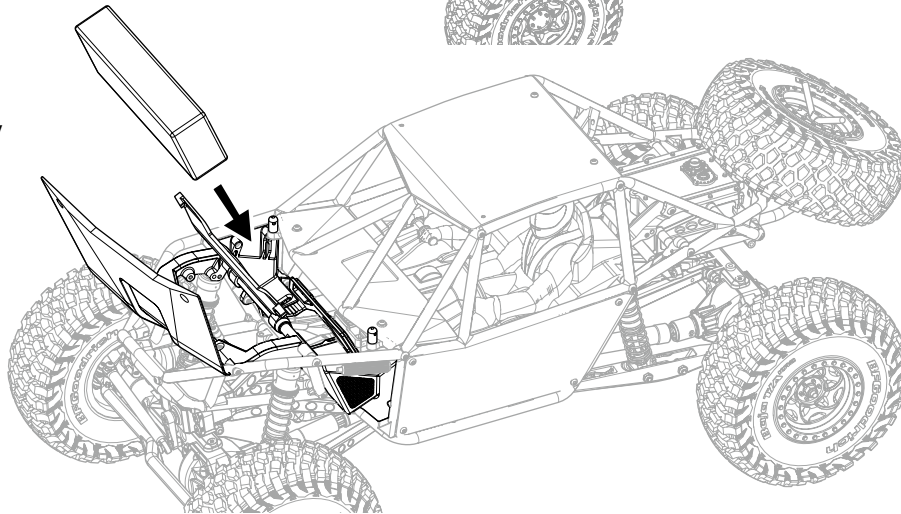

4 Close the battery tray and hood.

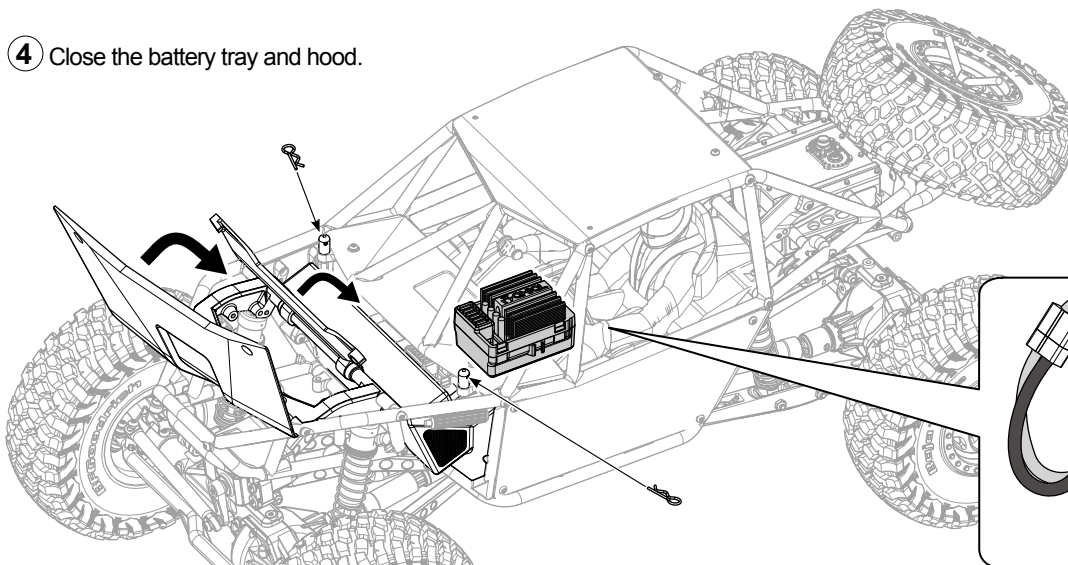

Note:
Power to the vehicle is controlled by connecting / disconnecting the battery.

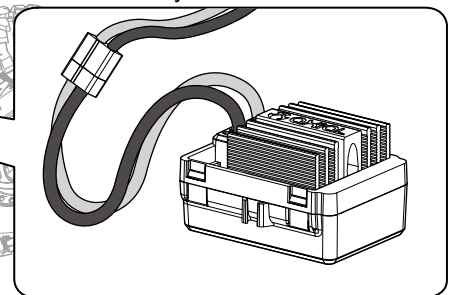

Top View Parts

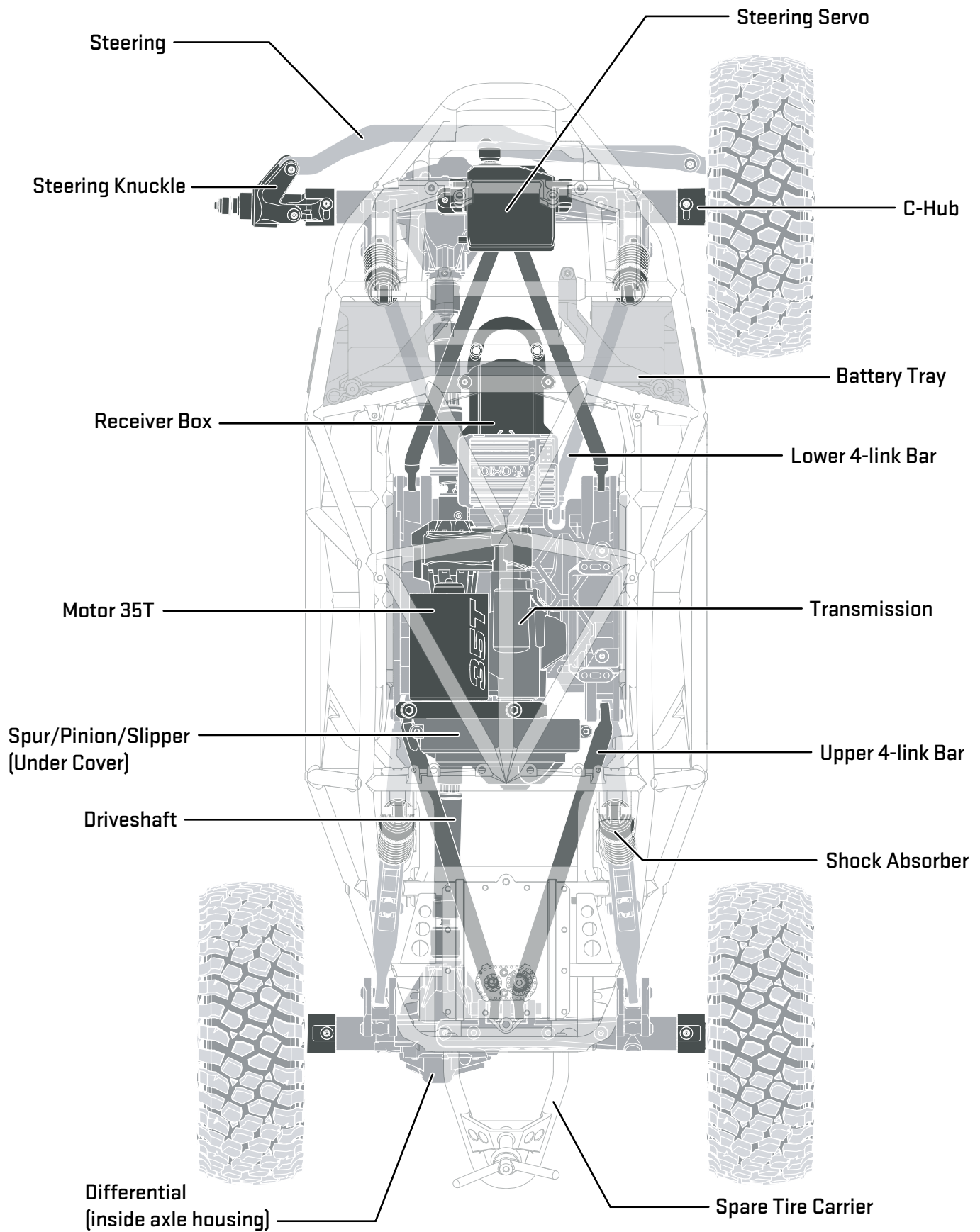

Getting-Started Checklist

The following checklist is a guide for getting you vehicle running for the first time.

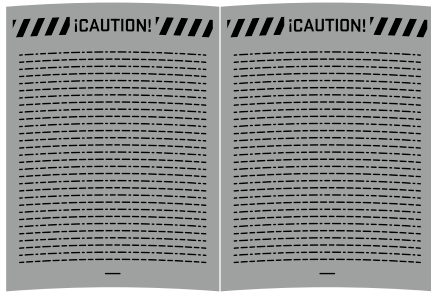

Read 'Cautions' in Manual. (Page 2)

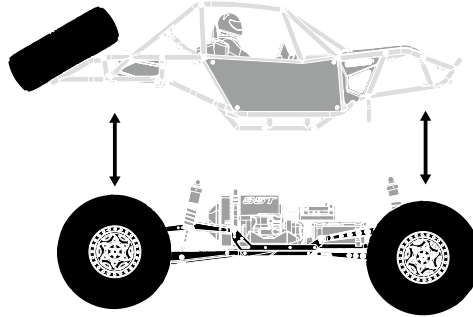

Familiarize yourself with vehicle and its components.

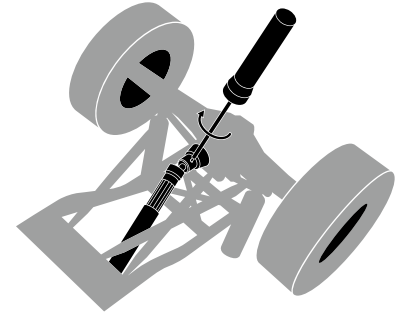

Even though the vehicle is new check driveshaft setscrews and other screws to make sure they are tight from the factory.

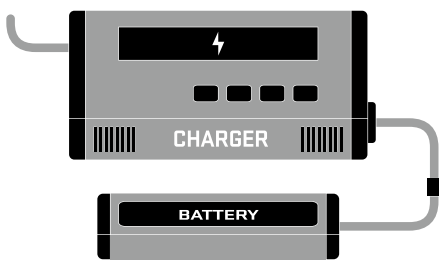

Charge battery pack. (Page 4)

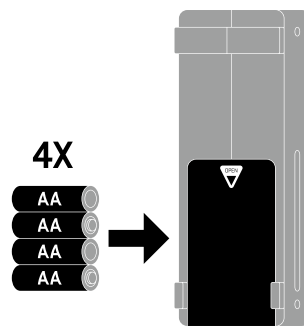

Install 4X AA batteries into Transmitter. (Page 7)

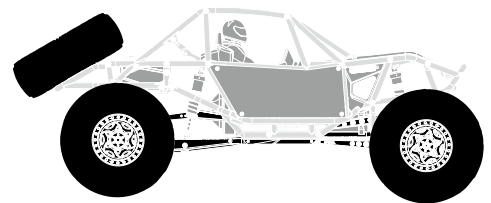

Install battery pack in vehicle. (Page 4)

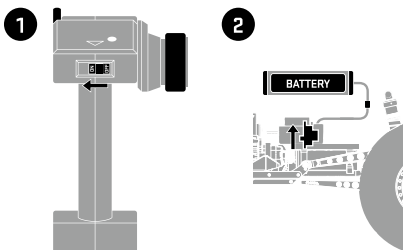

Turn on transmitter first, then plug in battery (power ESC) (Page 4)

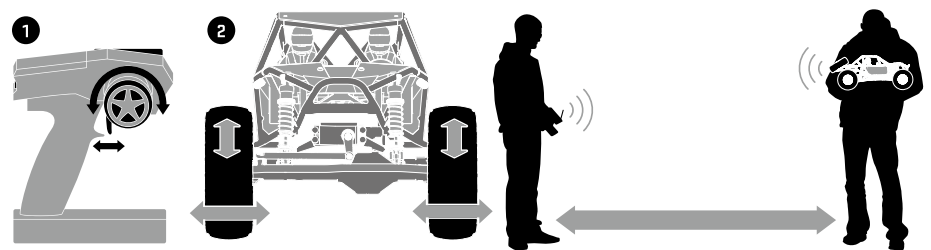

Check to make sure steering and throttle operation work correctly. (Page 7)

Range check radio system. (Next Page)

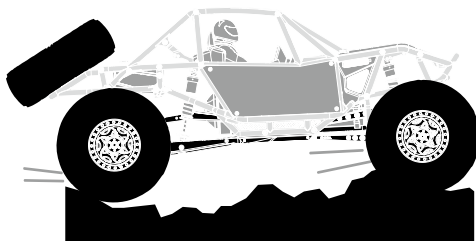

Drive vehicle, challenge yourself and have fun!

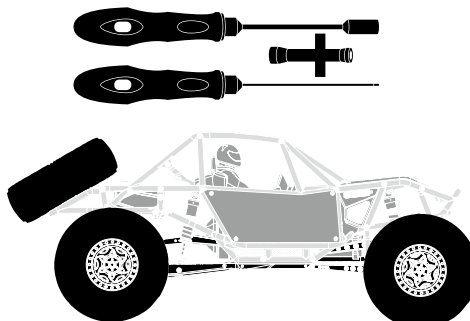

Maintain vehicle. (Next Page)

Range-Checking Your Radio System

The radio system should be checked before operating the vehicle to ensure it's operating properly and has adequate range.



1. Turn on the transmitter first and then the vehicle.
2. Have a friend hold the vehicle while keeping hands and loose clothing away from moving parts.
3. Walk away until you are at the farthest distance you plan to operate the vehicle.
4. Steer the vehicle back and forth and throttle both forward and reverse making sure there is no erratic behavior.
5. If any erratic behavior is exhibited do not operate the vehicle, call customer service for further assistance.



RANGE-CHECKING FOR DISTANCE

Maintaining Your Vehicle

Just like a full size car or truck your RC vehicle must undergo periodic maintenance in order to ensure peak running performance. Preventative maintenance will also help avoid needless breakages which could result in costly repairs. Below are some suggestions to properly maintain your vehicle.

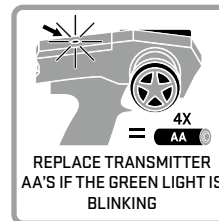
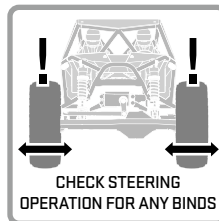
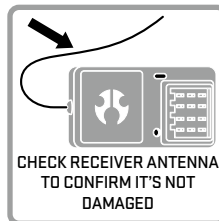
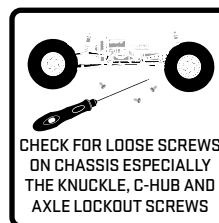
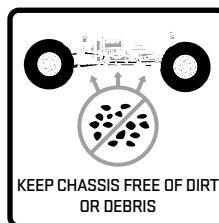
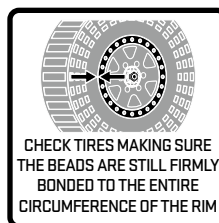
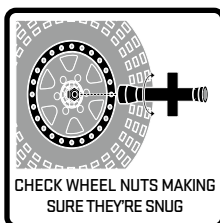
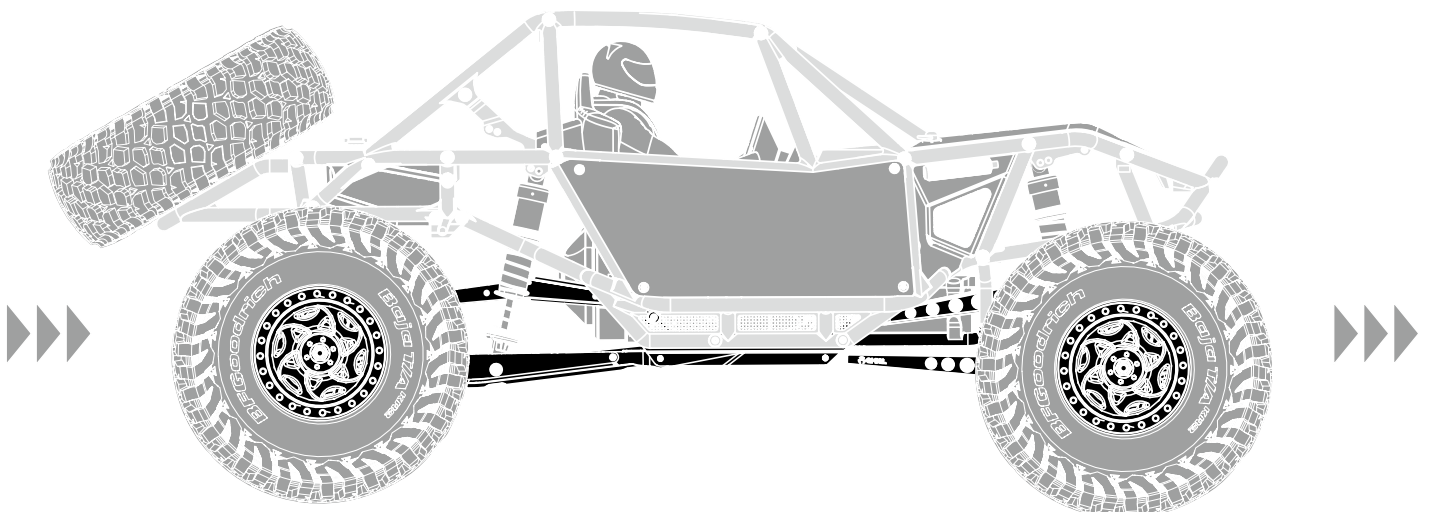
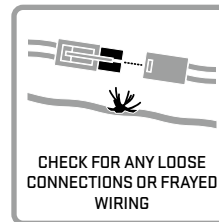
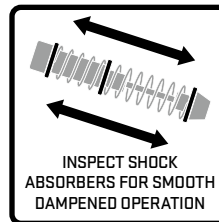
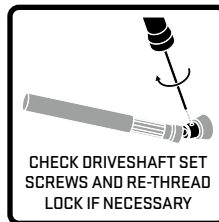
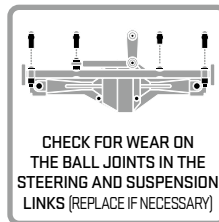
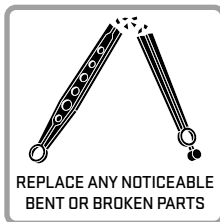

AE-5 Forward/Reverse ESC w/ Drag Brake

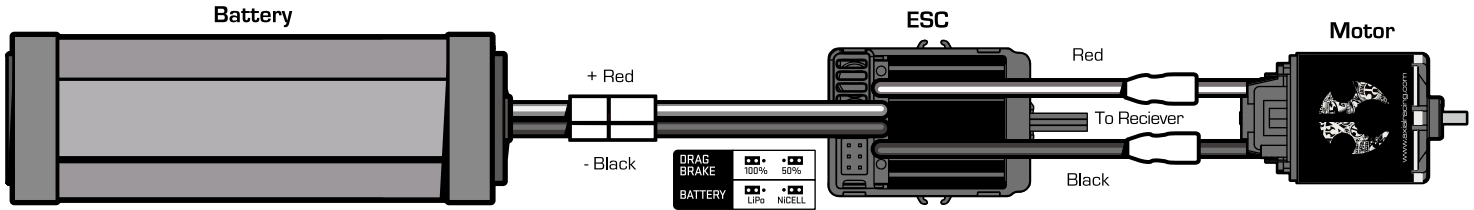

Setup:

Throttle calibration should not be needed out-of-the-box. However in order to make the throttle range of different transmitters, the calibration of the ESC is necessary:

- Mount the ESC in an area that is well ventilated and isolated from vibration and shock.
- Connect the ESC motor wires to the motor red-red & black-black.
- Plug the receiver with into the throttle channel on the receiver. The black negative wire should be towards the outside of the receiver.
- Before plugging the battery into the ESC, make sure your transmitter is on and the throttle trim is set at zero.
- Connect the battery to the ESC, this will turn on the ESC.
- Test forward and reverse control using the transmitter.
- To calibrate the ESC, make sure the transmitter is on and the throttle control is at neutral.
- Connect the battery to the ESC and wait 3 seconds to let the ESC initiate a self-test and automatic throttle calibration.

When the ESC is ready to run a long beep sound will be emitted from the motor.
Always disconnect the battery when the vehicle is not in use.

Notes:

- Drag Brake set to 100% from the factory.
- LiPo Cut-Off is set to "ON" from the factory.

Specifications:

Input Voltage:	2-3S LiPo, 5-9 Cells NiMH/NiCd
Size:	46,5mm x 34mm x 28,5mm
Weight:	70g
Motor Limit:	12T 2S / 18T 3S
On-Resistance FET:	.002
Rated/Peak Current:	180A
Braking Current:	90A
BEC Voltage/A:	5.0V 2/OA Peak
PWM Frequency:	1KHz

Beep Sound and LED Status:

1 Short Beep:	Battery is NiMH/NiCd
2 Short Beeps:	Battery is 2S Lipo
3 Short Beeps:	Battery is 3S Lipo
1 Long Beep:	Self-test and throttle calibration is OK and ESC is ready to run



CONNECT THE BATTERY PACK JUST BEFORE DRIVING AND DISCONNECT IT IMMEDIATELY AFTER.

ALWAYS MAKE SURE YOU ARE CONNECTING THE ESC TO A PROPER POWER SOURCE THAT HAS THE CORRECT VOLTAGE & POLARITY. INCORRECT VOLTAGES OR REVERSED POLARITY WILL DAMAGE THE ESC.

ONCE THE BATTERY PACK IS CONNECTED, HANDLE THE MODEL WITH EXTREME CARE, MAKE SURE YOU ARE CLEAR OF ALL ROTATING PARTS.

Roll Cage Removal

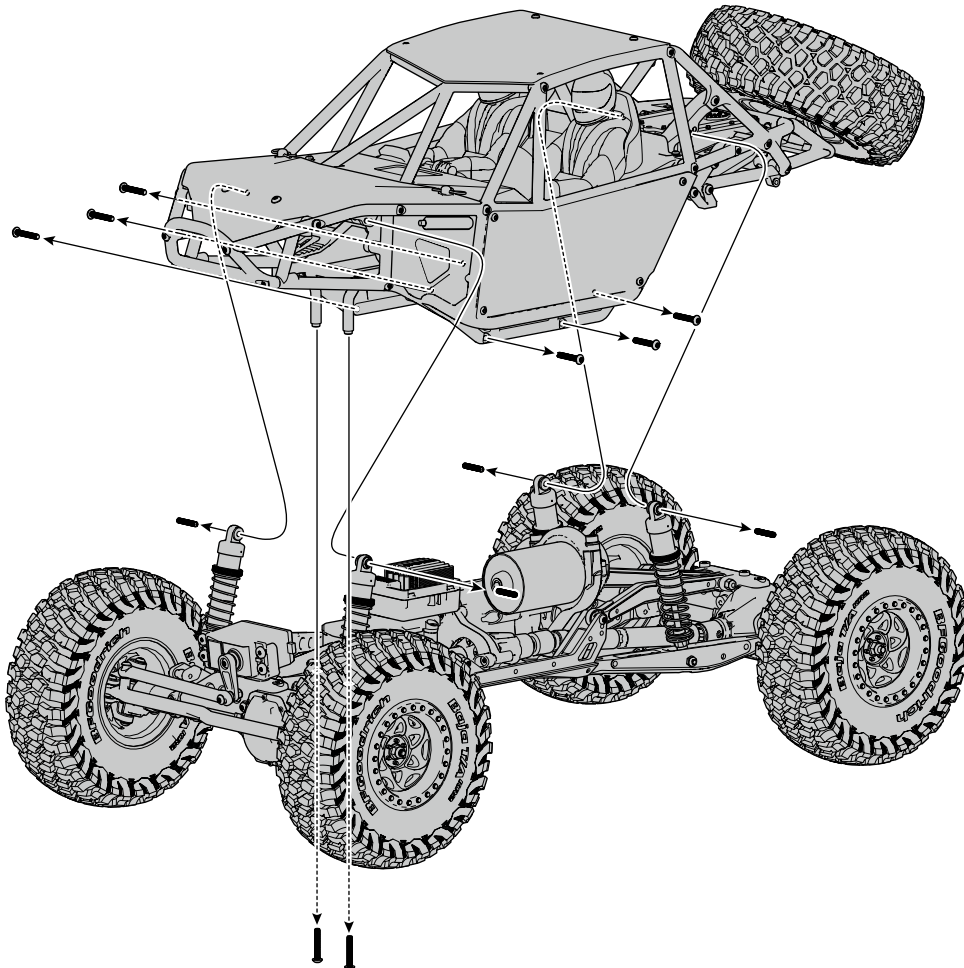

Gear Ratio / Getriebeübersetzung

Use this equation to calculate the final drive ratio.
Final Drive Gear Ratio = (Spur/Pinion)x5.67

Mit dieser Gleichung können Sie die Gesamtübersetzung berechnen.
Gesamtübersetzung = (Spur/Pinion)x5.67

Slower - More Torque
Langsamer - Mehr Kraft

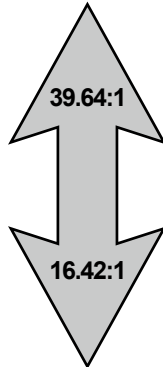

Faster - Less Torque
Schneller - Weniger Kraft

32 Pitch 38T/13T (Stock Gearing AX30392 or HD AX30395)

	Spur Gear			
Pinion	56	60	64	68
11	28.85	30.91	32.97	35.03
12	26.44	28.33	30.22	32.11
13	24.41	26.15	27.90	29.64
14	22.67	24.88	25.90	27.52
15	21.15	22.67	24.18	25.69
16	19.83	21.25	22.67	24.08
17	18.67	20.00	21.33	22.67

32 Pitch 36T/14T (Overdrive HD Gearing AX30401)

	Spur Gear			
Pinion	56	60	64	68
11	25.38	27.19	29.00	30.81
12	23.26	24.92	26.58	28.25
13	21.47	23.01	24.54	26.07
14	19.94	21.36	21.94	22.60
15	19.61	19.94	21.27	22.60
16	17.45	18.69	19.94	21.18
17	16.42	17.59	18.77	19.94

32 Pitch 43T/13T (Underdrive HD Gearing AX30402)

	Spur Gear			
Pinion	56	60	64	68
11	32.64	34.97	37.31	39.64
12	29.92	32.06	34.20	36.33
13	27.62	29.59	31.57	33.54
14	25.65	27.48	29.31	31.14
15	23.94	25.65	27.36	29.07
16	22.44	24.04	25.65	27.25
17	21.12	22.63	24.14	25.65

NOTES

Suspension Tuning - Upper Link Adjustments

•Moving the upper links at the chassis will change the anti-squat characteristics of the vehicle under power.

•RTR Stock: Front upper hole, rear middle hole.

•Optional holes, will create more or less Anti-Squat for the rear traction under power.

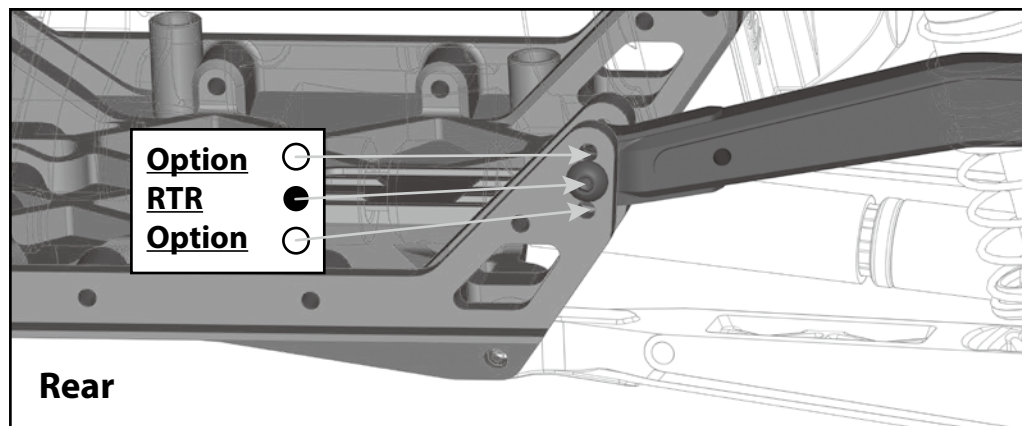
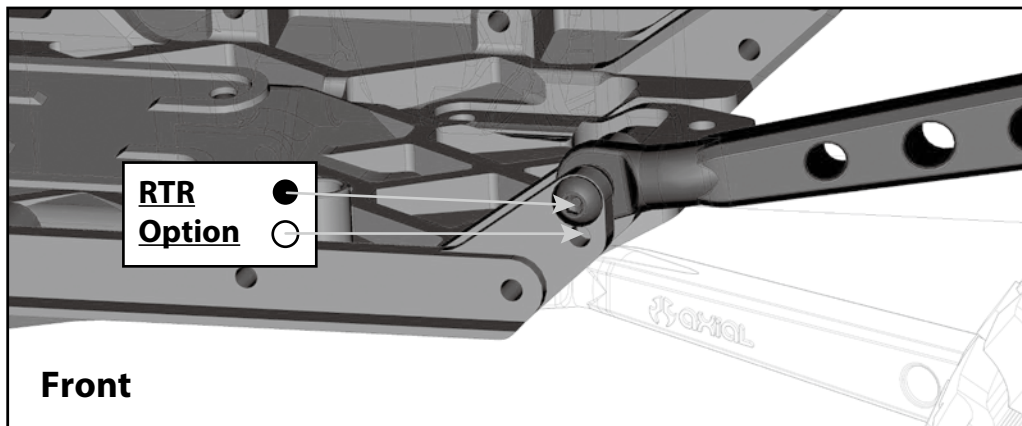

Gear Mesh Adjustment

•Remove X2 M2.6x8mm AXA0413 Flatheads from AX31107 Spur Cover to gain access to spur and pinion

•Loosen X2 M4x12mm AX31121 Capheads from AX31106 Motor Mount Clamp

•Rotate the motor and motor mount assembly to fine tune gear mesh

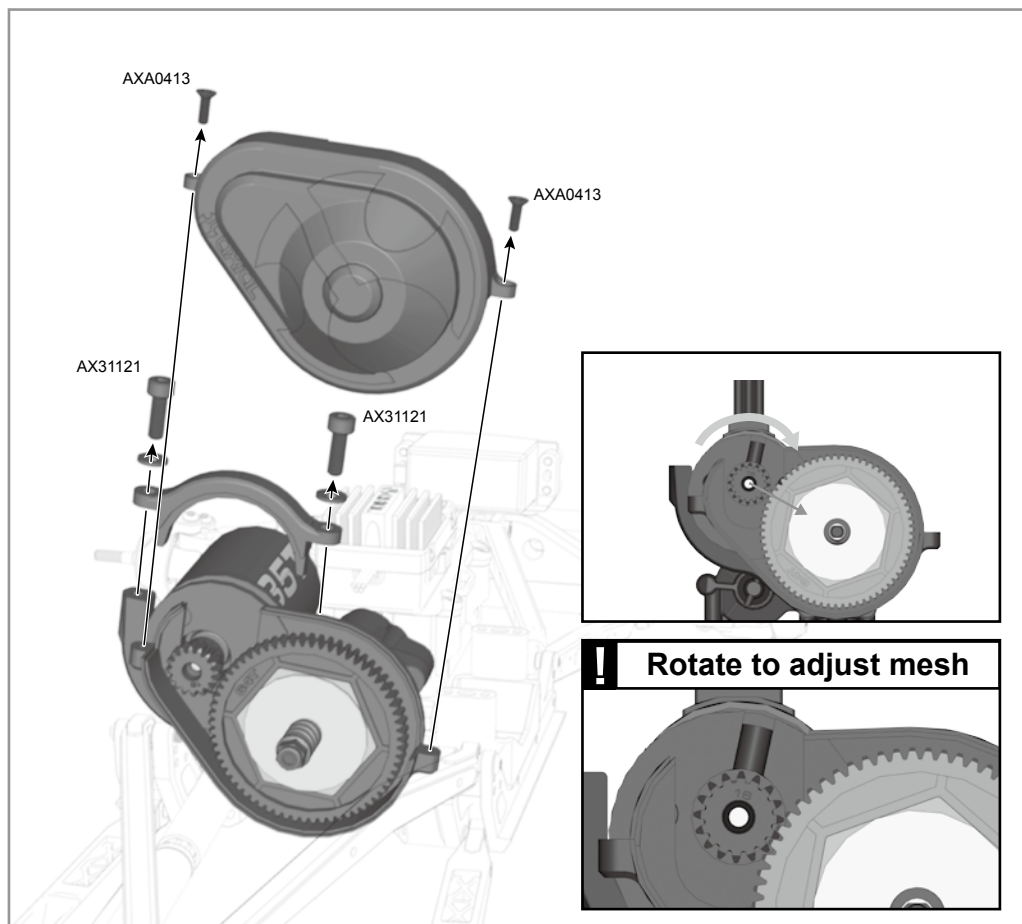

AXIAL LIMITED WARRANTY

Your Axial product is warranted to be free of defects in materials and workmanship when new in the factory sealed box. This warranty does not cover damages due to normal wear and tear, users' failure to perform routine maintenance, error of assembly or installation, modifications or addition of aftermarket parts or option parts. This warranty lasts as long as the original purchaser owns the product and is not transferable (verified by dated itemized sales receipt accompanied with product). In the event of a defect under this warranty, Axial will, at our discretion, repair or replace the product, provided our inspection indicates that an original defect exists. Axial provides a 10-day warranty from the date of purchase on electronics (i.e. servo, esc, radio). Axial reserves the right to replace any product which is no longer available with a product of comparable value and function. If Axial determines the repair is not covered under warranty guidelines, there could be a charge applied for the repair and return shipping charges. Note: Purchasing products from unauthorized distributors may void warranty and prevent support and service.

INTERNATIONAL CUSTOMER WARRANTY

Please return product to the dealer where the purchase was made. If your Axial product purchase was made through an on-line retailer, any warranty issues must be taken care of by that retailer. Axial assumes no responsibility for Axial products sold internationally by on-line retailers.

REPAIR

For warranty repair, please contact Axial Customer Service at (877) 64-AXIAL (877-642-9425).

HOURS AVAILABLE:

8:00 am - 5:00 pm Monday through Friday, Central Time.

Trouble Shooting / Fehlerbehebung / Dépannage

Problem Problem Problème	Cause Grund Cause	Remedy Lösung Remède
<p>Does not move Das Auto fährt nicht Le véhicule ne bouge pas</p>	<p>Batteries are not installed properly in the transmitter. Die Batterien sitzen nicht korrekt im Sender. Les piles ne sont pas placées correctement dans l'émetteur.</p> <p>Weak or no battery in model. Leerer oder kein Akku im Auto. Batterie faible ou non installée</p> <p>Damaged motor. Kaputter Motor. Moteur endommagé</p> <p>Frayed or broken wiring. Beschädigte Verkabelung. Câble dénudé ou coupe</p> <p>ESC is shut down by heat protection circuit. Notabschaltung des Reglers wegen Überhitzung. Le système ESC est fermé par le circuit de protection thermique.</p>	<p>Make sure batteries are properly installed. Legen Sie die Batterien korrekt ein. Positionnez correctement les piles dans l'émetteur.</p> <p>Install charged battery. Einbauen eines geladenen Akkus. Mettez en place une batterie chargée</p> <p>Replace with new motor. Austausch durch einen neuen Motor. Remplacez par un nouveau moteur</p> <p>Splice and insulate wiring completely. Erneuern und isolieren Sie die kaputte Stelle. Faites une épissure et isolez complètement le câble.</p> <p>Stop driving immediately, do not drive the car until the Speed Controller cools down. Fahren Sie nicht weiter. Warten Sie bis der Fahrten regler abgekühlt ist. Arrêtez immédiatement de conduire, ne pilotez pas la voiture tant que le contrôleur de vitesse n'a pas refroidi.</p>
<p>No Control. Keine Kontrolle über das Auto Pas de contrôle</p>	<p>Improper antenna on transmitter or model. Zu kurze Antenne am Sender oder Auto. Antenne inadéquate sur l'émetteur ou le véhicule</p> <p>Weak or no batteries in transmitter or model. Leere oder keine Batterien im Sender oder Auto. Batterie faible ou absente dans l'émetteur ou le véhicule.</p> <p>Neutral position or trim is incorrect. Neutralposition oder Trimmung sind verstellt. La position neutre est incorrecte ou le trim n'est pas réglé.</p> <p>Are the receiver and battery connections properly connected? Sind der Empfänger und die Batterieverbindungen ordentlich verbunden? Son conectadas apropiadamente las conexiones del receptor y la batería?</p>	<p>Install charged or fresh batteries. Einbauen voller Batterien. Mettez des batteries rechargées ou neuves.</p> <p>Fully extend antenna. Ziehen Sie die Antenne vollständig aus. Dépliez complètement l'antenne.</p> <p>Adjust the steering trim. Stellen Sie die Lenkungstrimmung neu ein. Réglez le trim de direction.</p> <p>Check receiver and battery connections. Prüfen Sie Empfänger und Batterieverbindungen. Compruebe conexiones de batería y receptor.</p>
<p>Steering and Throttle Function Reversed. Lenkung und Gas funktionieren genau verkehrt herum. Direction et accélération inverses.</p>	<p>Servo reverse switch is in wrong position. Servorichtungs-Schalter ist in der falschen Position. L'interrupteur de marche arrière du servo est dans la mauvaise position</p> <p>Please check that the wires from ESC to motor are connected properly. Bitte überprüfen Sie, ob die Kabel vom Regler zum Motor richtig sitzen. Veuillez vérifier que les fils allant de l'ESC au moteur sont correctement raccordés.</p>	<p>Set to correct position. Satz, Position zu korrigieren Vérifiez la position correcte</p> <p>Check to make sure motor and ESC are properly connected. Kontrolle sich zu vergewissern, dass Motor und ESC ordentlich verbunden sind. Le contrôle pour assurer que le moteur et ESC est convenablement connecté.</p>

Parts Reference / Übersicht aller Teile / Référence des pièces

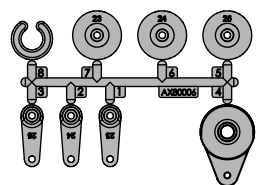

AX80006
Servo Set **x1**

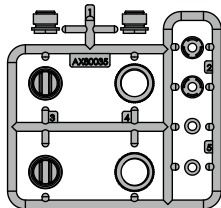

AX31301
10mm Shock Caps Parts Tree (Blue) **x2**

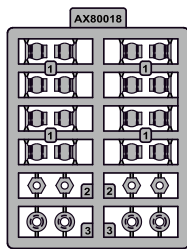

AX80018
Hardware Parts Tree **x3**



AX80071
Straight Axle Adapter Rear **x1**

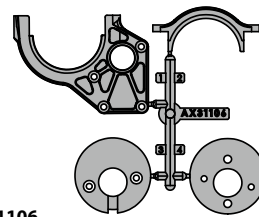

AX31106
2-Speed Hi/Lo Transmission Motor Mount **x1**

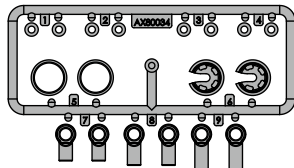

AX31300
10mm Shock Parts Tree 2 (Blue) **x2**

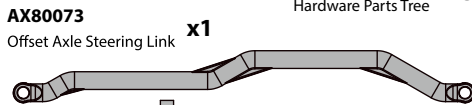

AX80073
Offset Axle Steering Link **x1**

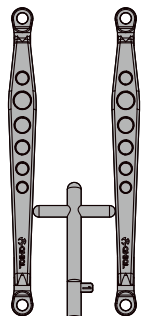

AX80083
Rock Buggy Links Set **x1**

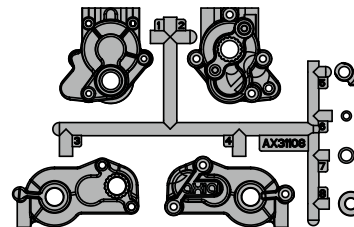

AX31108
2-Speed Hi/Lo Transmission Case **x1**

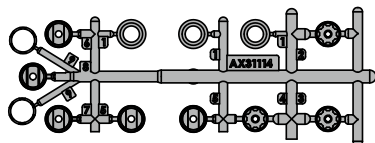

AX31114
WB8 Driveshaft **x2**

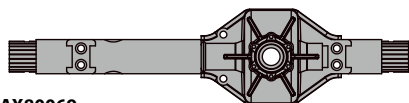

AX80069
Offset Axle Housing **x2**

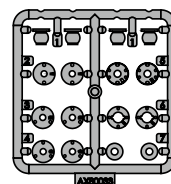

AX31065
Spur Gear 32P 64T **x1**



AX80072
Offset Axle 4 link mount **x1**

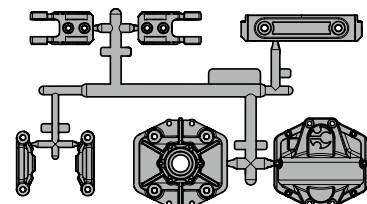

AX80062
XR10 C Hub Carrier Set **x1**

AX31318
RR10 Battery Tray Chassis Components **x1**

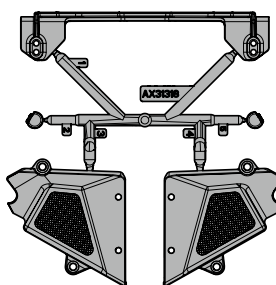

AX80033
10mm Shock Set 1 **x2**



AX80002
Diff Case - Small **x2**

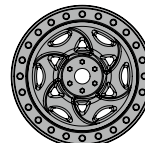

AX31326
22.2 Walker Evans Wheels **x5**



AX31316
AR60 Dual Shear Steering Knuckle Set **x1**

AX31317
AR60 Differential Cover and PTO **x1**

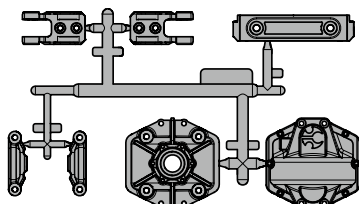

AX31333
RR10 Skid Plate **x1**

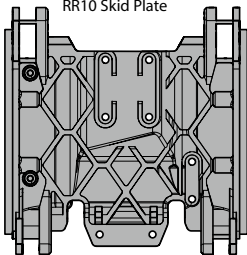

AX31332
RR10 Battery Tray Chassis Components 2 **x1**

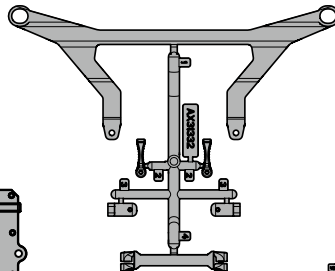

AX31107
Shifter Spur Cover **x1**

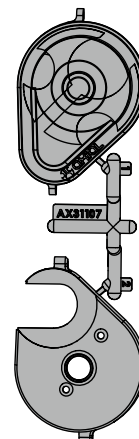

AX31109
Yeti™ Rear 4 Link Set **x1**

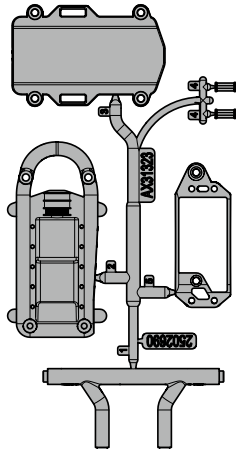
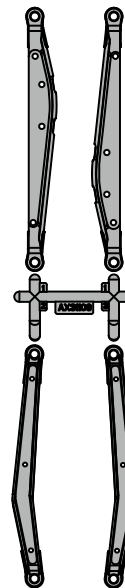

AX31323
RR10 Electronics Box Mold **x1**

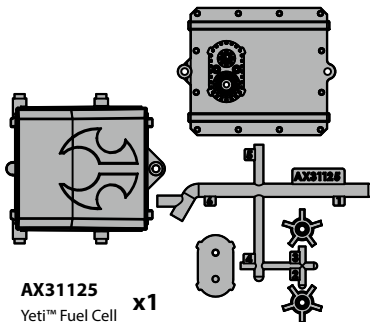

AX31125
Yeti™ Fuel Cell **x1**

AX31049
Helmet Mold (Black) **x2**

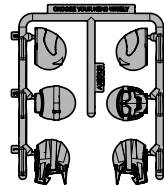

AX31324
RR10 Transfer Case Mold **x1**

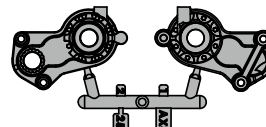

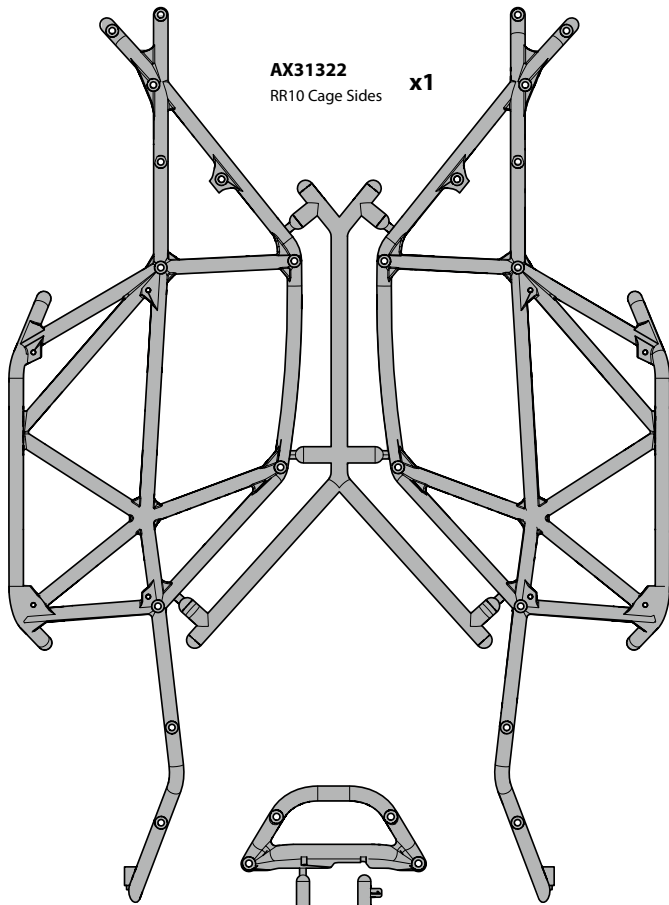

AX31322
RR10 Cage Sides **x1**

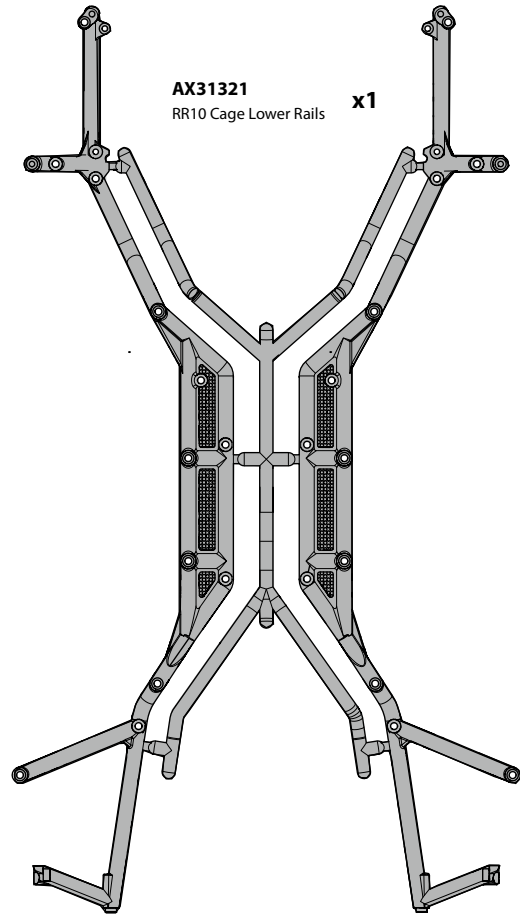

AX31321
RR10 Cage Lower Rails **x1**

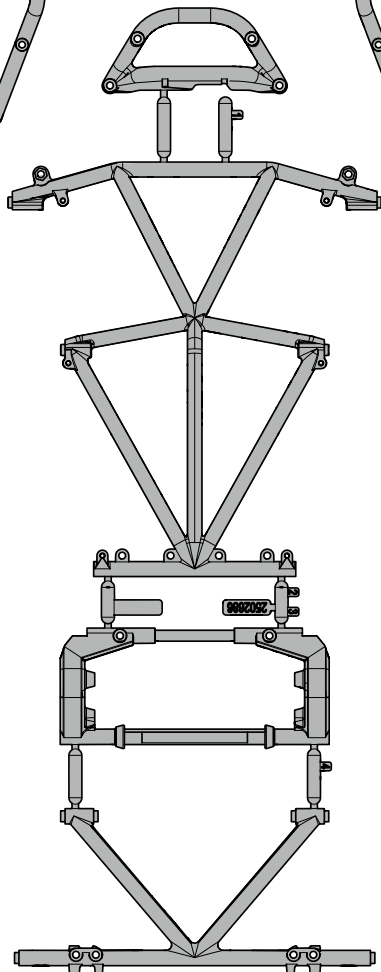

AX31319
RR10 Center Cage Mold **x1**

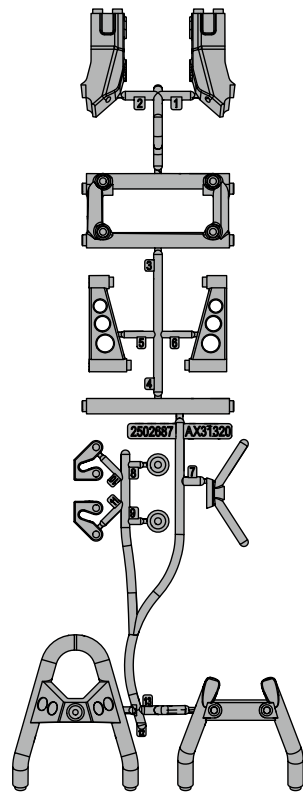

AX31320
RR10 Rear Cage Components Mold **x1**

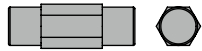

AX31131
T-Case Gear Set **x1**

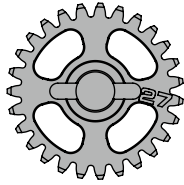

AX31131
T-Case Gear Set **x1**



X31130
High Speed Transmission
Gear Set **x1**

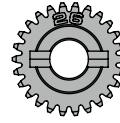

AX31130
High Speed Transmission
Gear Set **x1**



AX31131
T-Case Gear Set **x1**



AX31131
T-Case Gear Set **x1**



AX30408
Input Shaft 5x29mm **x2**



AX30113
Rubber Bump Stop 3.6x7x4 **x4**

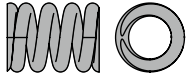

AX30413
Slipper spring **x1**

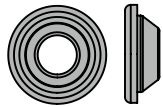

AX30112
Shock Diaphragm 13x4.5mm **x4**

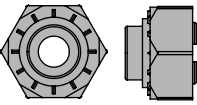

AX30429
12mm Aluminum Hub **x1**

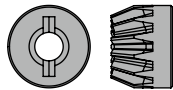

AX30392
13T Bevel Gear **x2**

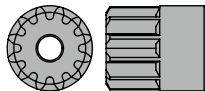

AX30723
Pinion 32DP 12T **x1**

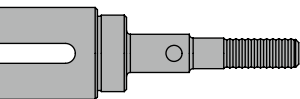

AX30368
Axle 6x39mm **x2**

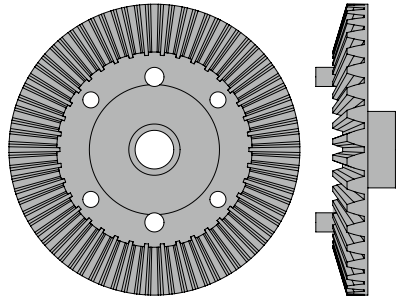

AX30392
38T Bevel Gear **x2**

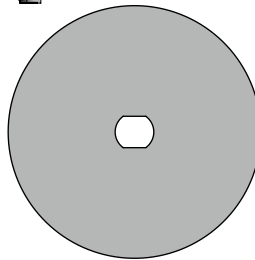

AX31059
Slipper Plate **x2**



AX31313
Transfer Case Output Shaft 5x68mm **x1**



AX30155
Shock Shaft 3x59.5 **x4**

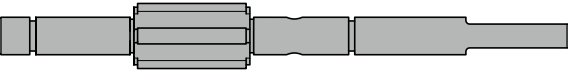

AX31129
2-Speed Hi/Lo Transmission Bottom Shaft 5x75mm **x1**



AX31127
2-Speed Hi/Lo Transmission Top Shaft 5x91mm **x1**

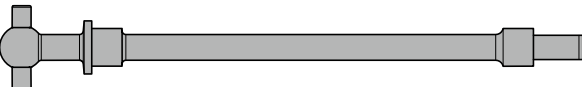

AX30419
Solid Axle Dogbone 7x69mm **x1**

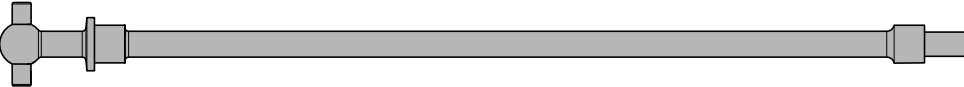

AX30419
Solid Axle Dogbone 7x125mm **x1**



AX30776
Straight Axle Shaft 6x104.2mm **x1**



AX30776
Straight Axle Shaft 6x160.2mm **x1**

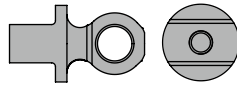

AX31148
WB8-HD Joint Male Universal **x4**

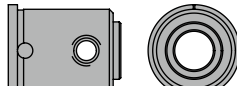

AX31148
WB8-HD Joint 10X15mm **x4**

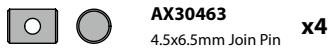

AX30463
4.5x6.5mm Join Pin **x4**



AXA0286
M4x12mm **x1**

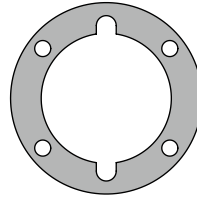

AX30385
Diff Gasket 16x25x0.5mm **x2**

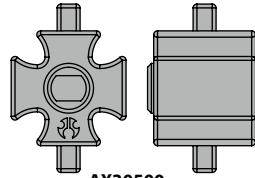

AX30500
Heavy Duty Locker **x2**

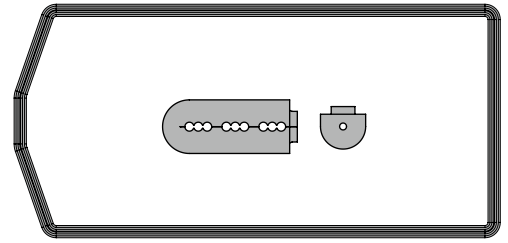

AX31083
Radio Box Seals **x1**



AX31314
Aluminum Shock Body 12x47.5mm **x4**

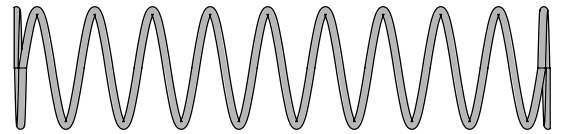

AX31315
Spring 14x70mm 1.43 lbs/in - Purple (2pcs) (Blue Springs) **x2**

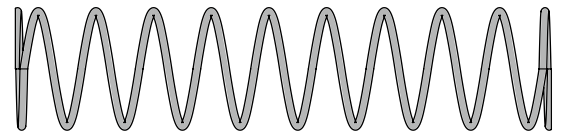

AX31336
Spring 14x70mm 3.27 lbs/in - Yellow (2pcs) (Blue Springs) **x2**

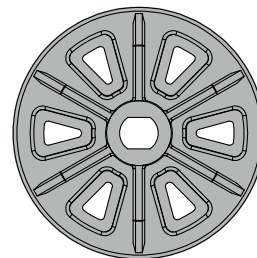

AX31067
Slipper Plate **x1**

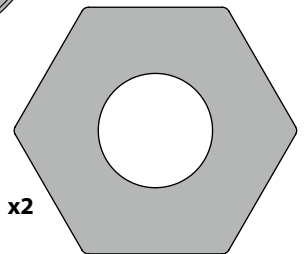

AX31068
Slipper Pad **x2**

 **AX31028**
PIN 2.0x11 **x8**

 **AX30163**
Pin 2x10mm **x5**

 **AXA1391**
E4 e-clip **x2**

 **AXA1393**
E2.5 e-clip **x2**

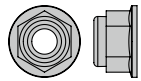
 **AX31250**
M4 Serrated Nylon Locking Nut (Black) **x4**

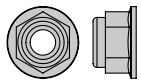
 **AXA1045**
M4 Nylon Lock Nut **x1**

 **AXA1041**
M2.5 Nylon Lock Nut **x4**

 **AXA1052**
M3 Thin Nylon Locking Hex Nut **x13**

 **AXA1053**
M3 Nylon Locking Hex Nut **x4**

 **AXA1069**
Washer 2.7x6.7x0.5 mm **x8**

 **AXA1070**
Washer 3x6x0.5 mm **x1**

 **AXA1071**
Washer 4x8x0.5 mm **x2**

 **AXA1184**
O-Ring 7.5x1.5mm **x4**

 **AXA1202**
O-Ring 3.5x2mm **x8**

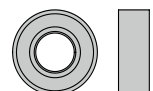
 **AXA1221**
Bearing 5x11x4mm **x21**

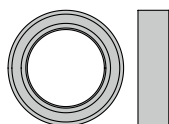
 **AXA1230**
Bearing 10x15x4mm **x6**

 **AXA180**
M3x3mm **x12**

 **AXA291**
M4x4mm **x1**

 **AXA186**
Set Screw M3x16mm **x8**

 **AXA0187**
Set Screw M3x20mm **x4**

 **AXA1059**
6mm Body Clip **x2**

 **AX30450**
Flange Pipe 3x4.5x5.5 **x4**

 **AXA0109**
M3x10mm
Oversize Flat Hex Socket **x4**

 **AXA31121**
M4x12mm Cap Head **x2**

 **AXA015**
M2x10mm **x16**

 **AXA0023**
M2.6x8mm **x4**

 **AXA087**
M3x16mm **x8**

 **AXA091**
M3x30mm **x2**

 **AXA0113**
M3x6mm **x9**

 **AXA114**
M3x8mm **x6**

 **AXA115**
M3x10mm **x14**

 **AXA116**
M3x12mm **x12**

 **AXA117**
M3x15mm **x19**

 **AXA118**
M3x18mm **x46**

 **AXA144**
M3x8mm **x10**

 **AXA31185**
M3x10mm **x2**

 **AXA146**
M3x12mm **x17**

 **AXA0147**
M3x16mm **x1**

 **AXA148**
M3x18mm **x8**

 **AXA150**
M3x25mm **x3**

 **AXA119**
M3x20mm **x1**

 **AXA121**
M3x30mm **x4**

 **AXA413**
M2.6x8mm **x2**

 **AXA0422**
M2.6x6mm **x16**

 **AXA436**
M3x12mm **x1**

 **AXA0439**
M3x20mm **x1**

 **AXA441**
M3x30mm **x4**

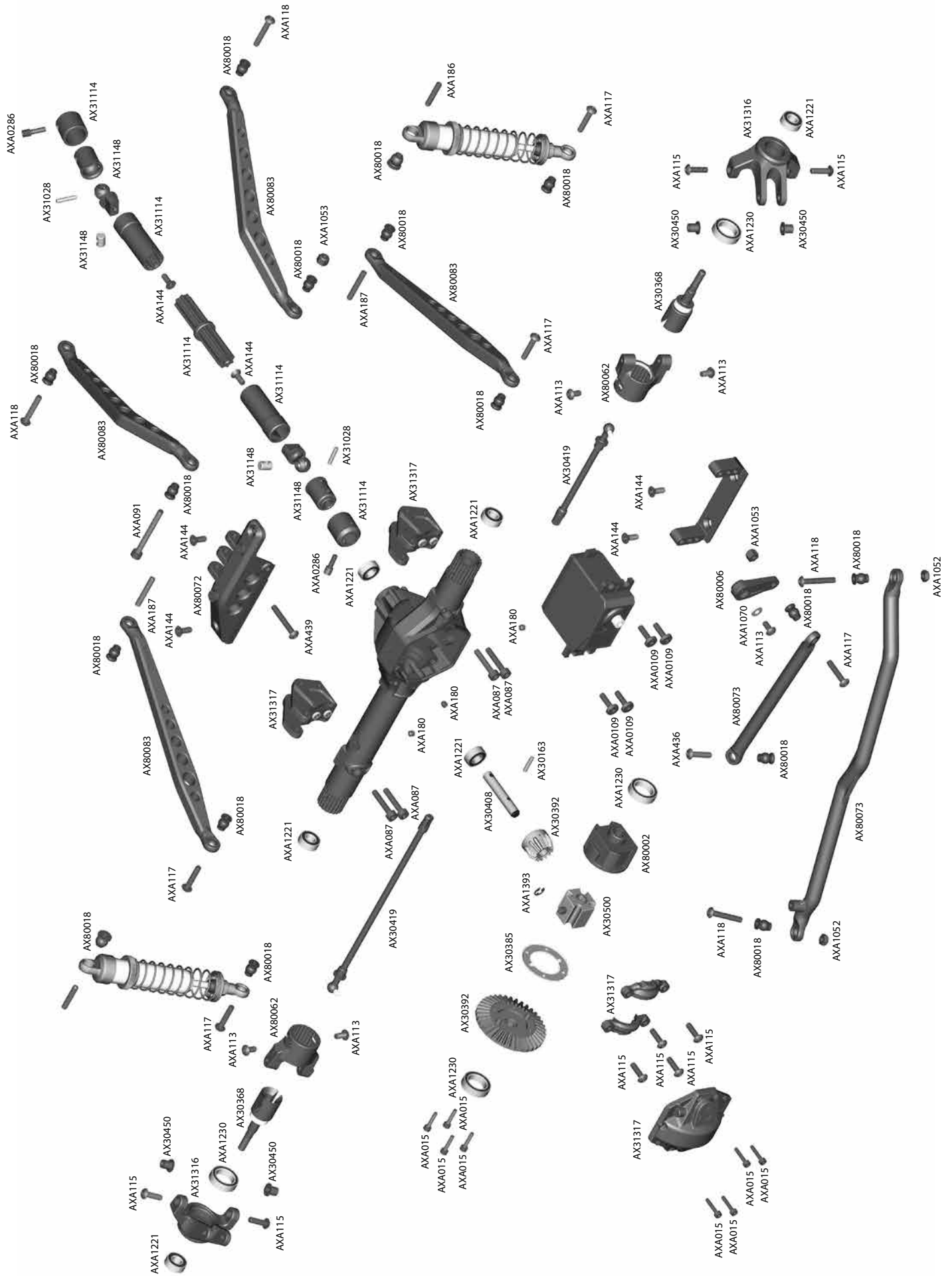

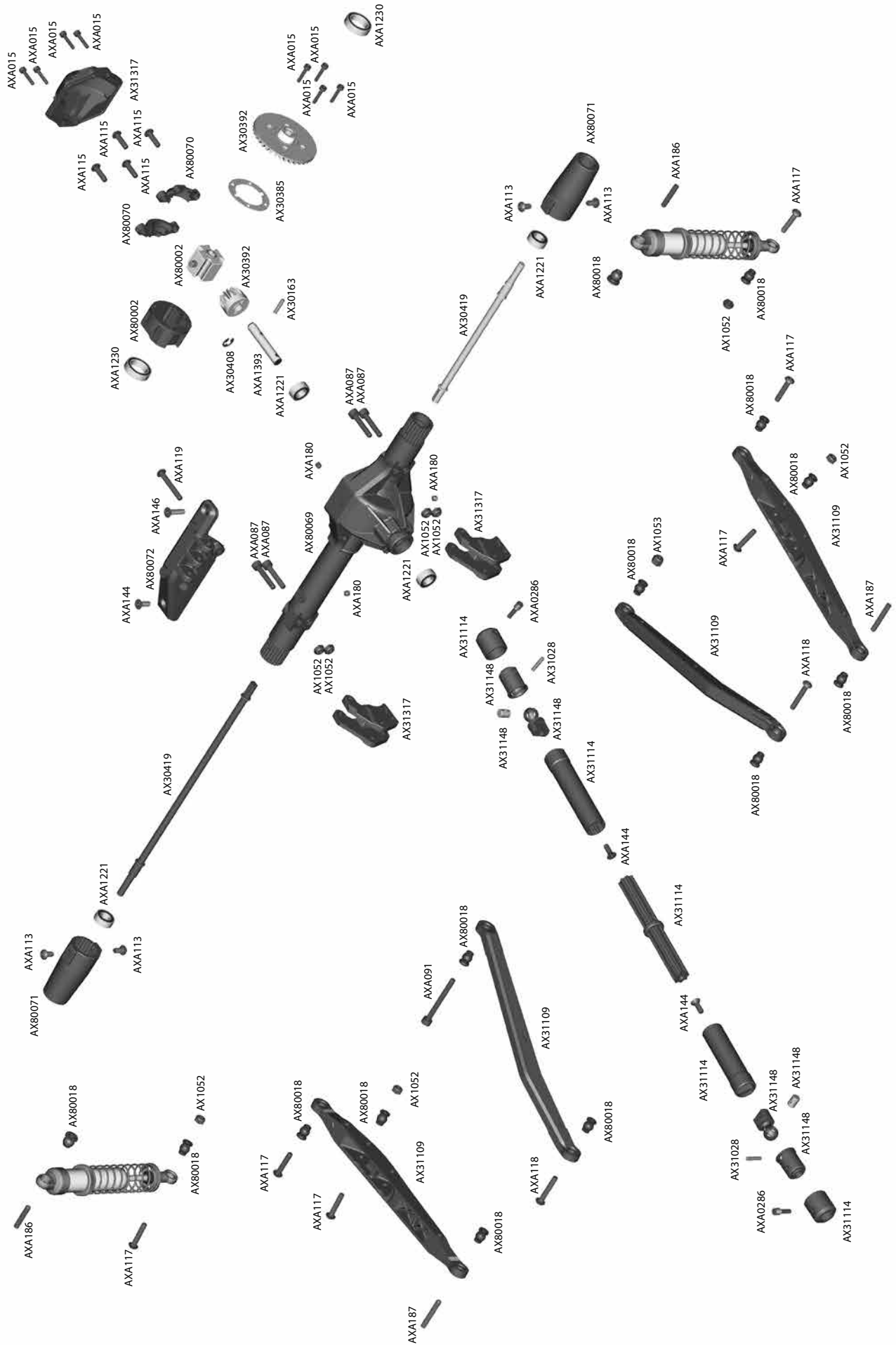

Parts List

Part #	Description	Part #	Description
AX30113	Rubber Bump Stop 3.6x7x4 (6pcs)	AXA015	M2x10mm Cap Head (Black) (10pcs)
AX30155	Shock Shaft 3x59.5 (2pcs)	AXA0187	M3x20mm Set Screw (Black) (10pcs)
AX30163	Pin 2.0x10mm (6pcs.)	AXA0286	Screw Shaft M4x2.5x12mm (6pcs)
AX30368	Axle 6x39mm (2pcs)	AXA0413	M2.6x8mm Hex Socket Tapping Flat Head (Black) (10pcs)
AX30385	Diff Gasket 16x25x0.5mm (2pcs)	AXA0439	M3x20mm Hex Socket Tapping Button Head (Black) (10pcs)
AX30392	Bevel Gear Set (38/13)	AXA087	M3x16mm Cap Head (Black) (10pcs)
AX30408	Input Shaft 5x29mm (2pcs)	AXA091	M3x30mm Cap Head - Black (10pcs)
AX30413	Slipper spring 8.5x12 165 lbs/in - Black (2pcs)	AXA1041	M2.5 Nylon Locking Hex Nut - Silver (10pcs)
AX30419	AR60 OCP Front Dogbone Set	AXA1045	M4 Nylon Lock Nut (Black) (10pcs)
AX30429	12mm Aluminum Hub (Black) (4pcs)	AXA1052	M3 Thin Nylon Locking Hex Nut (Black)
AX30450	Flange Pipe 3x4.5x5.5 (4pcs)	AXA1053	M3 Nylon Locking Hex Nut (Black) (10pcs)
AX30463	WB8 Universal Joint Rebuild Kit (2pcs)	AXA1059	6mm Body clip (Black) (10pcs)
AX30500	Heavy Duty Locker (2pcs)	AXA1069	Washer 2.7x6.7x0.5 (10pcs)
AX30723	Pinion Gear 32P 12T - Steel (3mm Motor Shaft)	AXA1070	Washer 3x6x0.5 (10pcs)
AX30776	AR60 OCP Rear Axle Set (2pcs)	AXA1071	Washer 4x8x0.5mm (10pcs)
AX31028	Pin 2.0x11mm (6pcs)	AXA114	M3x8mm Hex Socket Button Head (Black) (10pcs)
AX31049	Helmet Set (Black)	AXA115	M3x10mm Hex Socket Button Head (Black) (10pcs)
AX31059	Slipper Plate Washer 33x11mm (2pcs)	AXA116	M3x12mm Hex Socket Button Head - Black (10pcs)
AX31065	Spur Gear 32P 64T	AXA117	M3x15mm Hex Socket Button Head (Black) (10pcs)
AX31067	Slipper Plate (2pcs)	AXA118	M3x18mm Hex Socket Button Head - Black (10pcs)
AX31068	Slipper Pad 32.8x15.2x1mm (2pcs)	AXA1184	O-Ring 7.5x1.5mm (S8) - (10pcs)
AX31083	Radio Box Seals	AXA119	M3x20mm Hex Socket Button Head (Black) (10pcs)
AX31106	2-Speed Hi/Lo Transmission Motor Mount	AXA1202	O-Ring 3.5x2mm (10pcs)
AX31107	2-Speed Hi/Lo Transmission Spur Gear Cover	AXA121	M3x30mm Hex Socket Button Head (Black) (10pcs)
AX31108	2-Speed Hi/Lo Transmission Case	AXA1221	Bearing 5x11x4mm (2pcs)
AX31109	Yeti™ Rear 4 Link Set	AXA1230	Bearing 10x15x4mm
AX31114	WB8-HD Driveshaft	AXA1391	E4 e-clip (10pcs)
AX31121	M4x12mm Cap Head (Black) (10pcs)	AXA1393	E2.5 e-clip (10pcs)
AX31125	Yeti™ Fuel Cell	AXA144	M3x8mm Hex Socket Flat Head (Black) (10pcs)
AX31127	2-Speed Hi/Lo Transmission Top Shaft (5x91mm)	AXA146	M3x12mm Hex Socket Flat Head - Black (10pcs)
AX31129	2-Speed Hi/Lo Transmission Bottom Shaft (5x75mm)	AXA148	M3x18mm Hex Socket Flat Head (Black) (10pcs)
AX31130	High Speed Transmission Gear Set (48P 26T, 48P 28T)	AXA150	M3x25mm Hex Socket Flat Head (Black) (10pcs)
AX31148	WB8-HD Driveshaft Coupler Set	AXA180	M3x3mm Set Screw (Black) (10pcs)
AX31185	M3x10mm Hex Socket Flat Head (Black) (10pcs)	AXA186	M3x16mm Set Screw (Black) (10pcs)
AX31250	M4 Serrated Nylon Lock Nut (Black) (10pcs)	AXA291	M4x4mm Set Screw (Black) (6pcs.)
AX31300	10mm Shock Parts Tree 2 (Blue)	AXA436	M3x12mm Hex Socket Tapping Button Head (Black) (10pcs)
AX31301	10mm Shock Caps Parts Tree (Blue)	AXA441	M3x30mm Hex Socket Tapping Button Head (Black) (10pcs)
AX31312	35T Electric Motor		
AX31313	Transfer Case Output Shaft (5x69mm)		
AX31314	Aluminum Shock Body 12x47.5mm (Clear Anodized) (2pcs)		
AX31315	Spring 14x70mm 1.43 lbs/in - Purple (2pcs) (Blue Springs)		
AX31316	AR60 Double Shear Steering Knuckle Set		
AX31317	RR10 AR60 Axle Component Set		
AX31318	RR10 Battery Tray Chassis Components		
AX31319	RR10 Center Cage		
AX31320	RR10 Rear Cage Components		
AX31321	RR10 Cage Lower Rails		
AX31322	RR10 Cage Sides (Left and Right)		
AX31323	RR10 Electronics Box		
AX31324	RR10 Transfer Case		
AX31325	2.2 BFGoodrich Baja T/A KR2 Tires - R35 Compound (2pcs)		
AX31326	2.2 Walker Evans Wheels - Black (2pcs)		
AX31327	RR10 Bomber Body - .040" (Clear)		
AX31328	RR10 Interior Ser - .040" (Clear)		
AX31332	RR10 Battery Tray Chassis Components 2		
AX31333	RR10 Skid Plate		
AX31336	Spring 14x70mm 3.27 lbs/in - Yellow (2pcs) (Blue Springs)		
AX80002	Diff Case -Small		
AX80006	Servo Set		
AX80018	Hardware Parts Tree		
AX80033	10mm Shock Parts Tree 1		
AX80062	XR10 C Hub Carrier Set		
AX80069	AR60 OCP Axle Housing		
AX80071	AR60 OCP Straight Axle Adapter		
AX80072	AR60 OCP 4-Link Mount		
AX80073	AR60 OCP Steering Link		
AX80083	Wraith Links Set		
AXA0023	M2.6x8mm Cap Head (Black) (10pcs)		
AXA0109	M3x10mm Oversized Flat Hex Socket (Black) (10pcs)		
AXA0113	M3x6mm Hex Socket Button Head (Black) (10pcs)		
AXA0147	M3x16mm Hex Socket Flat Head (Black) (10pcs)		

Option Parts

Part #	Description	Part #	Description
AX08061	2.2 VWS Beadlock Wheels (Black) (2pcs) (Fits XR10)	AX30854	Steel Spur Gear 32P 54T
AX08069	2.2 VWS Beadlock Rings (Black) (2pcs)	AX31009	2-Speed Hi/Lo Servo Saver Set
AX08132	2.2 VWS Machined Beadlock Rings (Orange) (2pcs)	AX31047	Brushless 3150KV Electric Motor
AX08133	2.2 VWS Machined Beadlock Ring (Grey) (2pcs)	AX31069	Metal Spur Gear 32P 68T
AX08135	2.2 Raceline Renegade Wheels - 41mm Wide (Black) (2pcs)	AX31077	2.2 Falken Wildpeak M/T - R35 Compound (2pcs)
AX08137	2.2 Raceline Renegade Wheels - 41mm Wide (Chrome/Black) (2pcs)	AX31097	3 Port High Output LED Controller
AX08141	2.2 Trail Ready HD Series Beadlock w/Slim Ring - IFD™ Wheels - Black(2pcs)	AX31098	8 LED Light String (White LED)
AX08142	2.2 Trail Ready HD Series Beadlock w/Slim Ring - IFD™ Wheels - Chrome/Black(2pcs)	AX31118	2.2 Walker Evans Wheels - IFD™ Wheels - Black(2pcs)
AX12015	2.2 Ripsaw Tires - R35 Compound (2pcs)	AX31136	Icon 87-125mm Aluminum Shock Set - 10mm Piston (2pcs)
AX12021	2.2 BFGoodrich Krawler T/A - R35 Compound (2pcs)	AX31144	AE-5 Waterproof Forward/Reverse ESC w/Drag Brake
AX12022	2.2 Maxxis Trepador Tires - R35 Compound (2pcs)	AX31152	Universal Rigid Light Bar Set
AX24003	20T Electric Motor	AX31156	Machined Adjustable Motor Mount (Hard Anodized)
AX24004	Axial 27T Electric Motor	AX31160	Steel Spur Gear 32P 68T
AX24007	Axial 55T Electric Motor	AX31161	Steel Spur Gear 32P 64T
AX24010	Brushless 2900KV Electric Motor	AX31162	Steel Spur Gear 32P 60T
AX24251	Axial NVS - Night Visions System	AX31163	Steel Spur Gear 32P 56T
AX24252	Axial Double LED Light String (White LED)	AX31164	Machined Slipper Plate (Hard Anodized) (2pcs)
AX24253	Axial Double LED Light String (Red LED)	AX31171	Icon 72-103mm Aluminum Shock Set - 10mm Piston (2pcs)
AX24254	Axial Double LED Light String (Orange LED)	AX31172	Icon 67-90mm Aluminum Shock Set - 10mm Piston (2pcs)
AX24255	Axial Single LED Light String (White LED)	AX31173	Icon 93-137mm Aluminum Shock Damper Set - 10mm Piston (2pcs)
AX24256	Axial 5 LED Light String (White LED)	AX31178	2.2 Method Beadlock Wheels - IFD™ Wheels - Black(2pcs)
AX24257	Simple LED Controller w/LED lights (4 white and 2 Red)	AX31181	Yeti Transmission 2-Speed Hi/Lo Components
AX24258	4 LED Light String (White LED)	AX31184	Hi/Lo Transmission Gear Set
AX24259	Axial AE-2 Forward/Reverse ESC w/Drag Brake	AX31188	Icon Aluminum Shock Body 12x47.5mm (2pcs)
AX24260	AE-3 Vanguard ESC	AX31191	Icon Shock Cap (12mm) (2pcs)
AX30091	67-90mm Shock Set - 10mm Piston (2pcs)	AX31244	Upper Link Plate Set (Aluminum) (4pcs)
AX30092	Axial 72-103mm Shock Set - 10mm Piston (2pcs)	AX31245	Lower Link Plate Set (Aluminum) (4pcs)
AX30110	Axial Aluminum 13mm Aluminum Preload Collar (2pcs)	AX31250	M4 Serrated Nylon Lock Nut (Black) (10pcs)
AX30111	Axial Aluminum Shock Cap (2pcs)	AX31329	35T Trail Breaker Electric Motor (Rebuildable)
AX30120	Axial Aluminum Shock Body 12x47.5mm (2pcs)	AX31330	55T Trail Breaker Electric Motor (Rebuildable)
AX30155	Shock Shaft 3x59.5 (2pcs)	AX31331	RR10 Rear Sway Bar Set (Soft)
AX30218	Spring 14x70mm 2.07 lbs/in - Super Soft (Red) (2pcs)	AX80045	Axial Light Bucket Set (Black)
AX30219	Spring 14x70mm 2.47 lbs/in - Soft (White) (2pcs)	AX80047	Interior Details Parts Tree - Chrome
AX30220	Spring 14x70mm 2.85 lbs/in - Medium (Green) (2pcs)	AX80049	Axial LED Lens Set - Yellow/Clear (4pcs)
AX30221	Spring 14x70mm 3.27 lbs/in - Firm (Yellow) (2pcs)	AX80085	Universal Mount 5 Bucket Light Bar (Black)
AX30222	Spring 14x70mm 3.55 lbs/in - Super Firm (Blue) (2pcs)	AX80086	Light Bar Lenses (Clear) (5pcs)
AX30223	Spring 14x70mm 1.04 lbs/in - Black (2pcs)	AX80131	Helmet Set
AX30224	Spring 14x70mm 1.43 lbs/in - Purple (2pcs)	AX8091	Axial 2.2 Rockster Beadlocks (Black)
AX30225	Spring 14x70mm 1.75 lbs/in - Orange (2pcs)	AX8092	Axial 2.2 Rockster Beadlocks (Chrome)
AX30395	Heavy Duty Bevel Gear Set - 38T/13T	AX8095	Axial 2.2 Rockster Beadlocks (Black Chrome)
AX30401	Heavy Duty Bevel Gear Set - 36T/14T	AX8097	2.2 8 Hole Beadlocks (Black)
AX30402	Heavy Duty Bevel Gear Set - 43T/13T	AX8112	2.2 Beadlock Ring - Grey (2pcs)
AX30465	Machined hi-clearance Links - Green (2pcs)	AX8117	2.2 Rock Beadlock Ring - Grey (2pcs)
AX30468	Machined hi-clearance Links - Orange (2pcs)	AXA1076	Cap Head Washer M3x10mm (4pcs)
AX30469	Machined Hi-Clearance Links - Grey (2pcs)	AXA1101	Cone Washer 3x6.9x2mm (6pcs)
AX30545	2.2 Internal Wheel Weight Ring 57g/2oz (2pcs)	AXA1104	Cone Washer 3x6.9x2mm - Orange (6pcs)
AX30546	2.2 Internal Wheel Weight Insert 21g/0.75oz (4pcs) (for use with AX30545)	AXA1105	Cone Washer 3x6.9x2mm - Grey (6pcs)
AX30722	Pinion Gear 32P 11T (3mm shaft)	AXA1331	Flanged Ball 3x5.8x7mm (6pcs)
AX30723	Pinion Gear 32P 12T (3mm shaft)	AXA1412	0.5x6mm Spacer - Grey (6pcs)
AX30724	Pinion Gear 32P 13T (3mm shaft)	AXA1413	1x6mm Spacer - Grey (6pcs)
AX30725	Pinion Gear 32P 14T (3mm shaft)	AXA1414	2x6mm Spacer - Grey (6pcs)
AX30726	Pinion Gear 32P 15T (3mm shaft)	AXA1415	3x6mm Spacer - Grey (6pcs)
AX30727	Pinion Gear 32P 16T (3mm shaft)	AXA1416	4x6mm Spacer - Grey (6pcs)
AX30728	Pinion Gear 32P 17T (3mm shaft)	AXA1417	5x6mm Spacer - Grey (6pcs)
AX30741	Spur Gear 32P 48T	AXA1418	6x6mm Spacer - Grey (6pcs)
AX30742	Spur Gear 32P 50T	AXA1419	7x10mm Post - Grey (2pcs)
AX30743	Spur Gear 32P 52T	AXA1420	7x15mm Post - Grey (2pcs)
AX30744	Spur Gear 32P 54T	AXA1421	7x20mm Post - Grey (2pcs)
AX30762	XR10 Aluminum C-Hub Carrier (Black) (2pcs)	AXA1422	7x25mm Post - Grey (2pcs)
AX30789	AR60 OCP Aluminum Straight Axle Hub Carrier (2pcs)	AXA1423	7x30mm Post - Grey (2pcs)
AX30790	Machined Heavy Duty Aluminum Straight Link 101mm - Grey (2pcs)	AXA1424	7x35mm Post - Grey (2pcs)
AX30791	Hi-Clearance Threaded Aluminum Link 7x85mm - Grey (2pcs)	AXA1425	7x40mm Post - Grey (2pcs)
AX30829	AR60 OCP Machined Low-Profile Differential Cover	AXA1426	7x45mm Post - Grey (2pcs)
AX30830	Axial AR60 OCP Machined Link Mounts	AXA1427	7x50mm Post - Grey (2pcs)
AX30831	AR60 OCP™ Front Axle Set (Complete)	AXA1428	7x55mm Post - Grey (2pcs)
AX30834	Aluminum Servo Horn 23T	AXA1429	7x60mm Post - Grey (2pcs)
AX30835	Aluminum Servo Horn 24T	AXA1430	7x65mm Post - Grey (2pcs)
AX30836	Aluminum Servo Horn 25T	AXA1431	7x70mm Post - Grey (2pcs)
AX30851	Steel Spur Gear 32P 48T		
AX30852	Steel Spur Gear 32P 50T		
AX30853	Steel Spur Gear 32P 52T		



EXPLORE

facebook.com/axialinc | twitter.com/axialrc | youtube.com/axialvideos | flickr.com/axialrc



BFGoodrich® Tires and Baja T/A® KR2 Trademarks are used under License from Michelin
Odyssey Battery trademark(s) is/are the property of EnerSys and affiliates

AX90048-1001